

Contents

Child Safety P. 62

Exhaust Gas Hazard P. 81

Safety Labels P. 82

Opening and Closing the Tailgate P. 169
Operating the Switches Around the Steering Wheel P. 184
Interior Lights/Interior Convenience Items P. 220

Security System P. 176

Opening and Closing the Windows P. 180
Adjusting the Mirrors P. 206
Climate Control System P. 234

Audio System Basic Operation P. 270
Customized Features* P. 323

Audio Error Messages P. 315
Hands-Free Telephone System* P. 340

Hands-Free Telephone System P. 364

Off-road Guidelines P. 395
Multi-View Rear Camera* P. 519

When Driving P. 397
Refueling P. 522

Braking P. 487
Fuel Economy and CO₂ Emissions P. 526

Maintenance Schedule* P. 536
Checking and Maintaining Wiper Blades P. 576
Climate Control System* Maintenance P. 591

Maintenance Under the Bonnet P. 544
Checking and Maintaining Tyres P. 580
Cleaning P. 594

Engine Does Not Start P. 621
Indicator, Coming On/Blinking P. 633

Jump Starting P. 625
Fuses P. 639

Shift Lever Does Not Move P. 628
Emergency Towing P. 647

Devices that Emit Radio Waves* P. 659

EC Declaration of Conformity Content Outline* P. 661

Quick Reference Guide P. 2

Safe Driving P. 33

Instrument Panel P. 83

Controls P. 155

Features P. 239

Driving P. 383

Maintenance P. 527

Handling the Unexpected P. 601

Information P. 651

Index P. 662

Visual Index

Left-hand drive type

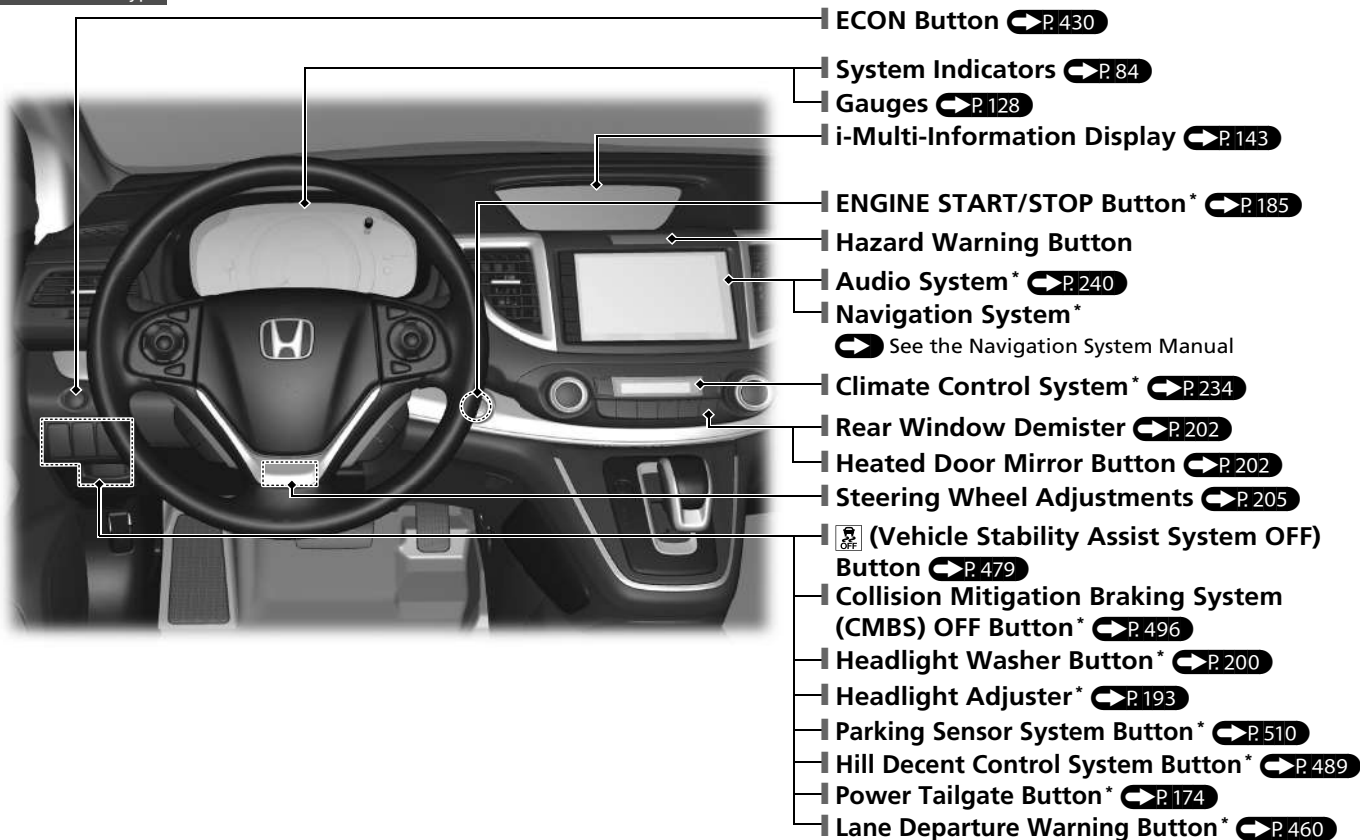

Right-hand drive type

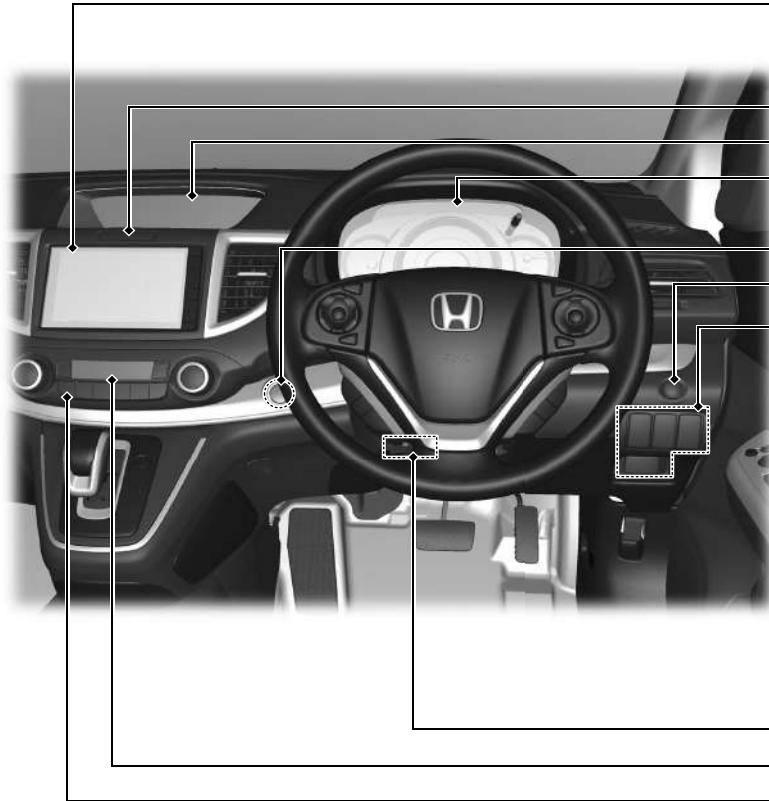

- Audio System* ➔ P.240
- Navigation System*
➔ See the Navigation System Manual
- Hazard Warning Button
- i-Multi-Information Display ➔ P.143
- System Indicators ➔ P.84
- Gauges ➔ P.128
- ENGINE START/STOP Button* ➔ P.185
- ECON Button ➔ P.430
- Headlight Washer Button* ➔ P.200
- Headlight Adjuster* ➔ P.193
- Parking Sensor System Button* ➔ P.510
-  (Vehicle Stability Assist System OFF) Button ➔ P.479
- Collision Mitigation Braking System (CMBS) OFF Button* ➔ P.496
- Hill Decent Control System Button* ➔ P.489
- Power Tailgate Button* ➔ P.174
- Lane Departure Warning Button* ➔ P.460
- Ultrasonic Sensor OFF Button* ➔ P.178
- Steering Wheel Adjustments ➔ P.205
- Climate Control System* ➔ P.234
- Rear Window Demister ➔ P.202
- Heated Door Mirror Button ➔ P.202

* Not available on all models

Visual Index

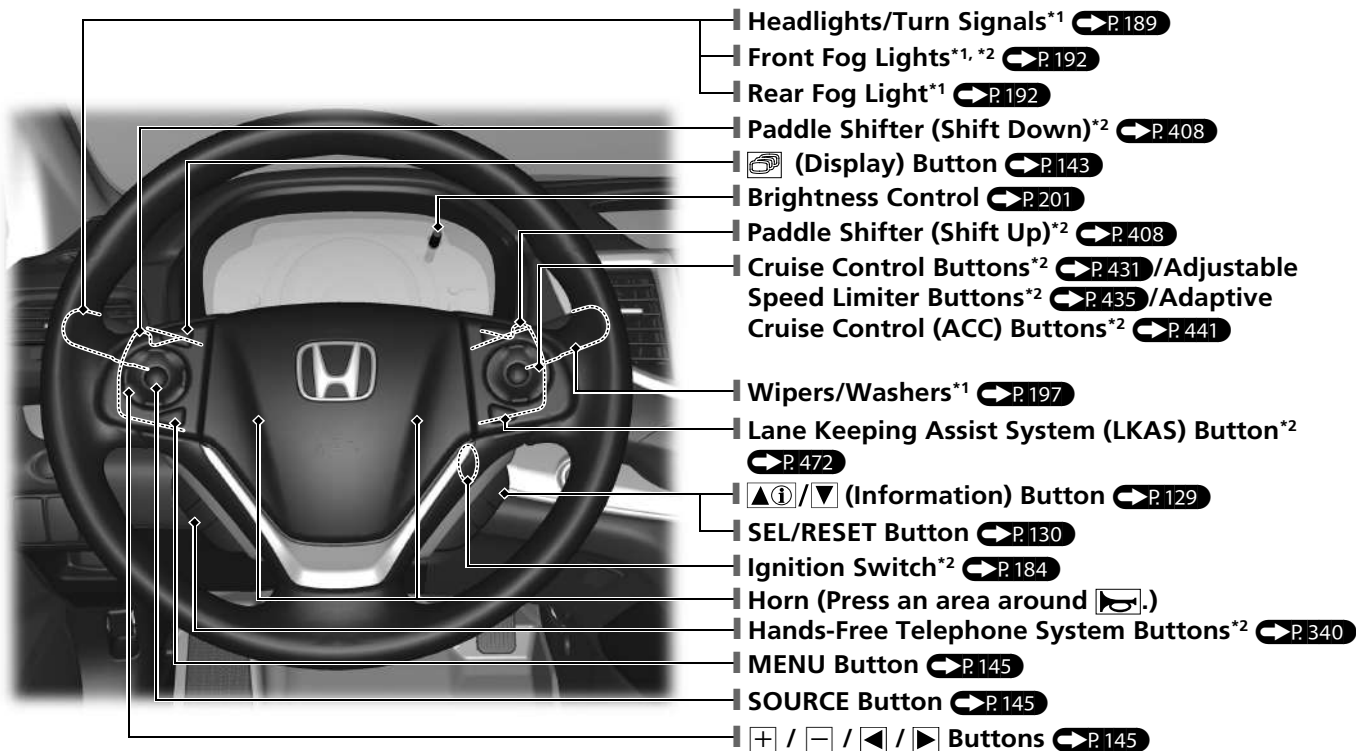

*1: Left-hand drive models shown. For the right-hand drive models, these are located at the symmetrically opposite to the left-hand drive model.

*2: Not available on all models

Left-hand drive type

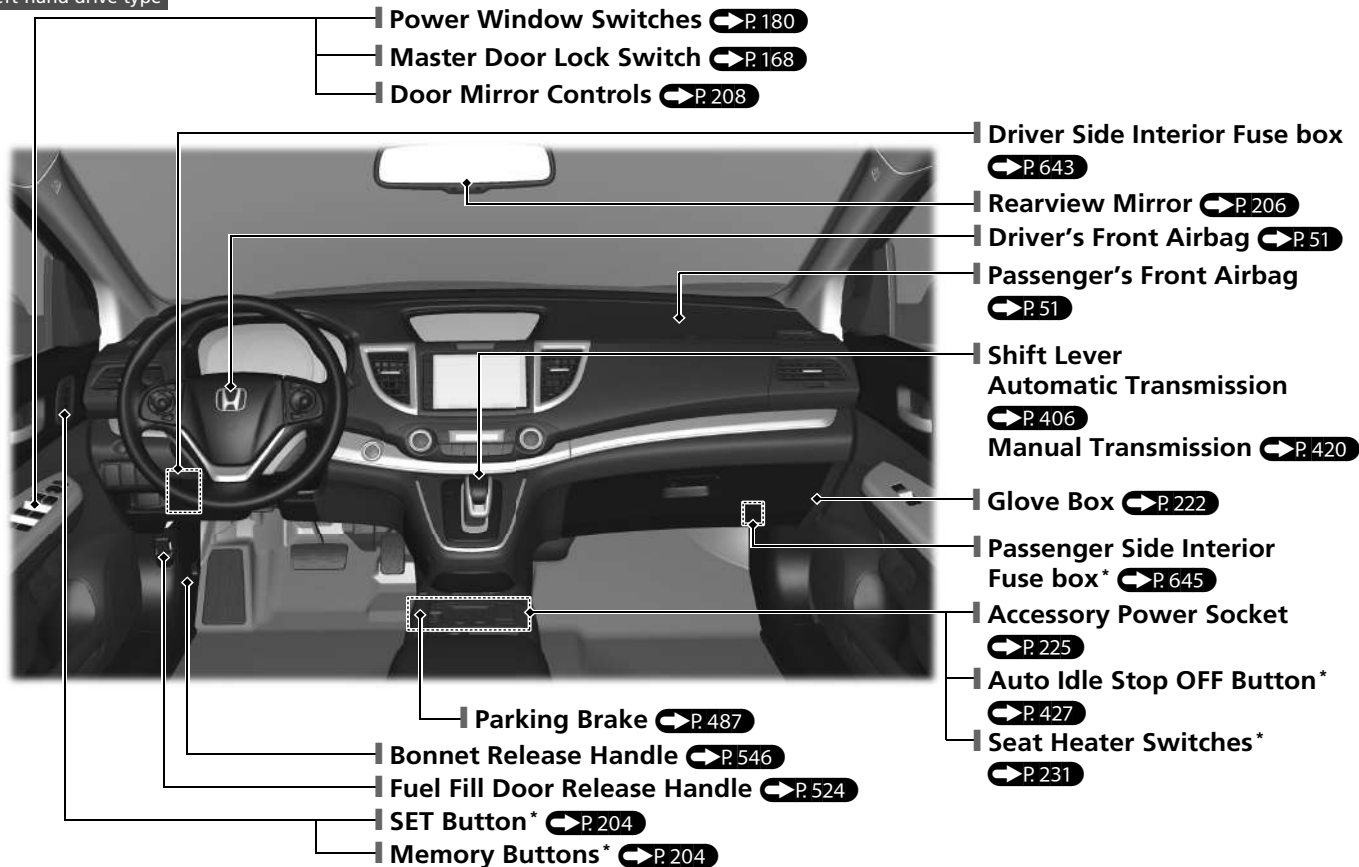

* Not available on all models

Visual Index

Right-hand drive type

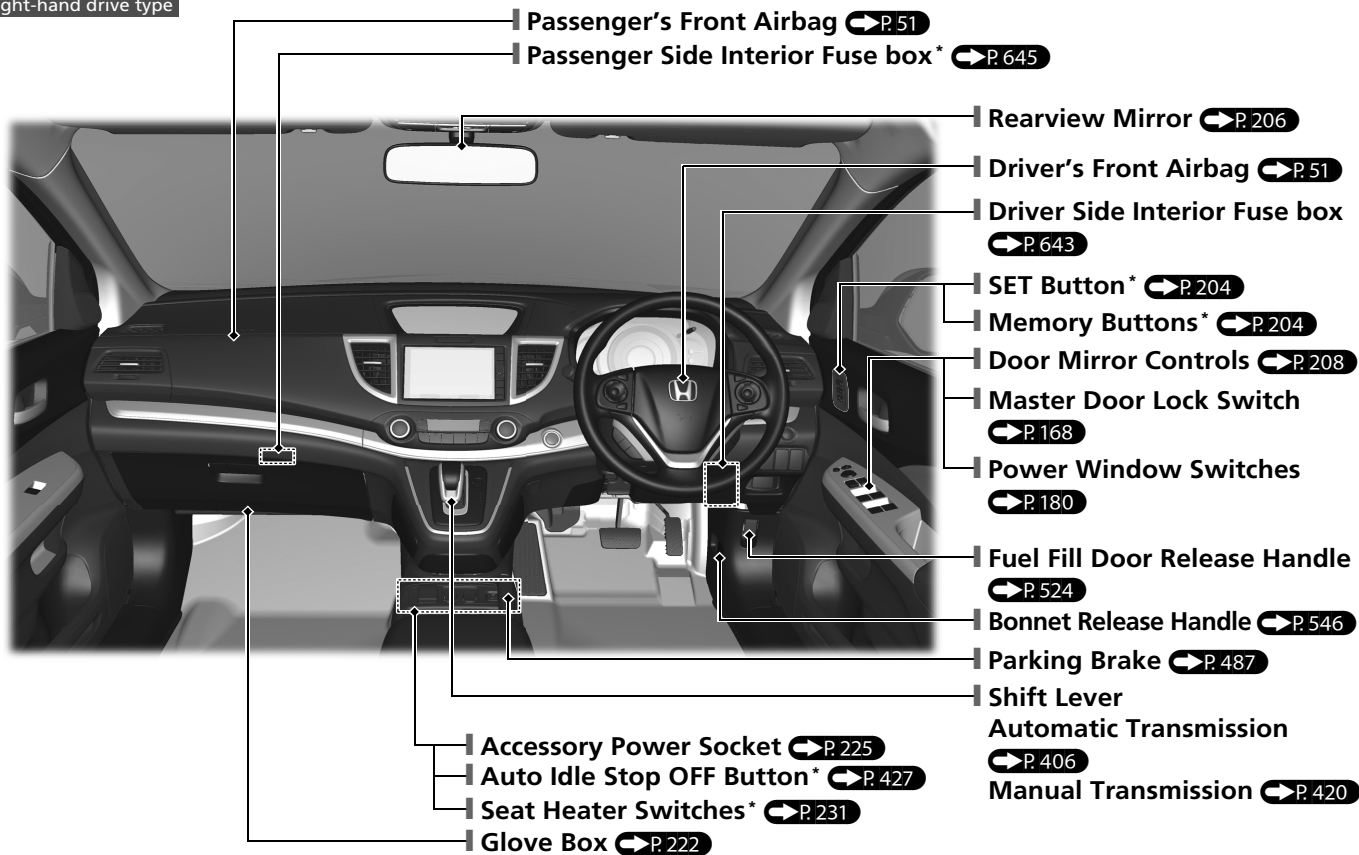

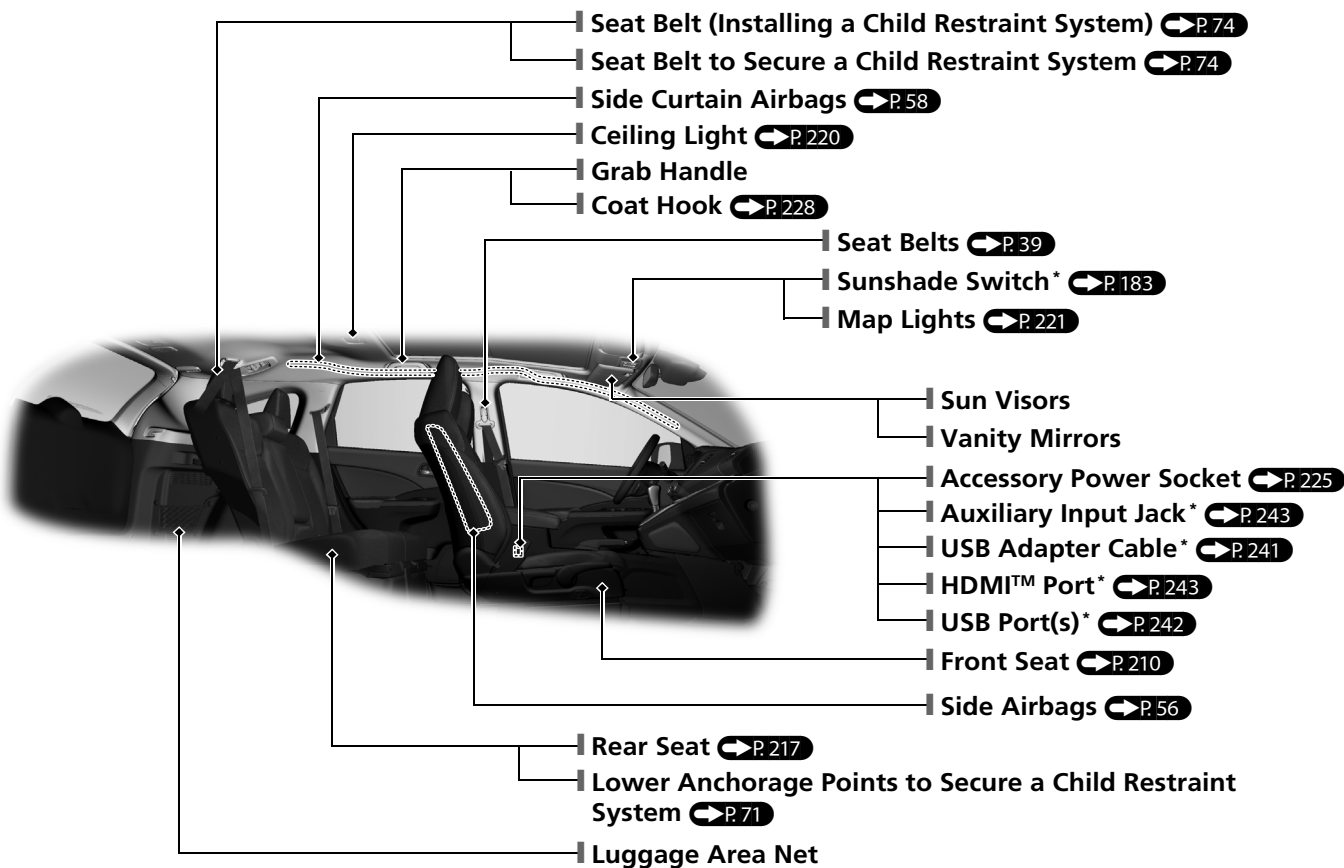

* Not available on all models

Visual Index

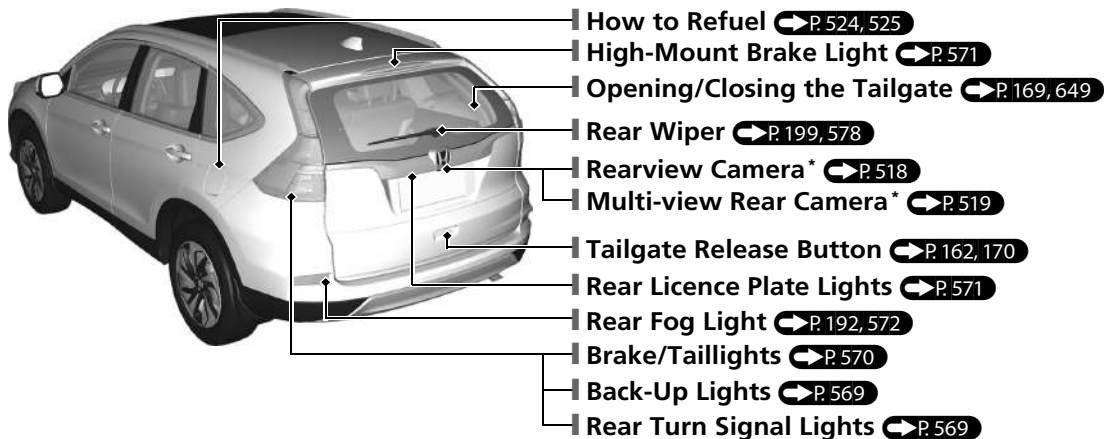
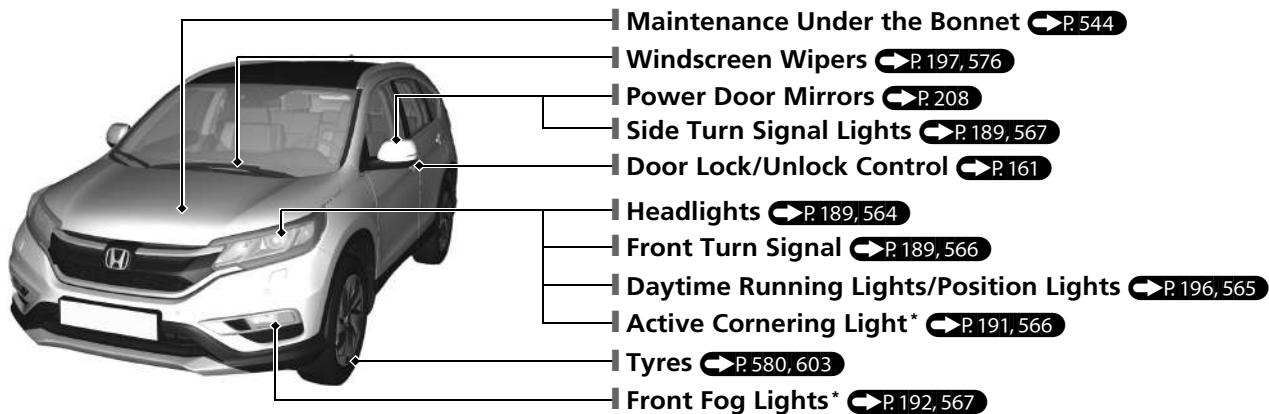

Eco Assist System

Ambient Meter

- Changes colour to reflect your driving style when the ECON mode is on.
Green: Fuel efficient driving
Yellow: Moderate acceleration/ deceleration
White: Aggressive acceleration/ deceleration

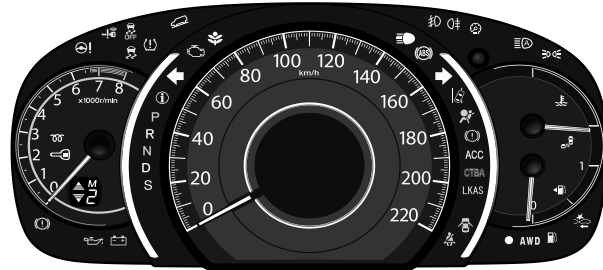

ECON Button ➔ P.430

Helps to maximize fuel economy.



ECON Mode Indicator ➔ P.97

Comes on when ECON mode is on.

The message is displayed for a few seconds when the ECON mode is turned on.

Auto Idle Stop Function *

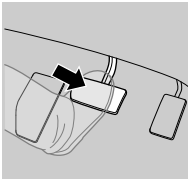
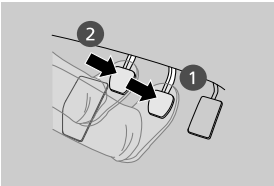
To improve fuel economy, the engine stops and then restarts as detailed below. When Auto Idle Stop is on, the Auto Idle Stop indicator (green) comes on.  P. 423, 427

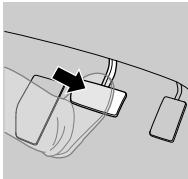
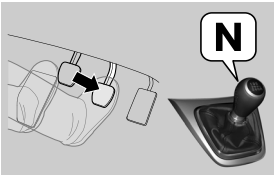
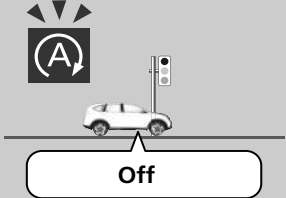
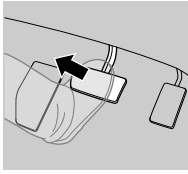
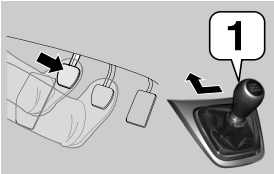
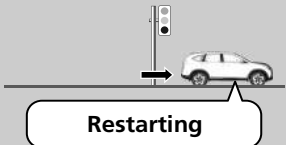
At	9-speed automatic transmission	Manual transmission	Engine status
<p>Deceleration</p> 	<p>Stop the vehicle and depress the brake pedal.</p> 	<p>1. Depress the brake pedal. 2. Fully depress the clutch pedal.</p> 	 <p>On</p>
<p>Stop</p> 	<p>Continue to depress the brake pedal.</p> 	<ul style="list-style-type: none"> Continue to depress the brake pedal. Move the shift lever to N. Release the clutch pedal. 	 <p>Off</p>
<p>Start-up</p>	<p>Release the brake pedal.</p> 	<p>1. Depress the clutch pedal again. 2. Move the shift lever to 1. 3. Depress the accelerator pedal to resume driving.</p> 	 <p>Restarting</p>

Safe Driving P.33

Airbags P.49

- Your vehicle is fitted with airbags to help to protect you and your passengers during a moderate-to-severe collision.

Child Safety P.62

- All children 12 and younger should be seated in the rear seat.
- Small children should be properly restrained in a front facing child restraint system.
- Infants must be properly restrained in a rear-facing child restraint system on a rear seat.

Exhaust Gas Hazard P.81

- Your vehicle emits dangerous exhaust gases that contain carbon monoxide. Do not run the engine in confined spaces where carbon monoxide gas can accumulate.

Seat Belts P.39

- Fasten your seat belt and sit with a correct posture.
- Check that your passengers are wearing their seat belts correctly.

Before Driving Checklist P.38

- Before driving, check that the front seats, head restraints, steering wheel, and mirrors have been properly adjusted.

















Fasten your lap belt as low as possible.

Instrument Panel ↔ P.83



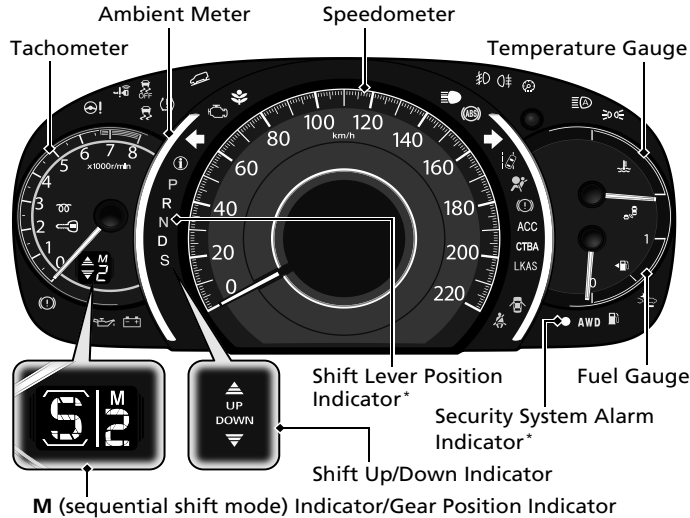

Gauges ↔ P.128 / Multi-Information Display ↔ P.129 / i-Multi-Information Display ↔ P.143 / System Indicators ↔ P.84

System Indicators





-  Hill Descent Control System Indicator*
-  VSA OFF Indicator
-  Keyless Access System Indicator*
-  Low Tyre Pressure/Deflation Warning System Indicator
-  Electric Power Steering (EPS) System Indicator
-  Vehicle Stability Assist (VSA) System Indicator
-  ECON Mode Indicator
-  Malfunction Indicator Lamp
-  System Message Indicator
-  Glow Plugs Indicator*
-  Immobilizer System Indicator
-  Charging System Indicator
-  Low Oil Pressure Indicator
-  Brake System Indicator











System Indicators

-  Auto Idle Stop Indicator (Green)*
-  Auto Idle Stop System Indicator (Amber)*
-  Anti-lock Brake System (ABS) Indicator
-  Turn Signal and Hazard Warning Indicators

Lights Indicators

-  Front Fog Light Indicator*
-  Rear Fog Light Indicator
-  High Beam Indicator
-  Lights On Indicator

System Indicators

-  Lane Departure Warning Indicator*
-  Blind Spot Information Indicator*
-  High Beam Support System Indicator*
-  Supplemental Restraint System Indicator
-  Parking Brake and Brake System Indicator
- ACC** Adaptive Cruise Control (ACC) Indicator*
-  Forward Collision Warning Indicator*/ Collision Mitigation Braking System (CMBS) Indicator*
- CTBA** City-Brake Active System (CTBA) Indicator*
- LKAS** Lane Keeping Assist System (LKAS) Indicator*
-  Door and Tailgate Open Indicator
- AWD** All-Wheel Drive (AWD) System Indicator*
-  Low Fuel Indicator
-  Seat Belt Reminder Indicator

Controls P.155

Clock P.156

Models with navigation system

The navigation system receives signals from GPS satellites, updating the clock automatically.

Models without audio system

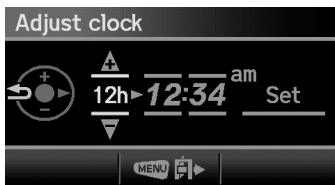

- 1 Press the **MENU** button.
- 2 Select **Adjust clock** with the \oplus / \ominus button, then press the **SOURCE** button.
- 3 Press the \oplus / \ominus button to change the setting between 12h and 24h.
- 4 Select hours or minutes with the \blacktriangleleft / \blacktriangleright button.
- 5 Press the \oplus / \ominus button to adjust the numbers up or down.
- 6 Select **Set** with the \blacktriangleleft / \blacktriangleright button, then press the **SOURCE** button to enter your selection.

Audio system with one display

- 1 Press the **CLOCK (CD/AUX)** button until the displayed time begins flashing.
- 2 Press Preset $\boxed{4}$ (Hour) or $\boxed{5}$ (Minute) to set the time. Press Preset $\boxed{6}$ (Reset) to set the time to the nearest hour.
- 3 Press the **CLOCK** button again to set the time.

Audio system with two displays

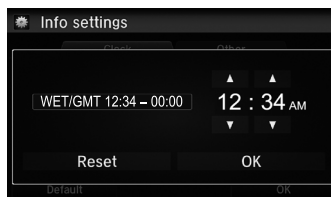

- 1 Press the **HOME** button.
- 2 Select **Settings**.
- 3 Select **Info**.
- 4 Select the **Clock** tab.
- 5 Select **Clock Adjustment**.
- 6 Select \blacktriangleup or \blacktriangledown to change hour.
- 7 Select \blacktriangleup or \blacktriangledown to change minute, then select **OK**.

ENGINE START/STOP Button * P.185

Press the button to change the vehicle's power mode.

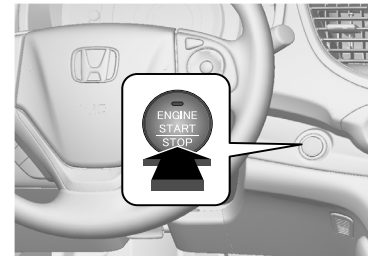

* Not available on all models

Turn Signals P.189

Turn Signal Control Lever

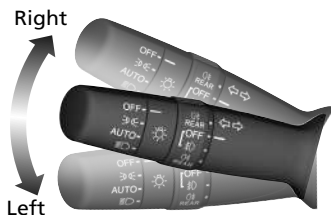

Lights P.189

Light Control Switches

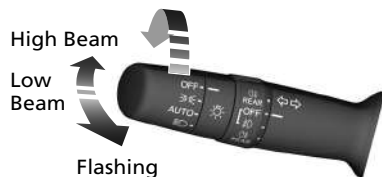

Wipers and Washers P.197

Wiper/Washer Control Lever

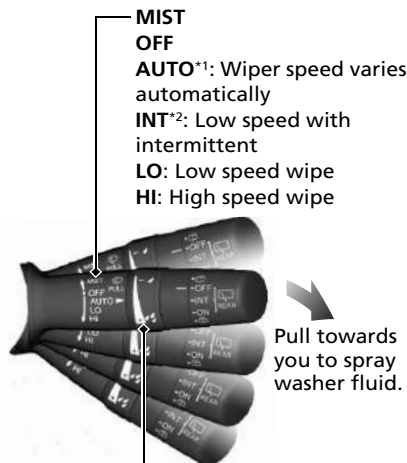

Adjustment Ring

- ☰: Low Sensitivity*¹
: Lower speed, fewer sweeps*²
- ☒: High Sensitivity*¹
: Higher speed, more sweeps*²

*1: Models with automatic intermittent wipers

*2: Models without automatic intermittent wipers

Steering Wheel P.205

- To adjust, pull the adjustment lever towards you, adjust to the desired position, then lock the lever back in place.



Unlocking the Front Doors from the Inside

 P.167

- Pull either front door inner handle to unlock and open it at the same time.

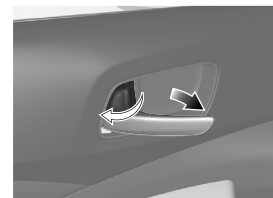

Tailgate P.169

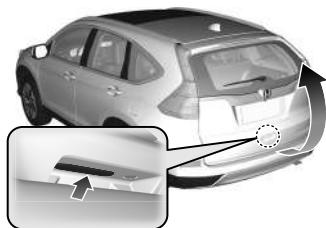

Models without keyless access system

- With all the doors unlocked, press the tailgate release button and lift open the tailgate.

Models with keyless access system

- Press the tailgate release button to unlock and open the tailgate when you carry the keyless remote.

Models with power tailgate

- Press the power tailgate button on the driver side control panel or the remote transmitter to open and close the power tailgate.

Power Door Mirrors

P.208

- With the ignition switch in ON ^{*1}, move the selector switch to L or R.
- Push the appropriate edge of the adjustment switch to adjust the mirror.
- Press the folding button* to fold in and out the door mirrors.

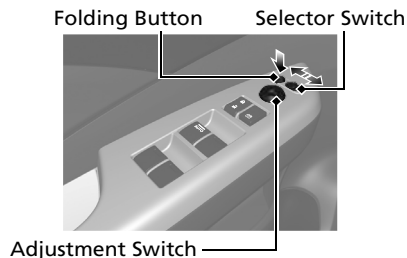

*1: Models with the keyless access system have an **ENGINE START/STOP** button instead of an ignition switch.

Power Windows P.180

- With the ignition switch in ON ^{*1}, open and close the power windows.
- If the power window lock button is in the off position, each passenger's window can be opened and closed with its own switch.
- If the power window lock button is in the on position (indicator on), each passenger's window switch is disabled.

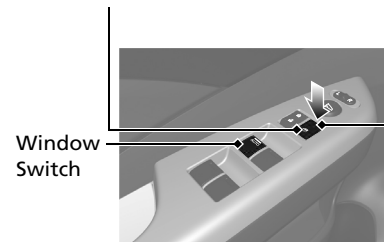

Power Window Lock Button Indicator



*1: Models with the keyless access system have an **ENGINE START/STOP** button instead of an ignition switch.

* Not available on all models





Climate Control System*

- Press the **AUTO** button to activate the climate control system.
- Press the  button to turn the system on or off.
- Press the  button to defrost the windscreen.

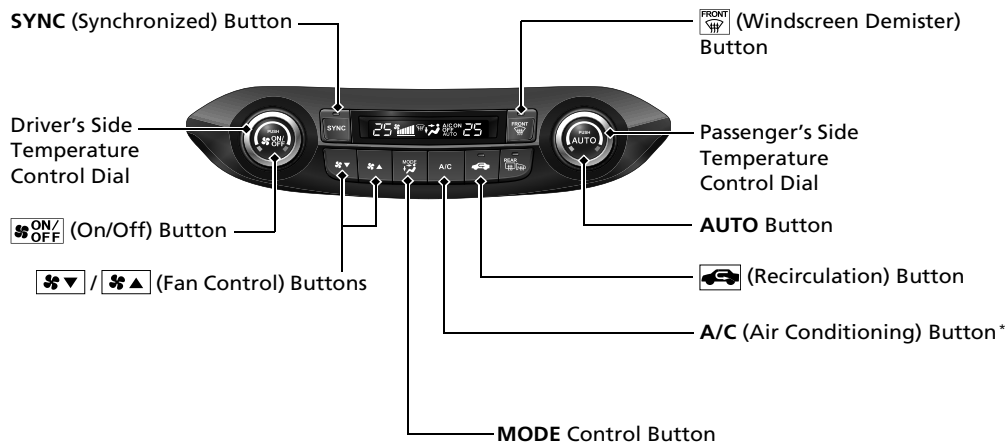
Models with navigation system

The climate control system is voice operable. See the Navigation System Manual for complete details.



-  Air flows from dashboard vents, and back of the centre console*.
-  Air flows from floor and dashboard vents, and back of the centre console*.
-  Air flows from floor vents.
-  Air flows from floor and windscreen demister vents.

Features ↔ P.239

Audio Remote Controls

↔ P.245

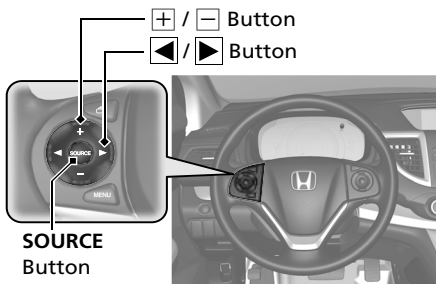

- **+ / - Button**
Press to adjust the volume up/down.
- **SOURCE Button**

Audio system with one display

Press to change the audio mode: FM1/ FM2/DAB1*/DAB2*/LW/MW/CD/AUX.

Audio system with two displays

Press to change the audio mode: FM/LW/ MW/DAB/CD*/USB/iPod/Apps/Bluetooth® Audio/AUX HDMITM.

- **◀ / ▶ Button**
Radio: Press to change the preset station.
Press and hold to select the next or previous strong station.

CD/USB device:

Press to skip to the beginning of the next song or return to the beginning of the current song.
Press and hold to change folder.

Audio system* ↔ P.240

Audio system with one display

i-Multi-Information Display

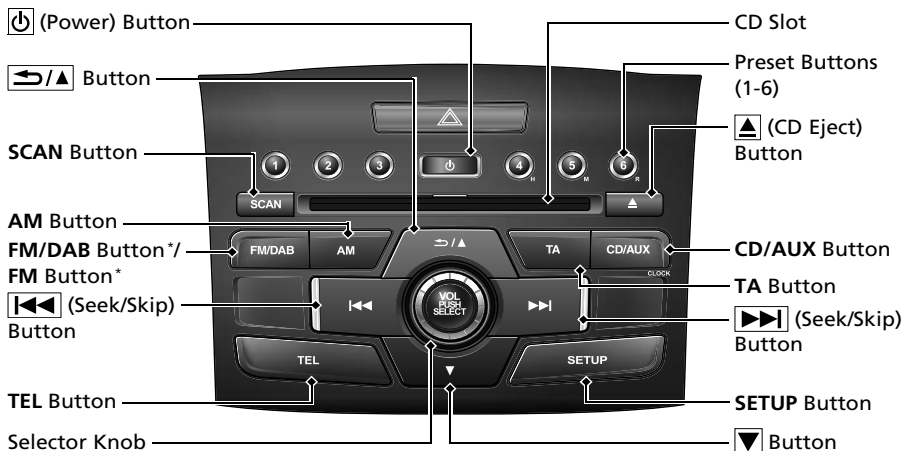
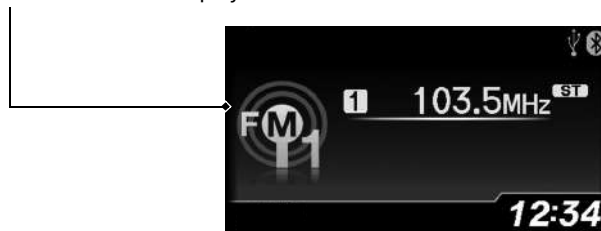

* Not available on all models





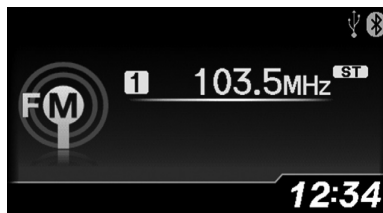
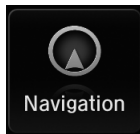

Audio system with two displays

For navigation system operation  See the Navigation System Manual





i-Multi-Information Display

Models with navigation system

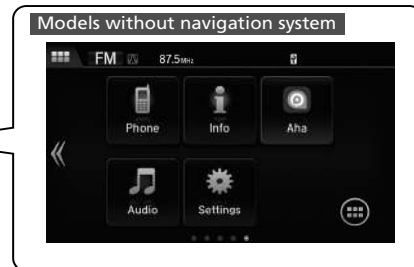
-  (Power) Button
-  (Home) Button
- VOL (Volume) Buttons
-  (Menu) Button
-  (Back) Button
-  Button
-  (Eject/CLOSE) Button*



Audio/Information Screen

Press the  (Eject/CLOSE) button to open the screen.
 Press the  (Eject/CLOSE) button to return the screen to the upright position.



 (Eject/CLOSE) Button*

Driving ↔ P. 383

Manual Transmission ↔ P. 420

5-speed automatic transmission models

Automatic Transmission ↔ P. 406

- Shift to **P** and depress the brake pedal when starting the engine.

Shifting

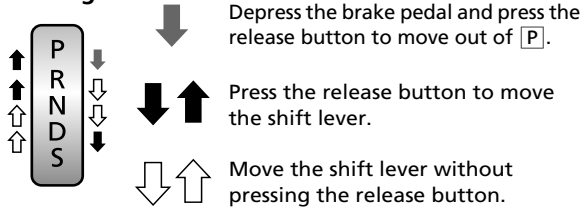

- P** **Park**
Turn off or start the engine.
Transmission is locked.
- R** **Reverse**
Used when reversing.
- N** **Neutral**
Transmission is not locked.
- D** **Drive**
Normal driving.
D-paddle shift mode can be used.
- S** **S Position**
Sequential shift mode can be used.

Paddle Shifters ↔ P. 408

- Paddle shifters allow you to shift gears much like a manual transmission (1st through 5th). This is useful for engine braking.
- D-paddle shift mode: The transmission will shift back to automatic mode once the system detects that the vehicle is cruising.
- Sequential shift mode: Holds the selected gear, and the **M** indicator comes on.

Gear Position Indicator

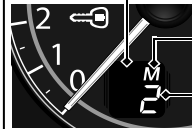

M Indicator
Selected Gear Number

Paddle Shifter (-)



Paddle Shifter (+)

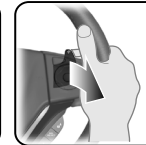

- The selected gear position is shown in the instrument panel.

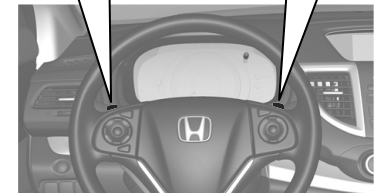

9-speed automatic transmission models

Automatic Transmission P.411

- Select to **P** and depress the brake pedal when starting the engine.

Shifting

Gear position indicator

The selected gear position is shown in the gear position indicator and shift lever indicator.

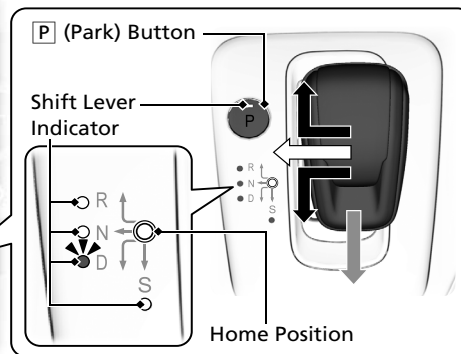

P **Park**
Used when parking or starting the engine.

R **Reverse**
Used when reversing.

N **Neutral**
Used when idling.

D **Drive**
Used:
Normal driving.
D-paddle shift mode can be used.

S **S Position**
Sequential shift mode can be used.

 Press the **P** (Park) button to change to **P**.

 Move the shift lever in the direction of the arrow to change to **R** or **D**.

 Slide the shift lever to the driver side and hold it for a while to change to **N**.

 **S** is only available when the transmission is in **D**.
Change the gear position to **D**, then move the shift lever in the direction of the arrow to change to **S**.

The shift lever automatically returns to Home position as you release it.

Paddle Shifters  **P. 417**

- Paddle shifters allow you to shift gears much like a manual transmission (1st through 9th). This is useful for engine braking.
- D-paddle shift mode: The transmission will shift back to automatic mode once the system detects that the vehicle is cruising.
- Sequential mode gear selection: Holds the selected gear, and the **M** indicator comes on.
- The selected gear position is shown in the instrument panel.

Gear Position Indicator



Sequential Mode Gear Selection Indicator

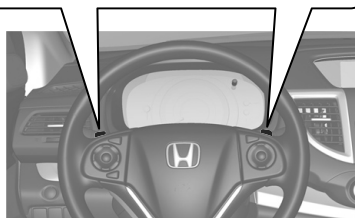
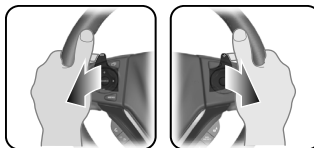

VSA OFF Button P. 479

- The vehicle stability assist (VSA) system helps stabilize the vehicle during cornering, and helps maintain traction while accelerating on loose or slippery road surfaces.
- VSA comes on automatically every time you start the engine.
- To turn VSA on or off, press and hold the button until you hear a beep.

Cruise Control* P. 431

- Cruise control allows you to maintain a set speed without keeping your foot on the accelerator pedal.
- To use cruise control, press the **MAIN** button. Select cruise control by pressing the **LIM** button, then press **RES/+** or **-/SET** when the vehicle speed is above 30 km/h (18 mph).

Adjustable Speed Limiter P. 435

- This system enables you to set a maximum speed that cannot be exceeded even if you are depressing the accelerator pedal.
- To use the adjustable speed limiter, press the **MAIN** button. Select the adjustable speed limiter by pressing the **LIM** button, then press the **-/SET** when your vehicle reaches the desired speed.
- The vehicle speed limit can be set from 30 km/h (18 mph) to 250 km/h (156 mph).

Deflation Warning System P. 484

- Detects a change in tyre conditions and overall dimensions due to decrease in tyre pressures.
- Deflation warning system is turned on automatically every time you start the engine.
- A calibration procedure must be performed when certain conditions arise.

Collision Mitigation Braking System (CMBS) OFF Button* P. 496

- When a possible collision is likely unavoidable, the CMBS can help you to reduce the vehicle speed and the severity of the collision.
- To turn the CMBS on or off, press and hold the button until you hear a beep.

Refueling P.522

Fuel recommendation: Premium unleaded petrol with a research octane number 95 or higher required

Fuel tank capacity: 58 L

- 1 Pull on the fuel fill door release handle under the lower left/right corner of the dashboard.



- 2 Turn the fuel fill cap slowly to remove the cap.

- 3 Place the cap in the holder on the fuel fill door.

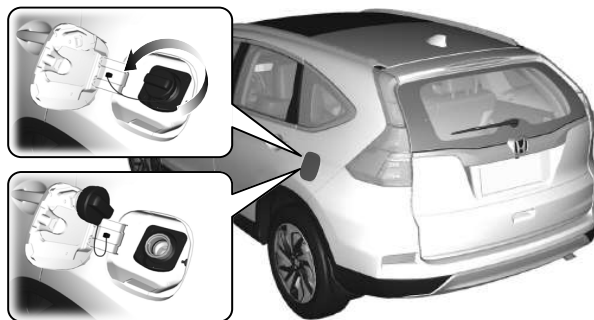

- 4 After refueling, screw the cap back on until it clicks at least once.

Diesel models

Refueling P. 523

Fuel recommendation: EN 590 standard diesel fuel*¹
Diesel fuel with sulfur less 50ppm only*²

Fuel tank capacity: 58 L

*1: Except Ukraine models

*2: Ukraine models

- 1** Pull on the fuel fill door release handle under the lower left/right corner of the dashboard.



- 2** After refueling, wait for about 10 seconds before removing the filler nozzle.

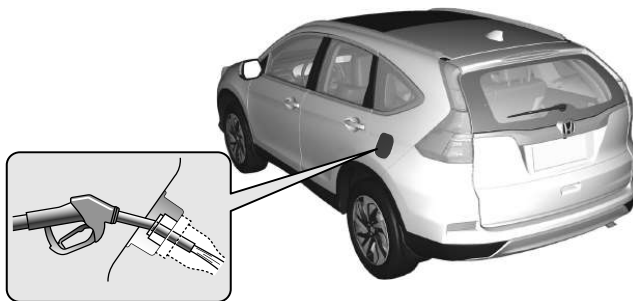

Maintenance [↔ P.527](#)

Under the Bonnet [↔ P.544](#)

- Check engine oil, engine coolant, and windscreen washer fluid. Add when necessary.
- Check brake fluid and clutch fluid*.
- Check the battery regularly.

- 1 Pull on the bonnet release handle under the corner of the dashboard.

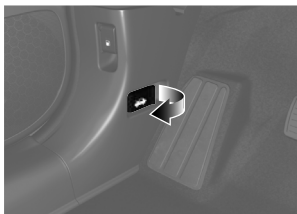

- 2 Locate the bonnet latch lever, pull the lever up, and lift up the bonnet.



- 3 When finished, close the bonnet and make sure it is firmly locked in place.

Wiper Blades [↔ P.576](#)

- Replace blades if they leave streaks across the windscreen.

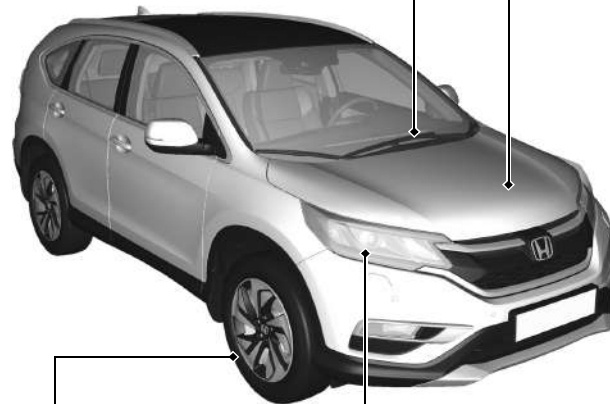

Tyres [↔ P.580](#)

- Inspect tyres and wheels regularly.
- Check tyre pressures regularly.
- Install winter tyres for winter driving.

Lights [↔ P.564](#)

- Inspect all lights regularly.

Handling the Unexpected P.601

Flat Tyre P.603

Models with a spare tyre

- Park in a safe location and replace the flat tyre with the compact spare tyre in the luggage area.

Models with tyre repair kit

- Park in a safe location and repair the flat tyre using the tyre repair kit.



Engine Won't Start P.621

- If the battery is dead, jump start using a booster battery.

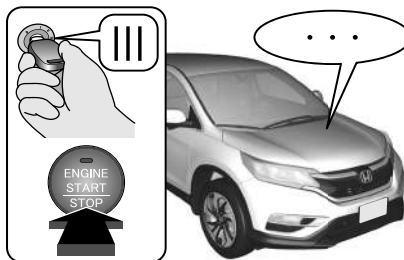

Overheating P.631

- Park in a safe location. If you do not see steam under the bonnet, open the bonnet, and let the engine cool down.



Indicators Come On P.633

- Identify the indicator and consult the owner's manual.

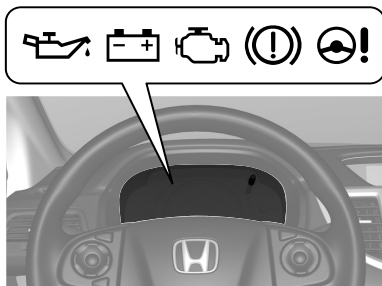

Blown Fuse P.639

- Check for a blown fuse if an electrical device does not operate.

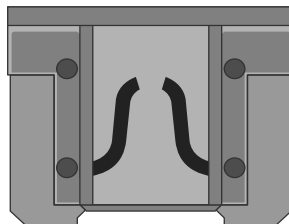

Emergency Towing P.647

- Call a professional towing service if you need to tow your vehicle.



What to Do If

Q The ignition switch does not turn from **0** to **I***1. Why?

- A**
- The steering wheel may be locked.
 - Try to turn the steering wheel left and right while turning the ignition key.
 - Move the steering wheel left and right while pressing the **ENGINE START/STOP** button at the same time.



Q The ignition switch does not turn from **I** to **0***1 and I cannot remove the key. Why?

- A** The gear position should be changed to **P**.



Q Why does the brake pedal pulsate slightly when applying the brakes?

- A** This can occur when the ABS activates, and does not indicate a problem. Apply firm, steady pressure on the brake pedal. Never pump the brake pedal.

*1: Models with the keyless access system have an **ENGINE START/STOP** button instead of an ignition switch.

Q The rear door cannot be opened from inside the vehicle. Why?

A Check if the childproof lock is in the lock position. If so, open the rear door with the outside door handle. To cancel this function, push the lever to the unlock position.

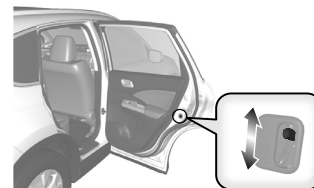

Q Why do the doors lock after I unlocked the doors using a remote transmitter?

A If you do not open a door within 30 seconds, the doors are relocked automatically for security.

Q Why does the beeper sound when I open the driver's door?

A The beeper sounds when:

- The exterior lights are left on.
- The power mode* is in ACCESSORY.
- Auto Idle Stop* is in operation.

Q Why does the beeper sound when I start driving?

A The beeper sounds when:

- Driver and/or front passenger are not wearing their seat belts.
- The parking brake lever is not fully released.

Q Why do I hear a screeching sound when I apply the brake pedal?

A The brake pads may need to be replaced. Have your vehicle inspected by a dealer.

Q **9-speed automatic transmission models**
Why does the gear position automatically change to **P** when I open the driver's door to check for parking space lines when reversing?

A

- Fasten the driver's seat belt.
- Close the driver's door and manually change the gear position.

▶ When opening the driver's door **➔ P. 414**

Q **Petrol models**
Is it possible to use unleaded petrol with a Research Octane Number (RON) of 91 or higher on this vehicle?

A Your vehicle is designed to operate on premium unleaded petrol with a research octane of 95 or higher. If this octane grade is unavailable, regular unleaded petrol with a research octane of 91 or higher may be used temporarily. The use of regular unleaded petrol can cause metallic knocking noises in the engine and will result in decreased engine performance. The long-term use of regular-grade petrol can lead to engine damage.

Event Data Recorders

Your vehicle is equipped with several devices commonly referred to as Event Data Recorders. They record various types of real time vehicle data such as SRS airbag deployment and SRS system components failure.

This data belongs to the vehicle owner and may not be accessed by anyone else except as legally required or with the permission of the vehicle owner.



However this data may be accessed by Honda, its authorised dealers and authorised repairers, employees, representatives and contractors only for the purpose of the technical diagnosis, research and development of the vehicle.

Service Diagnostic Recorders

Your vehicle is equipped with service-related devices that record information about powertrain performance and driving conditions. The data can be used to help technicians diagnose, repair and maintain the vehicle. This data may not be accessed by anyone else except as legally required or with the permission of the vehicle owner.

However this data may be accessed by Honda, its authorised dealers and authorised repairers, employees, representatives and contractors only for the purpose of the technical diagnosis, research and development of the vehicle.

As you read this manual, you will find Information that is preceded by a symbol **NOTICE**. This information is intended to help you avoid damage to your vehicle, other property, or the environment.

Symbols   on labels attached to your vehicle are to remind you to read this owner's manual for proper and safe operation of your vehicle.

 is colour-coded to indicate "danger" (red), "warning" (orange), or "caution" (amber).

A Few Words About Safety



Your safety, and the safety of others, is very important. And operating this vehicle safely is an important responsibility.

To help you make informed decisions about safety, we have provided operating procedures and other information on labels and in this manual. This information alerts you to potential hazards that could hurt you or others.

Of course, it is not practical or possible to warn you about all the hazards associated with operating or maintaining your vehicle. You must use your own good judgement.

You will find this important safety information in a variety of forms, including:

- **Safety Labels** - on the vehicle.
- **Safety Messages** - preceded by a safety alert symbol  and one of three signal words: **DANGER**, **WARNING**, or **CAUTION**. These signal words mean:

 DANGER	You WILL be KILLED or SERIOUSLY HURT if you don't follow instructions.
 WARNING	You CAN be KILLED or SERIOUSLY HURT if you don't follow instructions.
 CAUTION	You CAN be HURT if you don't follow instructions.

- **Safety Headings** - such as Important Safety Precautions.
- **Safety Section** - such as Safe Driving.
- **Instructions** - how to use this vehicle correctly and safely.

This entire book is filled with important safety information - please read it carefully.

Safe Driving

You can find many safety recommendations throughout this chapter, and throughout this manual.

For Safe Driving

Important Safety Precautions.....	34
Important Handling Information.....	36
Your Vehicle's Safety Features.....	37
Safety Checklist	38

Seat Belts

About Your Seat Belts.....	39
Fastening a Seat Belt	43
Seat Belt Inspection.....	47
Anchorage Points.....	48

Airbags

Airbag System Components.....	49
Types of Airbags	51
Front Airbags (SRS)	51
Side Airbags.....	56
Side Curtain Airbags.....	58
Airbag System Indicators.....	59
Airbag Care	61

Child Safety

Protecting Child Passengers	62
Safety of Infants and Small Children ..	65
Safety of Larger Children	78

Exhaust Gas Hazard

Carbon Monoxide Gas.....	81
--------------------------	----

Safety Labels

Label Locations	82
-----------------------	----

The following pages explain your vehicle's safety features and how to use them properly. The safety precautions below are ones that we consider to be among the most important.

Important Safety Precautions

■ Always wear your seat belt

A seat belt is your best protection in all types of collisions. Airbags are designed to supplement seat belts, not replace them. So even though your vehicle is equipped with airbags, make sure you and your passengers always wear your seat belts, and wear them properly.

■ Restrain all children

Children aged 12 and under should ride properly restrained in a back seat, not the front seat. Infants and small children should be restrained in a child restraint system. Larger children should use a booster seat and a lap/shoulder seat belt until they can use the belt properly without a booster seat.

■ Be aware of airbag hazards

While airbags can save lives, they can cause serious or fatal injuries to occupants who sit too close to them, or are not properly restrained. Infants, young children, and short adults are at the greatest risk. Be sure to follow all instructions and warnings in this manual.

■ Don't drink and drive

Alcohol and driving don't mix. Even one drink can reduce your ability to respond to changing conditions, and your reaction time gets worse with every additional drink. So don't drink and drive, and don't let your friends drink and drive, either.

ⓘ Important Safety Precautions

Some countries prohibit the use of mobile phones other than hands-free devices by the driver while driving.

■ **Pay appropriate attention to the task of driving safely**

Engaging in mobile phone conversation or other activities that keep you from paying close attention to the road, other vehicles, and pedestrians could lead to a crash. Remember, situations can change quickly, and only you can decide when it is safe to divert some attention away from driving.

■ **Control your speed**

Excessive speed is a major factor in crash injuries and deaths. Generally, the higher the speed, the greater the risk, but serious injuries can also occur at lower speeds. Never drive faster than is safe for current conditions, regardless of the maximum speed posted.

■ **Keep your vehicle in safe condition**

Having a tyre blowout or a mechanical failure can be extremely hazardous. To reduce the possibility of such problems, check your tyre pressures and condition frequently, and perform all regularly scheduled maintenance.

Important Handling Information

Your vehicle has higher ground clearance than a passenger vehicle designed for use only on pavement. Higher ground clearance has many advantages for off-road driving. It allows you to travel over bumps, obstacles, and rough terrain. It also provides good visibility so you can anticipate problems earlier.

These advantages come at some cost. Because your vehicle is taller and rides higher off the ground, it has a higher centre gravity making it more susceptible to tripping or roll over if you make abrupt turns. Utility vehicles have a significantly higher rollover rate than other types of vehicles. In a rollover crash, an unbelted person is significantly more likely to die than a person wearing a seat belt. As a reminder, make sure you and your passengers always wear seat belts.

Important Handling Information

For information on how to reduce the risk of rollover, read:

► **Precautions While Driving** P. 404

► **Off-road Guidelines** P. 395

Failure to operate your vehicle correctly might result in a crash or a rollover.

Your Vehicle's Safety Features

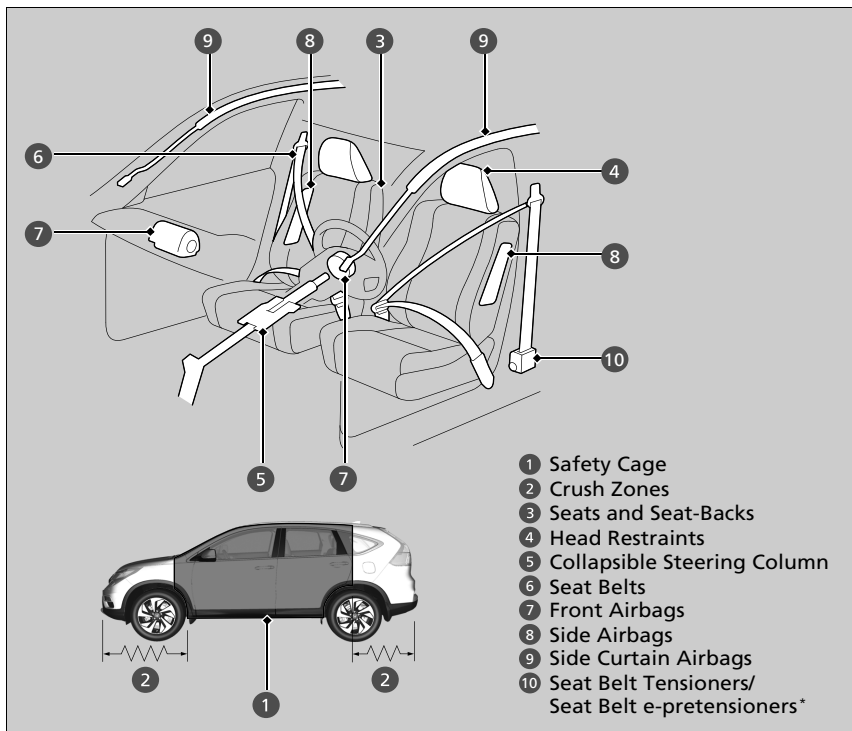

- 1 Safety Cage
- 2 Crush Zones
- 3 Seats and Seat-Backs
- 4 Head Restraints
- 5 Collapsible Steering Column
- 6 Seat Belts
- 7 Front Airbags
- 8 Side Airbags
- 9 Side Curtain Airbags
- 10 Seat Belt Tensioners/
Seat Belt e-pretensioners*

The following checklist will help you take an active role in protecting yourself and your passengers.

* Not available on all models

▣ Your Vehicle's Safety Features

Your vehicle is equipped with many features that work together to help to protect you and your passengers during a crash.

Some features do not require any action on your part. These include a strong steel framework that forms a safety cage around the passenger compartment, front and rear crush zones, a collapsible steering column, and tensioners that tighten the front seat belts in a sufficient crash.

However, you and your passengers cannot take full advantage of these features unless you remain seated in the correct position and always wear your seat belts. In fact, some safety features can contribute to injuries if they are not used properly.

Safety Checklist

For the safety of you and your passengers, make a habit of checking these items each time before you drive.

- Adjust your seat to a position suitable for driving. Be sure the front seats are adjusted as far to the rear as possible while allowing the driver to control the vehicle. Sitting too close to a front airbag can result in serious or fatal injury in a crash.
 - **Adjusting the Seats** P. 210
- Adjust head restraints to the proper position. Head restraints are most effective when the centre of the head restraint aligns with the centre of your head. Taller persons should adjust their head restraint to the highest position.
 - **Adjusting the Head Restraints** P. 213
- Always wear your seat belt, and make sure you wear it properly. Confirm that any passengers are properly belted as well.
 - **Fastening a Seat Belt** P. 43
- Protect children by using seat belts or child restraint system according to a child's age, height and weight.
 - **Child Safety** P. 62

➤ Safety Checklist

If the door and tailgate open indicator is on, a door and/or the tailgate is not completely closed. Close all doors and the tailgate tightly until the indicator goes off.

➤ **Door and Tailgate Open Indicator** P. 94

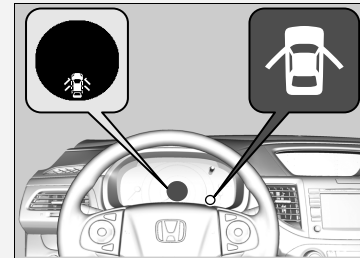

About Your Seat Belts

Seat belts are the single most effective safety device because they keep you connected to the vehicle so that you can take advantage of many built-in safety features. They also help to keep you from being thrown against the inside of the vehicle, against other passengers, or out of the vehicle. When worn properly, seat belts also keep your body properly positioned in a crash so that you can take full advantage of the additional protection provided by the airbags.

In addition, seat belts help to protect you in almost every type of crash, including:

- frontal impacts
- side impacts
- rear impacts
- rollovers

About Your Seat Belts

⚠ WARNING

Not wearing a seat belt properly increases the chance of serious injury or death in a crash, even though your vehicle has airbags.

Be sure you and your passengers always wear seat belts and wear them properly.

WARNING: Seat belts are designed to bear upon the bony structure of the body, and should be worn low across the front of the pelvis or the pelvis, chest and shoulders, as applicable; wearing the lap section of the belt across the abdominal area must be avoided.

WARNING: Seat belts should be adjusted as firmly as possible, consistent with comfort, to provide the protection for which they have been designed. A slack belt will greatly reduce the protection afforded to the wearer.

WARNING: Belts should not be worn with straps twisted.

WARNING: Each belt assembly must only be used by one occupant; it is dangerous to put a belt around a child being carried on the occupant's lap.

■ Lap/shoulder seat belts

All five seating positions are equipped with lap/shoulder seat belts with emergency locking retractors. In normal driving the retractor lets you move freely while keeping some tension on the belt. During a collision or sudden stop the retractor locks to restrain your body.

■ Proper use of seat belts

Follow these guidelines for proper use:

- All occupants should sit upright, well back in the seat, and remain in that position for the duration of the trip. Slouching and leaning reduce the effectiveness of the belt and can increase the chance of serious injury in a crash.
- Never place the shoulder part of a lap/shoulder seat belt under your arm or behind your back. This could cause very serious injuries in a crash.
- Two people should never use the same seat belt. If they do, they could be very seriously injured in a crash.
- Do not put any accessories on the seat belts. Devices intended to improve comfort or reposition the shoulder part of a seat belt can reduce the protective capability and increase the chance of serious injury in a crash.

▣ About Your Seat Belts

Seat belts cannot completely protect you in every crash. But in most cases, seat belts can reduce your risk of serious injury.

Most countries require you to wear seat belts. Take time to familiarize with the legal requirements of the countries in which you will drive.

The emergency locking retractor may lock if you lean forward too quickly. Slower movements will allow the belt to extend fully without locking.

Seat Belt Reminder

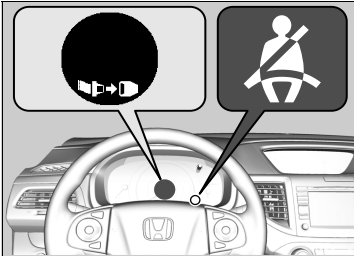

Front seats

Your vehicle monitors front seat belt use. If the ignition switch is turned to ON *1 before the driver's seat belt is fastened, the indicator will blink. If the driver does not fasten the belt, the indicator will remain on.

The beeper will also periodically sound and the indicator will blink while driving until the driver's seat belt is fastened.

Rear seats

Your vehicle also monitors rear seat belt use. A multi-information display notifies you if any of the rear seat belts are used.

The display appears when:

- A rear door is opened and closed.
- Any of the rear passengers latches or unlatches their seat belt.

The beeper sounds if any rear passenger's seat belt is unlatched while driving.

To see the display:

Press the  button.

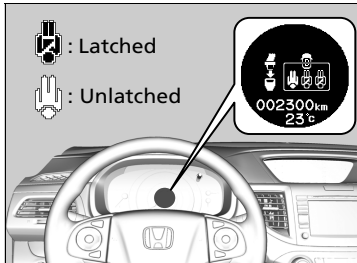

Seat Belt Reminder

The indicator will also come on if a front passenger does not fasten their seat belt within six seconds after the ignition switch is turned to ON *1.

When no one is sitting in the front passenger's seat, the indicator will not come on and the beeper will not sound.

If the indicator comes on or the beeper sounds with no front passenger, or with a passenger wearing the seat belt, something may be interfering with the occupant detection sensor. Such as:

- Heavy items are on the seat.
- A cushion is placed on the seat.
- The front passenger is not sitting properly.

If none of these conditions exist, have your vehicle checked by a dealer as soon as possible.

*1: Models with the keyless access system have an **ENGINE START/STOP** button instead of an ignition switch.

Automatic Seat Belt Tensioners

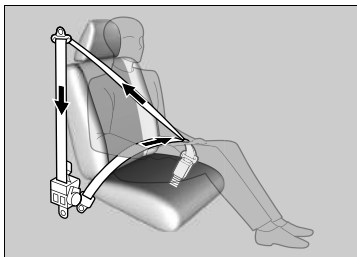

The front seats are equipped with automatic seat belt tensioners to enhance safety.

The tensioners automatically tighten the front seat belts during a moderate-to-severe frontal collision, sometimes even if the collision is not severe enough to inflate the front airbags.

Seat Belt e-pretensioners*

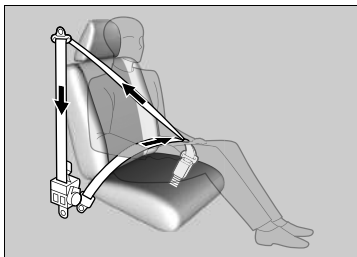

Are the motor-powered pretensioners that start to retract the front seat belts when the CMBS, brake assist system, or VSA system is in operation. They may also activate when you steer the vehicle hard, or the vehicle is impacted. After retracted, the seat belts are slackened to their original positions. As convenient features, the e-pretensioners slightly retract the seat belts when you latch the seat belt buckle, depress the brake pedal more aggressively than you normally do, or make a sharp turn, and fully retract when you release the seat belt buckle.

Automatic Seat Belt Tensioners

The seat belt tensioners can only operate once. If a tensioner is activated, the SRS indicator will come on. Have a dealer replace the tensioner and thoroughly inspect the seat belt system as it may not offer protection in a subsequent crash.

During a moderate-to-severe side impact, the tensioner on that side of the vehicle also activates.

Seat Belt e-pretensioners*

If only the e-pretensioners were activated, no components need to be replaced.

The e-pretensioners may not work if:

- Supplemental Restraint System Indicator is on.
- Vehicle Stability Assist (VSA) System Indicator is on.

Fastening a Seat Belt

After adjusting a front seat to the proper position, and while sitting upright and well back in the seat:

▶ **Adjusting the Seats** P. 210

Lap/Shoulder Belt

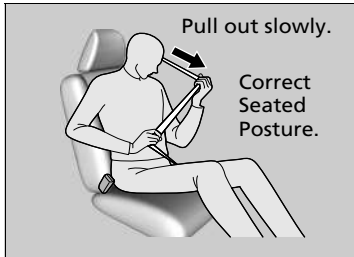

1. Pull the seat belt out slowly.

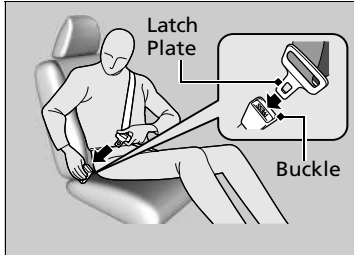

2. Insert the latch plate into the buckle, then tug on the belt to make sure the buckle is secure.

▶ Make sure that the belt is not twisted or caught on anything.

Models with adaptive cruise control

When you or the front passenger insert the their latch plate into the buckle, the front seat belt retract automatically.

Fastening a Seat Belt

No one should sit in a seat with an inoperative seat belt or one that does not appear to be working correctly. Using a seat belt that is not working properly may not protect the occupant in a crash. Have a dealer check the belt as soon as possible.

Never insert any foreign objects into the buckle or retractor mechanism.



3. Position the lap part of the belt as low as possible across your hips, then pull up on the shoulder part of the belt so the lap part fits snugly. This lets your strong pelvic bones take the force of a crash and reduces the chance of internal injuries.
4. If necessary, pull up on the belt again to remove any slack, then check that the belt rests across the centre of your chest and over your shoulder. This spreads the forces of a crash over the strongest bones in your upper body.

Fastening a Seat Belt

WARNING

Improperly positioning the seat belts can cause serious injury or death in a crash.

Make sure all seat belts are properly positioned before driving.

To release the belt, push the red **PRESS** button then guide the belt by hand until it has retracted completely. When exiting the vehicle, be sure the belt is out of the way and will not get caught by closing the door.

Adjusting the Shoulder Anchor

The shoulder anchor height can be adjusted to four levels. If the belt contacts your neck, lower the height one level at a time.

After an adjustment, make sure that the shoulder anchor position is secure.

Adjusting the Shoulder Anchor

The front seats have adjustable shoulder anchors to accommodate taller and shorter occupants.

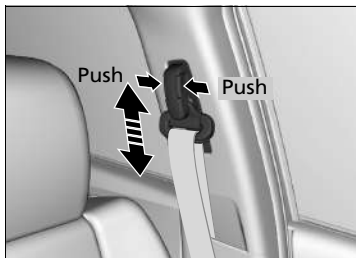

1. Move the anchor up and down while holding the release buttons.
2. Position the anchor so that the belt rests across the centre of your chest and over your shoulder.

Seat Belt with Detachable Anchor

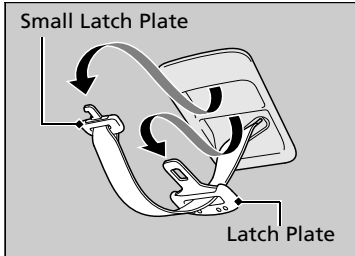

1. Pull out the seat belt's small latch plate and the latch plate from each holding slot in the ceiling.

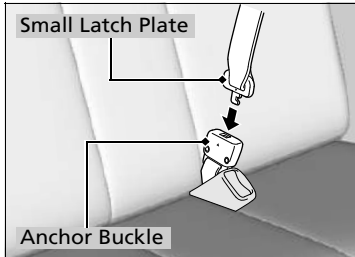

2. Line up the triangle marks on the small latch plate and anchor buckle. Make sure the seat belt is not twisted. Attach the belt to the anchor buckle.

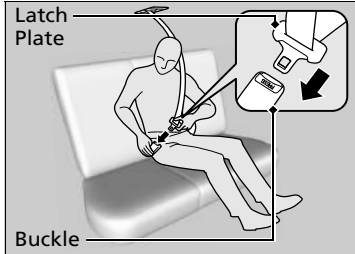

3. Insert the latch plate into the buckle. Properly fasten the seat belt the same way you fasten the lap/shoulder seat belt.

Seat Belt with Detachable Anchor

⚠ WARNING

Using the seat belt with the detachable anchor unlatched increases the chance of serious injury or death in a crash.

Before using the seat belt, make sure the detachable anchor is correctly latched.

To unlatch the detachable anchor, insert the latch plate into the slot on the side of the anchor buckle.

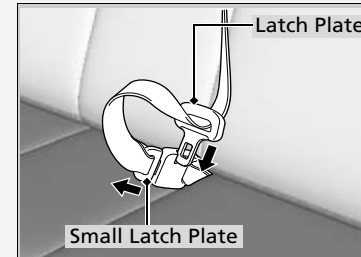

Continued

■ Advice for Pregnant Women

If you are pregnant, the best way to protect yourself and your unborn child when driving or riding in a vehicle is to always wear a seat belt and keep the lap part of the belt as low as possible across the hips.

Wear the shoulder belt across the chest avoiding the abdomen.



Wear the lap part of the belt as low as possible across the hips.

▣ Advice for Pregnant Women

Each time you have a checkup, ask your doctor if it is okay for you to drive.

To reduce the risk of injuries to both you and your unborn child that can be caused by an inflating front airbag:

- When driving, sit upright and adjust the seat as far back as possible while allowing full control of the vehicle.
- When sitting in the front passenger's seat, adjust the seat as far back as possible.

Seat Belt Inspection

Regularly check the condition of your seat belts as follows:

- Pull each belt out fully, and look for frays, cuts, burns, and wear.
- Check that the latches work smoothly and the belts retract easily.
 - ▶ If a belt does not retract easily, cleaning the belt may correct the problem. Only use a mild soap and warm water. Do not use bleach or cleaning solvents. Make sure the belt is completely dry before allowing it to retract.

Any belt that is not in good condition or working properly will not provide proper protection and should be replaced as soon as possible.

A belt that has been worn during a crash may not provide the same level of protection in a subsequent crash. Have your seat belts inspected by a dealer after any collision.

▶▶ Seat Belt Inspection

WARNING

Not checking or maintaining seat belts can result in serious injury or death if the seat belts do not work properly when needed.

Check your seat belts regularly and have any problem corrected as soon as possible.

WARNING: No modifications or additions should be made by the user which will either prevent the seat belt adjusting devices from operating to remove slack, or prevent the seat belt assembly from being adjusted to remove slack.

WARNING: It is essential to replace the entire assembly after it has been worn in a severe impact even if damage to the assembly is not obvious.

WARNING: Care should be taken to avoid contamination of the webbing with polishes, oils and chemicals, and particularly battery acid. Cleaning may safely be carried out using mild soap and water. The belt should be replaced if webbing becomes frayed, contaminated or damaged.

Anchorage Points

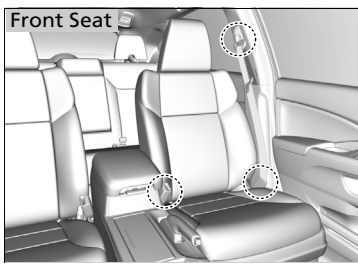

When replacing the seat belts, use the anchorage points shown in the images. The front seat has a lap/shoulder belt.

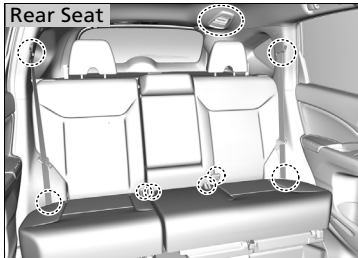

The rear seat has three lap/shoulder belts.

Airbag System Components

The front, front side, and side curtain airbags are deployed according to the direction and severity of impact. The airbag system includes:

- Two SRS (Supplemental Restraint System) front airbags. The driver's airbag is stored in the centre of the steering wheel; the front passenger's airbag is stored in the dashboard. Both are marked **SRS AIRBAG**.
- Two side airbags, one for the driver and one for a front passenger. The airbags are stored in the outer edges of the seat-backs. Both are marked **SIDE AIRBAG**.
- Two side curtain airbags, one for each side of the vehicle. The airbags are stored in the ceiling, above the side windows. The front and rear pillars are marked **SIDE CURTAIN AIRBAG**.

- An electronic control unit that continually monitors and records information about the sensors, the airbag activators, the seat belt tensioners, and driver and front passenger seat belt use when the ignition switch is in ON ^{*1}.
- Automatic front seat belt tensioners.
 - Models with CMBS**
 - The front seat belt tensioners also include the e-pretensioners.
 - Impact sensors that can detect a moderate-to-severe front or side collision.
- An indicator on the instrument panel that alerts you to a possible problem with your airbag system or seat belt tensioners.
- An indicator on the dashboard that alerts you that the passenger's front airbag has been turned off.
- Safing Sensor

*1: Models with the keyless access system have an **ENGINE START/STOP** button instead of an ignition switch.

■ Important facts about your airbags

Airbags can pose serious hazards. To do their job, airbags must inflate with tremendous force. So, while airbags help to save lives, they can cause burns, bruises, and other minor injuries, sometimes even fatal ones if occupants are not wearing their seat belts properly and sitting correctly.

What you should do: Always wear your seat belt properly, and sit upright and as far back from the steering wheel as possible while allowing full control of the vehicle. A front passenger should move their seat as far back from the dashboard as possible.

Remember, however, that no safety system can prevent all injuries or deaths that can occur in a severe crash, even when seat belts are properly worn and the airbags deploy.

Do not place hard or sharp objects between yourself and a front airbag.

Carrying hard or sharp objects on your lap, or driving with a pipe or other sharp object in your mouth, can result in injuries if your front airbag inflates.

Do not attach or place objects on the front airbag covers. Objects on the covers marked **SRS AIRBAG** could interfere with the proper operation of the airbags or be propelled inside the vehicle and hurt someone if the airbags inflate.

▣ Important facts about your airbags

Do not attempt to deactivate your airbags. Together, airbags and seat belts provide the best protection.

When driving, keep hands and arms out of the deployment path of the front airbag by holding each side of the steering wheel. Do not cross an arm over the airbag cover.

Types of Airbags

Your vehicle is equipped with three types of airbags:

- **Front airbags:** Airbags in front of the driver's and front passenger's seats.
- **Side airbags:** Airbags in the driver's and front passenger's seat-backs.
- **Side curtain airbags:** Airbags above the side windows.

Each is discussed in the following pages.

Front Airbags (SRS)

The front SRS airbags inflate in a moderate-to-severe frontal collision to help to protect the head and chest of the driver and/or front passenger.

SRS (Supplemental Restraint System) indicates that the airbags are designed to supplement seat belts, not replace them. Seat belts are the occupant's primary restraint system.

Housing Locations

The front airbags are housed in the centre of the steering wheel for the driver, and in the dashboard for the front passenger. Both airbags are marked **SRS AIRBAG**.

Types of Airbags

The airbags can inflate whenever the ignition switch is in ON **[II]***1.

After an airbag inflates in a crash, you may see a small amount of smoke. This is from the combustion process of the inflator material and is not harmful. People with respiratory problems may experience some temporary discomfort. If this occurs, get out of the vehicle as soon as it is safe to do so.

*1: Models with the keyless access system have an **ENGINE START/STOP** button instead of an ignition switch.

Front Airbags (SRS)

During a frontal crash severe enough to cause one or both front airbags to deploy, the airbags can inflate at different rates, depending on the severity of the crash, whether or not the seat belts are latched, and/or other factors. Frontal airbags are designed to supplement the seat belts to help to reduce the likelihood of head and chest injuries in frontal crashes.

■ Operation

Front airbags are designed to inflate during moderate-to-severe frontal collisions. When the vehicle decelerates suddenly, the sensors send information to the control unit which signals one or both front airbags to inflate.

A frontal collision can be either head-on or angled between two vehicles, or when a vehicle crashes into a stationary object, such as a concrete wall.

■ How the Front Airbags Work

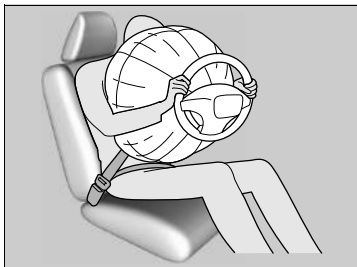

While your seat belt restrains your torso, the front airbag provides supplemental protection for your head and chest.

The front airbags deflate immediately so that they won't interfere with the driver's visibility or the ability to steer or operate other controls.

The total time for inflation and deflation is so fast that most occupants are not aware that the airbags deployed until they see them lying in front of them.

▣ How the Front Airbags Work

Although the driver's and front passenger's airbags normally inflate within a split second of each other, it is possible for only one airbag to deploy. This can happen if the severity of a collision is at the margin, or threshold that determines whether or not the airbags will deploy. In such cases, the seat belt will provide sufficient protection, and the supplemental protection offered by the airbag would be minimal.

■ When front airbags should not deploy

Minor frontal crashes: Front airbags were designed to supplement seat belts and help to save lives, not to prevent minor scrapes, or even broken bones that might occur during a less than moderate-to-severe frontal crash.

Side impacts: Front airbags can provide protection when a sudden deceleration causes a driver or front passenger to move towards the front of the vehicle. Side airbags and side curtain airbags have been specifically designed to help to reduce the severity of injuries that can occur during a moderate-to-severe side impact which can cause the driver or passenger to move towards the side of the vehicle.

Rear impacts: Head restraints and seat belts are your best protection during a rear impact. Front airbags cannot provide any significant protection and are not designed to deploy in such collisions.

Rollovers: Seat belts, side airbags and side curtain airbags offer the best protection in a rollover. Because front airbags could provide little if any protection, they are not designed to deploy during a rollover.

■ When front airbags deploy with little or no visible damage

Because the airbag system senses sudden deceleration, a strong impact to the vehicle framework or suspension might cause one or more of the airbags to deploy. Examples include running into a curb, the edge of a hole, or other low fixed object that causes a sudden deceleration in the vehicle chassis. Since the impact is underneath the vehicle, damage may not be readily apparent.

■ When front airbags may not deploy, even though exterior damage appears severe

Since crushable body parts absorb crash energy during an impact, the amount of visible damage does not always indicate proper airbag operation. In fact, some collisions can result in severe damage but no airbag deployment because the airbags would not have been needed or would not have provided protection even if they had deployed.

Passenger Front Airbag Off System

If it is unavoidable to install a rear-facing child restraint system in the front passenger seat, you must manually deactivate the passenger front airbag system, using the ignition key.

Passenger front airbag ON/OFF switch

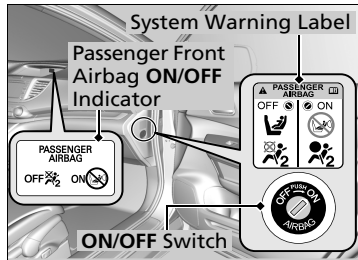

When the passenger front airbag **ON/OFF** switch is in:

OFF: The passenger front airbag is deactivated. The passenger front airbag does not inflate during a severe frontal crash that inflates driver's front airbag. The passenger front airbag off indicator stays on as a reminder.

ON: The passenger front airbag is activated. The passenger front airbag on indicator is comes on and remain on for about 60 seconds.

To deactivate the passenger front airbag system

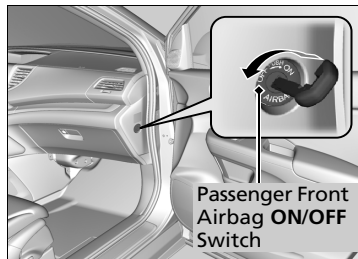

1. Set the parking brake, and turn the ignition switch to LOCK **0***1. Remove the key.
2. Open the front passenger's door.
3. Insert the ignition key to the passenger front airbag **ON/OFF** switch.
 - ▶ The switch is located at the side panel of the front passenger side instrument panel.
4. Turn the key to **OFF**, and remove it from the switch.

*1: Models with the keyless access system have an **ENGINE START/STOP** button instead of an ignition switch.

Passenger Front Airbag Off System

WARNING

The passenger front airbag system must be turned off, if it is not avoidable to put a rear-facing child restraint system in the front passenger seat.

If the front passenger airbag inflates, it can hit the rear-facing child restraint system with enough force to kill or cause a very serious injury to the infant.

WARNING

Make sure to turn on the passenger front airbag system when a rear-facing child restraint system is not used on the front passenger seat.

Leaving the passenger front airbag system deactivated can result in serious injury or death in a crash.

■ Passenger front airbag off indicator

When the passenger front airbag system is activated, the ON indicator comes on for one minute, and goes off.

When the passenger front airbag system is deactivated, the OFF indicator comes on and stays on.

■ Passenger front airbag off system label

The label is located at the side panel of the front passenger side instrument panel.

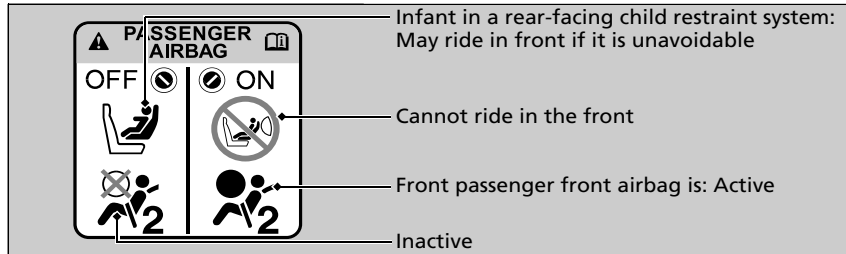

▶▶ Passenger Front Airbag Off Switch

NOTICE

- Use your vehicle's ignition key to turn the passenger front airbag **ON/OFF** switch. If you use a different key, the switch can be damaged, or the passenger front airbag system may not work properly.
- Do not close the door or apply excessive load on the ignition key while the key is in the passenger front airbag **ON/OFF** switch. The switch or the key can be damaged.

We strongly recommend that you must not install a rear-facing child restraint system in the front passenger seat.

▶▶ Protecting Infants P. 65

It is your responsibility to change the setting of the passenger front airbag system to **OFF** when you put a rear-facing child restraint system on the front passenger seat.

When a rear-facing child restraint system is not in use in the front passenger seat, turn the system back on.

Side Airbags

The side airbags help to protect the torso and pelvis of the driver or a front passenger during a moderate-to-severe side impact.

The side airbags are especially hazardous if a child is sitting in the front seat.

Housing Locations

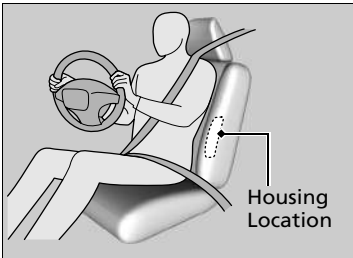

The side airbags are housed in the outside edge of the driver's and passenger's seat-backs.

Both are marked **SIDE AIRBAG**.

Side Airbags

Do not let the front passenger lean sideways with their head in the deployment path of the side airbag. An inflating side airbag can strike with strong force and seriously injure the passenger.

Do not attach accessories on or near the side airbags. They can interfere with the proper operation of the airbags, or hurt someone if an airbag inflates.

If the impact is on the passenger side, the airbag deploys even if there is no passenger in the passenger seat.

■ Operation

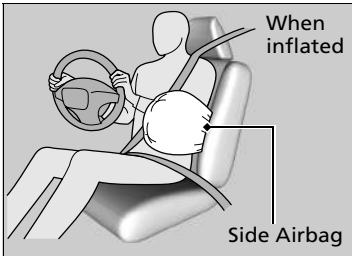

When the sensors detect a moderate-to-severe side impact, the control unit signals the side airbag on the impact side to immediately inflate.

■ When a side airbag deploys with little or no visible damage

Because the airbag system senses sudden acceleration, a strong impact to the side of the vehicle's framework can cause a side airbag to deploy. In such cases, there may be little or no damage, but the side impact sensors detected a severe enough impact to deploy the airbag.

■ When a side airbag may not deploy, even though visible damage appears severe

It is possible for a side airbag to not deploy during an impact that results in apparently severe damage. This can occur when the point of impact was towards the far front or rear of the vehicle, or when the vehicle's crushable body parts absorbed most of the crash energy. In either case, the side airbag would not have been needed nor provided protection even if it had deployed.

⊠ Side Airbags

Do not cover or replace the front seat-back covers without consulting a dealer. Improperly replacing or covering front seat-back covers can prevent your side airbags from properly deploying during a side impact.

Do not let the front passenger lean sideways with their head in the deployment path of the side airbag. An inflating side airbag can strike with strong force and seriously injure the passenger.

Side Curtain Airbags

The side curtain airbags help to protect the heads of the driver and passengers in outer seating positions during a moderate-to-severe side impact.

Housing Locations

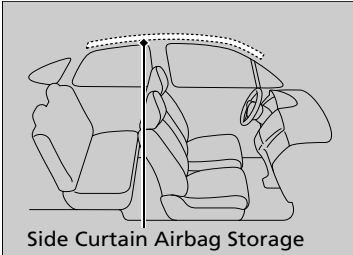

The side curtain airbags are located in the ceiling above the side windows on both sides of the vehicle.

Operation

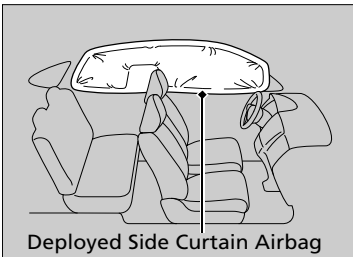

The side curtain airbag is designed to deploy in a moderate-to-severe side impact.

When side curtain airbags deploy in a frontal collision

One or both side curtain airbags may inflate in a moderate-to-severe angled frontal collision.

In this case, the side curtain airbags will deploy slightly after the front airbags.

Side Curtain Airbags

The side curtain airbags are most effective when an occupant is wearing their seat belt properly and sitting upright, well back in their seat.

Do not attach any objects to the side windows or roof pillars as they can interfere with the proper operation of the side curtain airbags.

Do not put a coat hanger or hard objects on a coat hook. This could result in injuries if your side curtain airbag inflates.

Airbag System Indicators

If a problem occurs in the airbag system, the SRS indicator comes on and a message appears on the multi-information display.

Supplemental Restraint System (SRS) Indicator

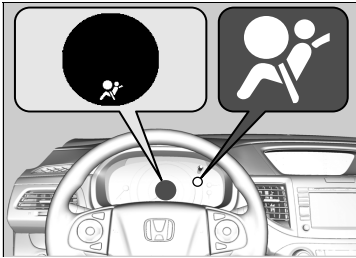

■ When the ignition switch is turned to ON *1

The indicator comes on for a few seconds, then goes off. This tells you the system is working properly.

If the indicator comes on at any other time, or does not come on at all, have the system checked by a dealer as soon as possible. If you don't, your airbags and seat belt tensioners may not work properly when they are needed.

*1: Models with the keyless access system have an **ENGINE START/STOP** button instead of an ignition switch.

Supplemental Restraint System (SRS) Indicator

WARNING

Ignoring the SRS indicator can result in serious injury or death if the airbag systems or tensioners do not work properly.

Have your vehicle checked by a dealer as soon as possible if the SRS indicator alerts you to a possible problem.

WARNING

Remove the rear-facing child restraint system immediately from the front passenger seat if the SRS indicator comes on. Even if the passenger front airbag has been deactivated, do not ignore the SRS indicator.

The SRS system may have a fault which could cause the passenger front airbag to be activated, causing serious injury or death.

■ Passenger Front Airbag Off Indicator

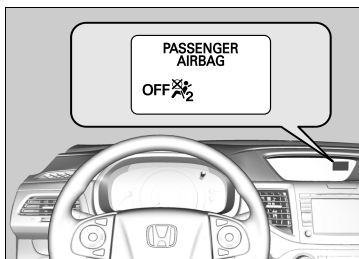

■ When the passenger airbag off indicator comes on

The indicator stays on while the passenger's front airbag system is deactivated.

When a rear-facing child restraint system is not in use in the front passenger seat, manually turn the system back on. The indicator should go off.

Airbag Care

You do not need to, and should not, perform any maintenance on or replace any airbag system components yourself. However, you should have your vehicle inspected by a dealer in the following situations:

■ When the airbags have deployed

If an airbag has inflated, the control unit and other related parts must be replaced. Similarly, once an automatic seat belt tensioner has been activated, it must be replaced.

■ When the vehicle has been in a moderate-to-severe collision

Even if the airbags did not inflate, have your dealer inspect the following: front seat belt tensioners, and each seat belt that was worn during the crash.

✘ Airbag Care

The removal of airbag components from the vehicle is prohibited.

In case of malfunction, or shutdown, or after the airbag inflation/seat belt tensioner operation, ask a qualified personnel for handling.

We recommend against the use of salvaged airbag system components, including the airbag, tensioners, sensors, and control unit.

Protecting Child Passengers

Each year, many children are injured or killed in vehicle crashes because they are either unrestrained or not properly restrained. In fact, vehicle accidents are the number one cause of death of children aged 12 and under.

To reduce the number of child deaths and injuries, infants and children should be properly restrained when they ride in a vehicle.

Protecting Child Passengers

WARNING

Children who are unrestrained or improperly restrained can be seriously injured or killed in a crash.

Any child too small for a seat belt should be properly restrained in an approved child restraint system. A larger child should be properly restrained with a seat belt, using a booster seat if necessary.

In many countries, the law requires all children aged 12 and under, and whose height are shorter than 150 cm (60 inches) be properly restrained in a rear seat.

In many countries, it is required to use an officially approved and suitable child restraint system for transporting a child on any passenger seat. Check your local legal requirement.

European models

Child restraint systems must meet the UN-ECE R44 or the regulations of the subject countries.

 **Selecting a Child Restraint System** P. 68

Except European models

We recommend that child restraint systems meet the UN-ECE R44 or the regulations of the subject countries.

Children should sit properly restrained in a rear seat. This is because:

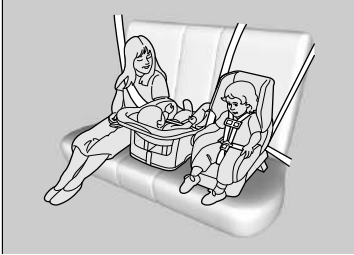

- An inflating front or side airbag can injure or kill a child sitting in the front seat.
- A child in the front seat is more likely to interfere with the driver's ability to safely control the vehicle.
- Statistics show that children of all sizes and ages are safer when they are properly restrained in a rear seat.

- Any child who is too small to wear a seat belt must be properly restrained in an approved child restraint system that is properly secured to the vehicle using the lap belt portion of the lap/shoulder belt.
- Never hold a child on your lap because it is impossible to protect them in the event of a collision.
- Never put a seat belt over yourself and a child. During a crash, the belt would likely press deep into the child and cause serious or fatal injuries.
- Never let two children use the same seat belt. Both children could be very seriously injured in a crash.
- Do not allow children to operate the doors, windows or seat adjustments.
- Do not leave children in the vehicle unattended, especially in hot weather when the inside of the vehicle can get hot enough to kill them. They could also activate vehicle controls causing it to move unexpectedly.

► Protecting Child Passengers

Front Passenger's Sunvisor

⚠ WARNING

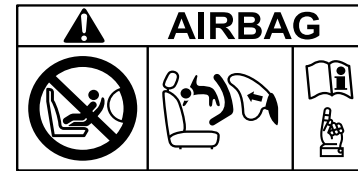

NEVER use a rearward facing child restraint on a seat protected by an **ACTIVE AIRBAG** in front of it, **DEATH** or **SERIOUS INJURY** to the **CHILD** can occur.

WARNING: Use the power window lock button to prevent children from opening the windows. Using this feature will prevent children from playing with the windows, which could expose them to hazards or distract the driver.

► **Opening/Closing the Power Windows** P. 180

WARNING: Always take the ignition key with you whenever you leave the vehicle alone (with other occupants).

Safety of Infants and Small Children

Protecting Infants

An infant must be properly restrained in a rear-facing, reclining child restraint system until the infant reaches the restraint system manufacturer's weight or height limit for the seat, and the infant is at least one year old.

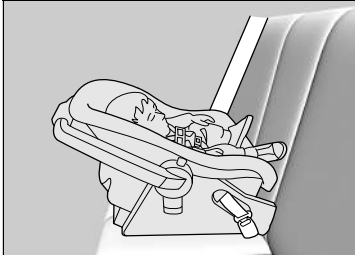

Positioning a rear-facing child restraint system

Child restraint system must be placed and secured in a rear seating position.

Protecting Infants

⚠ WARNING

Placing a rear-facing child restraint system in the front seat can result in serious injury or death if the passenger's front airbag inflates.

Always place a rear-facing child restraint system in the back seat, not the front.

As required by UN-ECE R94 Regulation:

⚠ WARNING

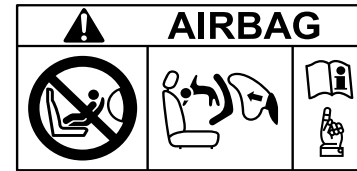

NEVER use a rearward facing child restraint on a seat protected by an ACTIVE AIRBAG in front of it, DEATH or SERIOUS INJURY to the CHILD can occur.

When properly installed, a rear-facing child restraint system may prevent the driver or a front passenger from moving their seat all the way back, or from locking their seat-back in the desired position.

► Protecting Infants

If the passenger's front airbag inflates, it can hit the rear-facing child restraint system with great force, which can dislodge or strike the system, and seriously injure the child.

Rear-facing child restraint systems should never be installed in a front facing position.

Always refer to the child restraint system manufacturer's instructions before installation.

If it is absolutely unavoidable to install a rear-facing child restraint system in the front passenger seat, manually turn off the passenger front airbag system.

► **Passenger Front Airbag Off System** P. 54

■ Protecting Smaller Children

If a child is at least one year old and within the weight range indicated by the child restraint system manufacturer, the child should be properly restrained in a firmly secured front facing child restraint system.



■ Front facing child restraint system placement

We strongly recommend placing a front facing child restraint system in a rear seating position.

Placing a front facing child restraint system in the front seat can be hazardous. A rear seat is the safest place for a child.

▣ Protecting Smaller Children

⚠ WARNING

Placing a front facing child restraint system in the front seat can result in serious injury or death if the front airbag inflates.

If you must place a front facing child restraint system in front, move the vehicle seat as far back as possible, and properly restrain the child.

Educate yourself about the laws and regulations regarding child restraint system use where you are driving, and follow the child restraint system manufacturer's instructions.

Many experts recommend use of a rear-facing child restraint system for a child up to two years old if the child's height and weight are appropriate for a rear-facing child restraint system.

■ Selecting a Child Restraint System

Some child restraint systems are lower anchorage compatible. Some have a rigid-type connector while others have a flexible-type connector. Both are equally easy to use. Some existing and previously owned child restraint systems can only be installed using the seat belt. Whichever type you choose, follow the child restraint system manufacturer's use and care instructions as well as the instructions in this manual. Proper installation is key to maximizing your child's safety.

The flexible type may not be available in your country.

In seating positions not equipped with lower anchorages, install a child restraint system using the seat belt and a top tether for added security. This is because all child restraint systems must be secured with a lap belt or the lap part of a lap/shoulder belt when not using the lower anchorage system. In addition, the child restraint system manufacturer may advise that a seat belt be used to attach an ISO FIX restraint system once a child reaches a specified weight. Please read the child restraint system owner's manual for proper installation instructions.

■ Important consideration when selecting a child restraint system

Make sure the child restraint system meets the following three requirements:

- The child restraint system is the correct type and size for the child.
- The child restraint system is the correct type for the seating position.
- Child restraint system is compliant with safety standard. We recommend the child restraint system with the UN-ECE R44 or the regulations of the subject countries. Look for the approval mark on the system and the manufacturer's statement of compliance on the box.

☒ Selecting a Child Restraint System

Installation of a lower anchorage*-compatible child restraint system is simple.

Lower anchorage-compatible child restraint systems have been developed to simplify the installation process and reduce the likelihood of injuries caused by incorrect installation.

The Recommended Child Restraint System for EU Countries

Various types of child restraint systems are available. Not all types are suitable for your vehicle. Please refer to the table below to select which category of child restraint system can be used on each seating position.

Mass group		Seating position			
		Front passenger		Rear passenger*3	
		Passenger front airbag ON/OFF switch position		Rear outboard	Rear centre
OFF	ON				
group 0	Up to 10 kg	U*1, *2	X	U	X
group 0+	Up to 13 kg	U*1, *2	X	IL (Honda BABY-SAFE ISOFIX, Honda iZi Kid X3 ISOFIX) or U	IL (Honda BABY-SAFE ISOFIX, Honda iZi Kid X3 ISOFIX) or Honda BABY-SAFE
group I	9 kg to 18 kg	U*1, *2	UF*1	IUF (Size class A, B1, B) or IL (Honda iZi Kid X3 ISOFIX) or U	IUF (Size class A, B1, B) or IL (Honda iZi Kid X3 ISOFIX) or Honda Eclipse
group II	15 kg to 25 kg	U*1, *2	UF*1	L (Honda KID FIX) or U	L (Honda KID FIX)
group III	22 kg to 36 kg	U*1, *2	UF*1	L (Honda KID FIX) or U	L (Honda KID FIX)

-
- IL: Suitable for particular ISO FIX child restraint system (CRS) given in this list.
 - IUF: Suitable for front facing ISOFIX child restraints system of universal category approved for use in this mass group. For Group I, the front facing genuine Honda ISO FIX child restraint system is available from a dealer.
 - L: Suitable for particular child restraint systems given in this table. These restraints may be of the “specific vehicle,” “restricted,” or “semi-universal” category.
 - U: Suitable for “universal” category restraints approved for use in this mass group.
 - UF: Suitable for front facing “universal” category restraints approved for use in this mass group.
 - X: Seat position not suitable for children in this mass group.
 - *1: Move the front seat to its rearmost position.
 - *2: Adjust seat-back angle to the most upright position, when installed in rear-facing.
 - *3: When the ISOFIX child restraint system is installed on the centre seat, wearing L side seat belt is impossible.
When the ISOFIX child restraint system is installed on L side seat, wearing seat belt of the centre seat is impossible.
-

A size class is specified for some child restraint systems. Make sure to check the size class as indicated on the manufacturer’s instructions, package, and labels of the child restraint.
The particular child restraints in the table are Honda Genuine Parts. They are available from your dealer.
For a correct installation, please refer to the Child Restraint Instruction Manual.

Installing a Lower Anchorage-Compatible Child Restraint System

A lower anchorage-compatible child restraint system can be installed in rear seats. A child restraint system is attached to the lower anchorages with either the rigid or flexible type of connectors.

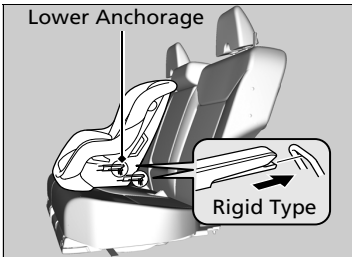
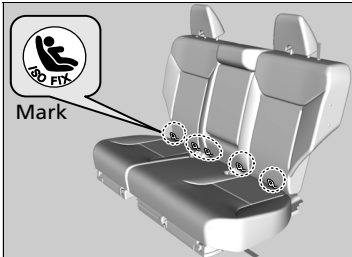

1. Locate the lower anchorages under the marks.

2. Place the child restraint system on the vehicle seat then attach the child restraint system to the lower anchorages according to the instructions that came with the child restraint system.

- When installing the child restraint system, make sure that the lower anchorages are not obstructed by the seat belt or any other object.

Installing a Lower Anchorage-Compatible Child Restraint System

Some child restraint systems come with optional guide-cups, which avoid possible damage to the seat surface. Follow the manufacturer's instructions when using the guide-cups, and attach them to the lower anchorages as shown in the image.

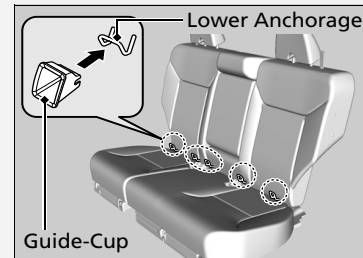

Continued

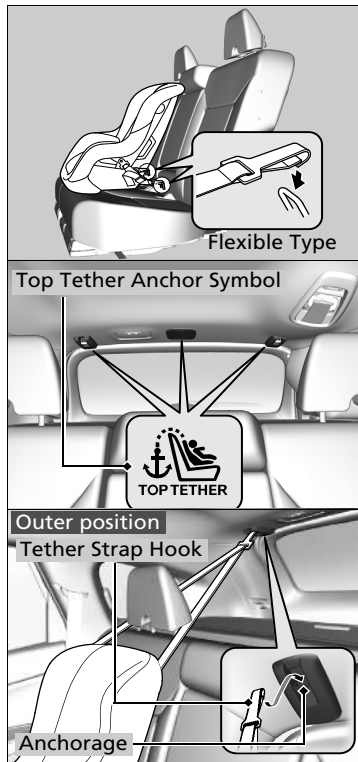

Outer positions

3. Pull up the head restraint and push rearward until it latches, then route the tether strap over the seat-back through the outsides of the head restraint legs, and secure the tether strap hook onto the anchorage.
4. Tighten the tether strap as instructed by the child restraint system manufacturer.
5. Make sure the child restraint system is firmly secured by rocking it forward and back and side to side; little movement should be felt.

► Installing a Lower Anchorage-Compatible Child Restraint System

For your child's safety, when using a child restraint system installed using the lower anchorage system, make sure that the child restraint system is properly secured to the vehicle. A child restraint system that is not properly secured will not adequately protect a child in a crash and may cause injury to the child or other vehicle occupants.

The flexible type may not be available in your country.

WARNING: Never use a hook that does not come with a Top Tether anchor symbol when securing an installed child restraint system.

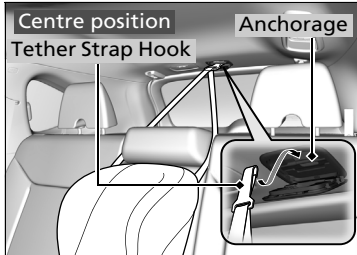
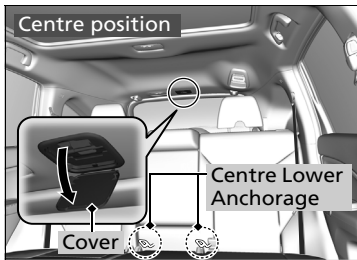

Centre position

3. Lower the head restraint to its lowest position.
4. Open the anchorage cover.

5. Route the tether strap over the seat-back. Make sure the strap is not twisted.
6. Secure the tether strap hook onto the anchorage.

All positions

7. Tighten the tether strap as instructed by the child restraint system manufacturer.
8. Make sure the child restraint system is firmly secured by rocking it forward and back and side to side; little movement should be felt.
9. Make sure any unused seat belt that a child can reach is buckled, the lockable retractor is activated, and the belt is fully retracted and locked.

■ Installing a Child Restraint System with a Lap/Shoulder Seat Belt

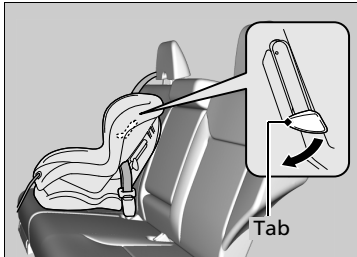
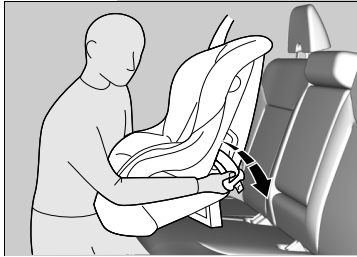

1. Place the child restraint system on the vehicle seat.
2. Route the seat belt through the child restraint system according to the child restraint system manufacturer's instructions, and insert the latch plate into the buckle.
 - Insert the latch plate fully until it clicks.
3. Push down the tab. Route the shoulder part of the belt into the slit at the side of the restraint.
4. Grab the shoulder part of the belt near the buckle, and pull up to remove any slack from the lap part of the belt.
 - When doing this, place your weight on child restraint system and push it into the vehicle seat.
5. Position the belt properly and push up the tab. Make sure the belt is not twisted.
 - When pushing up the tab, pull up the upper shoulder part of the belt to remove any slack from the belt.

⊠ Installing a Child Restraint System with a Lap/Shoulder Seat Belt

A child restraint system that is not properly secured will not adequately protect a child in a crash and may cause injury to the child or other vehicle occupants.

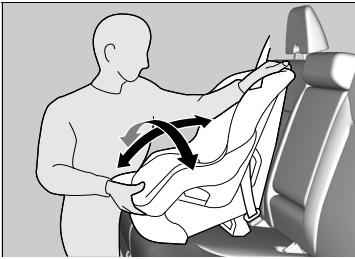

6. Make sure the child restraint system is firmly secured by rocking it forward and back and side to side; little movement should be felt.
7. Make sure any unused seat belt that a child can reach is buckled.

Except European models

If your child restraint system does not come with a mechanism that secures the belt, install a locking clip on the seat belt.

After going through the step 1 and 2, pull up the shoulder part of the belt and make sure there is no slack in the lap portion.

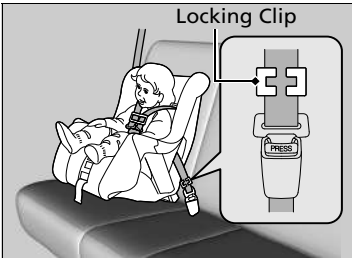

3. Tightly grasp the belt near the latch plate. Pinch both parts of the belt together so they do not slip through the latch plate. Unbuckle the seat belt.
4. Install the locking clip as shown in the image. Position the clip as close as possible to the latch plate.
5. Insert the latch plate into the buckle. Go to step 6 and 7.

Continued

■ Adding Security with a Tether

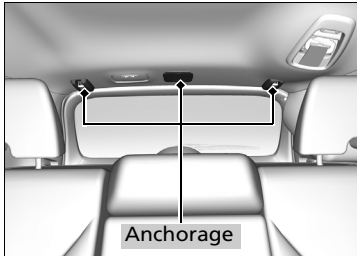

Three tether anchorage points are provided in the ceiling for the rear seats. A child restraint system that is installed with a seat belt and comes with a tether can use the tether for additional security.

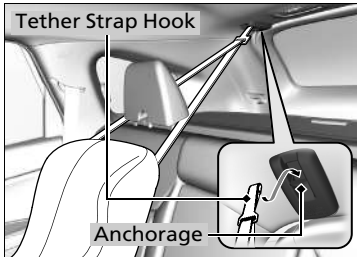

■ Using an outer anchorage

1. Pull up the head restraint and push rearward until it latches, then route the tether strap through the head restraint legs. Make sure the strap is not twisted.
2. Secure the tether strap hook onto the anchorage.
3. Tighten the tether strap as instructed by the child restraint system manufacturer.

▶▶ Adding Security with a Tether

WARNING: Child restraint anchorages are designed to withstand only those loads imposed by correctly fitted child restraints. Under no circumstances are they to be used for adult seat belts, harnesses or for attaching other items or equipment to the vehicle.

Since a tether can provide additional security to the lap/shoulder seat belt installation, we recommend using a tether whenever one is available.

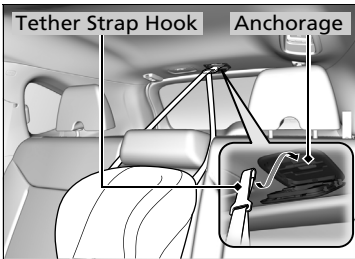

■ Using the centre anchorage

1. Lower the head restraint to its lowest position.
2. Open the anchorage cover.
3. Route the tether strap over the head restraint.
Make sure the strap is not twisted.
4. Secure the tether strap hook onto the anchorage.
5. Tighten the tether strap as instructed by the child restraint system manufacturer.

Safety of Larger Children

■ Protecting Larger Children

The following pages give instructions on how to check proper seat belt fit, what kind of booster seat to use if one is needed, and important precautions for a child who must sit in front.

■ Checking Seat Belt Fit

When a child is too big for a child restraint system, secure the child in a rear seat using the lap/shoulder seat belt. Have the child sit upright and all the way back, then answer the following questions.



■ Checklist

- Do the child's knees bend comfortably over the edge of the seat?
- Does the shoulder belt cross between the child's neck and arm?
- Is the lap part of the seat belt as low as possible, touching the child's thighs?
- Will the child be able to stay seated like this for the whole trip?

If you answer yes to all these questions, the child is ready to wear the lap/shoulder seat belt correctly. If you answer no to any question, the child needs to ride on a booster seat until the seat belt fits properly without a booster seat.

⌘ Safety of Larger Children

⚠ WARNING

Allowing a child aged 12 or under to sit in front can result in injury or death if the passenger's front airbag inflates.

If a larger child must ride in front, move the vehicle seat as far to the rear as possible, have the child sit up properly and wear the seat belt properly, using a booster seat if needed.

Booster Seats



If a lap/shoulder seat belt cannot be used properly, position the child in a booster seat in a rear seating position. For the child's safety, check that the child meets the booster seat manufacturer's recommendations.

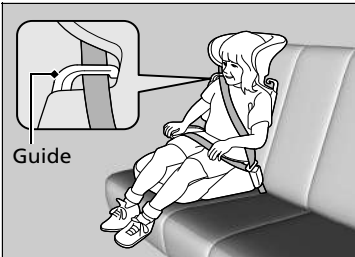

A back-rest is available for a specific booster seat. Install the back-rest to the booster seat and adjust it to the vehicle seat according to the booster seat manufacturer's instructions. Make sure the seat belt is properly routed through the guide at the shoulder of the back-rest and the belt does not touch and cross the child's neck.

Booster Seats

When installing a booster seat, make sure to read the instructions that came with it, and install the seat accordingly. There are high- and low-type booster seats. Choose a booster seat that allows the child to wear the seat belt correctly.

Continued

■ Protecting Larger Children - Final Checks

Your vehicle has a rear seat where children can be properly restrained. If you ever have to carry a group of children, and a child must ride in front:

- Make sure you read and fully understand the instructions and safety information in this manual.
- Move the front passenger seat as far back as possible.
- Have the child sit upright and well back in the seat.
- Check that the seat belt is properly positioned so that the child is secure in the seat.

■ Monitoring child passengers

We strongly recommend that you keep an eye on child passengers. Even older, more mature children sometimes need to be reminded to fasten their seat belts and sit up properly.

Carbon Monoxide Gas

The engine exhaust from this vehicle contains carbon monoxide, a colourless, odourless, and highly toxic gas. As long as you properly maintain your vehicle, carbon monoxide gas will not get into the interior.

■ Have the exhaust system inspected for leaks whenever

- The exhaust system is making an unusual noise.
- The exhaust system may have been damaged.
- The vehicle is raised for an oil change.

When you operate a vehicle with the tailgate open, airflow can pull exhaust gas into the interior and create a hazardous condition. If you must drive with the tailgate open, open all the windows and set the climate control system as shown below.

1. Select the fresh air mode.
2. Select the  mode.
3. Set the fan speed to high.
4. Set the temperature control to a comfortable setting.

Adjust the climate control system in the same manner if you sit in your parked vehicle with the engine running.

☒ Carbon Monoxide Gas

⚠ WARNING

Carbon monoxide gas is toxic.

Breathing it can cause unconsciousness and even kill you.

Avoid any enclosed areas or activities that expose you to carbon monoxide.

An enclosed area such as a garage can quickly fill up with carbon monoxide gas.
Do not run the engine with the garage door closed.
Even when the garage door is open, drive out of the garage immediately after starting the engine.

Label Locations

These labels are in the locations shown. They warn you of potential hazards that can cause serious injury or death. Read these labels carefully.

If a label comes off or becomes hard to read, contact a dealer for a replacement.

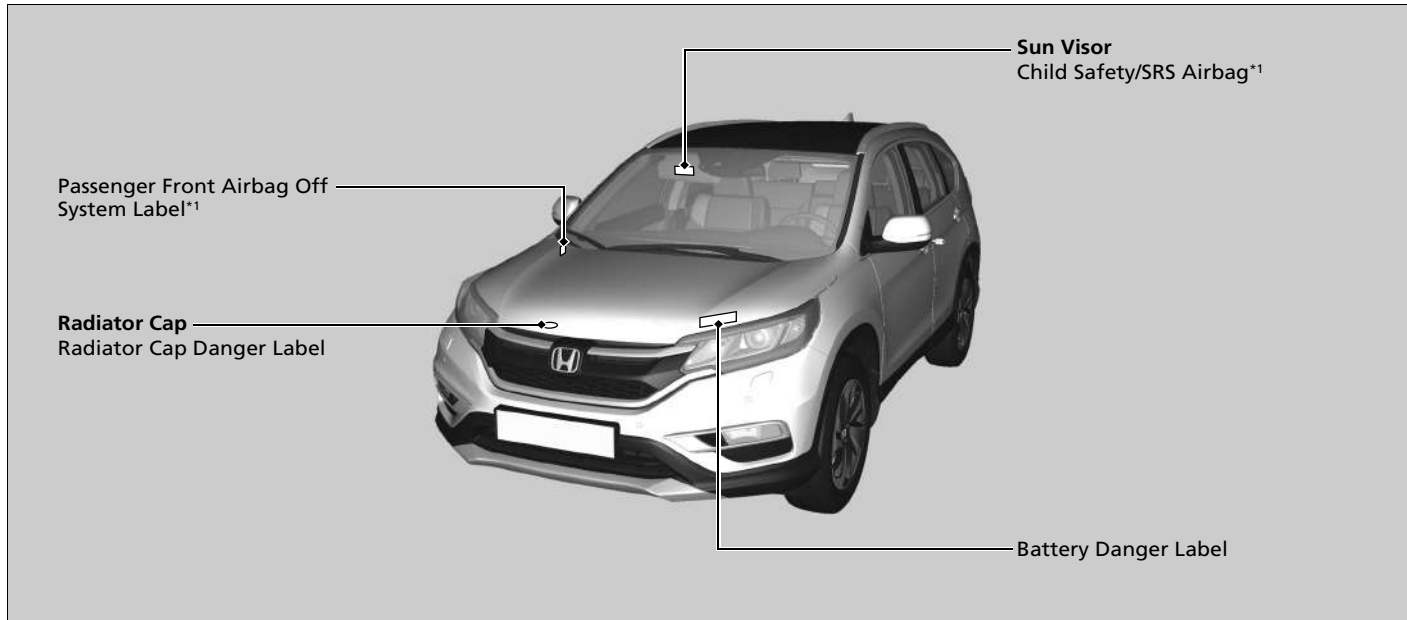

*1: Left-hand drive models shown. For the right-hand drive models, these labels are located at the symmetrically opposite to the left-hand drive model.





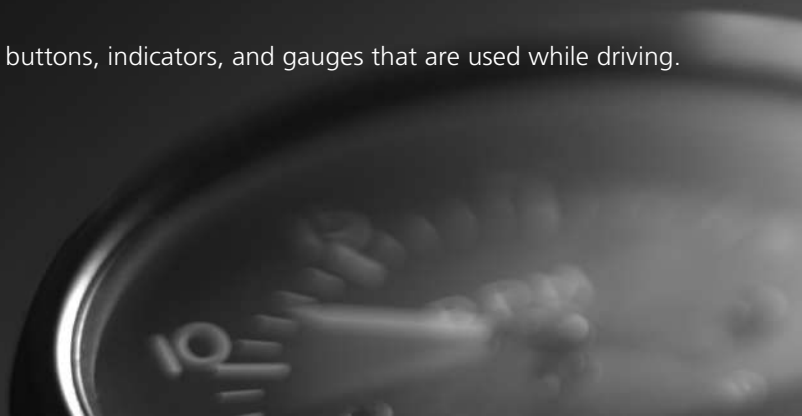

Instrument Panel

This chapter describes the buttons, indicators, and gauges that are used while driving.







Indicators	84
Display Warning and Information Messages	108
Gauges and Displays	
Gauges	128
Multi-Information Display	129
i-Multi-Information Display	143









Indicators

Indicator	Name	On/Blinking	Explanation	Message
 (Red)	Parking Brake and Brake System Indicator (Red)	<ul style="list-style-type: none"> • Comes on for a few seconds when you turn the ignition switch to ON ^{*1}, then goes off if the parking brake has been released. • Comes on when the parking brake is applied and goes off when it is released. • Comes on when the brake fluid level is low. • Comes on if there is a problem with the brake system. • The beeper sounds and the indicator comes on if you drive with the parking brake not fully released. 	<ul style="list-style-type: none"> • Comes on while driving - Make sure the parking brake is released. Check the brake fluid level. <ul style="list-style-type: none"> ➤ What to do when the indicator comes on while driving P. 634 • Comes on along with the ABS indicator - Have your vehicle checked by a dealer. <ul style="list-style-type: none"> ➤ If the Brake System Indicator (Red) Comes On P. 634 	 
 (Amber)	Brake System Indicator (Amber)	<ul style="list-style-type: none"> • Comes on for a few seconds when you turn the ignition switch to ON ^{*1}, then goes off. • Comes on if there is a problem with a system related to braking other than the conventional brake system. 	<ul style="list-style-type: none"> • Stays on constantly - Have your vehicle checked by a dealer. 	—
		<ul style="list-style-type: none"> • Comes on if there is a problem with the City-Brake Active system*. 	<ul style="list-style-type: none"> • Comes on along with the CTBA indicator - The City-Brake Active system does not activate. Have your vehicle checked by a dealer. <ul style="list-style-type: none"> ➤ City-Brake Active system* P. 502 	

*1: Models with the keyless access system have an **ENGINE START/STOP** button instead of an ignition switch.

Indicator	Name	On/Blinking	Explanation	Message
	Low Oil Pressure Indicator	<ul style="list-style-type: none"> • Comes on when you turn the ignition switch to ON [II]*1, and goes off when the engine starts. • Comes on when the engine oil pressure is low. 	<ul style="list-style-type: none"> • Comes on while driving - Immediately stop in a safe place. <ul style="list-style-type: none"> ➤ If the Low Oil Pressure Indicator Comes On P. 633 Diesel models <ul style="list-style-type: none"> ➤ Starting the Engine P. 397, 400 	
	Malfunction Indicator Lamp	<ul style="list-style-type: none"> • Comes on when you turn the ignition switch to ON [II]*1, and goes off when the engine starts, or after several seconds if the engine did not start. • Comes on if there is a problem with the emissions control systems. • Blinks when a misfire in the engine's cylinders is detected. 	<ul style="list-style-type: none"> • Comes on while driving - Have your vehicle checked by a dealer. • Shows the self-testing condition of the diagnostics of the emission control system. • Blinks while driving - Stop in a safe place where there are no flammable objects. Stop the engine for 10 minutes or more, and wait for it to cool down. Then, take your vehicle to a dealer. <ul style="list-style-type: none"> ➤ If the Malfunction Indicator Lamp Comes On or Blinks P. 634 	





*1: Models with the keyless access system have an **ENGINE START/STOP** button instead of an ignition switch.

Indicator	Name	On/Blinking	Explanation	Message
	Charging System Indicator	<ul style="list-style-type: none"> Comes on when you turn the ignition switch to ON ^{*1}, and goes off when the engine starts. Comes on when the battery is not charging. 	<ul style="list-style-type: none"> Comes on while driving - Turn off the climate control system and rear demister to reduce electricity consumption. <ul style="list-style-type: none"> ➔ If the Charging System Indicator Comes On P. 633 	
	Shift Lever Position Indicator ^{*2}	<ul style="list-style-type: none"> Indicates current the shift lever position. 	<ul style="list-style-type: none"> ➔ Shifting P. 406 	—
	Gear Position Indicator ^{*3}	<ul style="list-style-type: none"> Indicates the current gear selection. 	<ul style="list-style-type: none"> ➔ Shifting P. 411 	—
	Transmission Indicator ^{*2}	<ul style="list-style-type: none"> Comes on for a few seconds when you turn the ignition switch to ON ^{*1}, then goes off. Blinks if the transmission system has a problem. 	<ul style="list-style-type: none"> Blinks while driving - Avoid sudden starts and acceleration and have your vehicle checked by a dealer immediately. 	





*1: Models with the keyless access system have an **ENGINE START/STOP** button instead of an ignition switch.

*2: 5-speed automatic transmission models

*3: 9-speed automatic transmission models

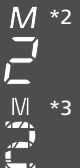
Indicator	Name	On/Blinking	Explanation	Message
	Transmission Indicator* ¹	<ul style="list-style-type: none"> The indicated current gear selection blinks if there is a problem with the transmission system. 	<ul style="list-style-type: none"> Avoid sudden start and acceleration, and stop in a safe place immediately. Have your vehicle checked by a dealer. 	
		<ul style="list-style-type: none"> The indicated current gear selection or all the gear positions blink if there is a problem with the transmission system, and the vehicle no longer moves. 	<ul style="list-style-type: none"> Immediately stop in a safe place. <ul style="list-style-type: none"> ➤ Emergency Towing P. 647 Have your vehicle checked by a dealer. 	
		<ul style="list-style-type: none"> The indicated current gear selection or all the gear positions blink if you cannot select P due to the transmission system failure. 	<ul style="list-style-type: none"> The engine can be activated as a temporary measure. <ul style="list-style-type: none"> ➤ If the Transmission Indicator Blinks along with the Warning Message P. 638 Set the parking brake when parking. Have your vehicle checked by a dealer immediately. 	



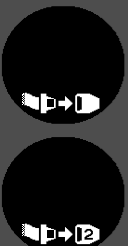



*1:9-speed automatic transmission models

Indicator	Name	On/Blinking	Explanation	Message
	M (sequential shift mode) Indicator/Gear Position Indicator*	<ul style="list-style-type: none"> Comes on when the manual sequential shift mode is applied. 	 Sequential Shift Mode P. 408	—
	Seat Belt Reminder Indicator	<ul style="list-style-type: none"> Comes on if you are not wearing a seat belt when you turn the ignition switch to ON *1. If the front passenger is not wearing a seat belt, the indicator comes on a few seconds later. Blinks during driving if either you or the front passenger has not fastened a seat belt. The beeper sounds and the indicator blinks at regular intervals. 	<ul style="list-style-type: none"> The beeper stops and the indicator goes off when you and the front passenger fasten their seat belts. Stays on after you or the front passenger has fastened the seat belt - A detection error may have occurred in the sensor. Have your vehicle checked by a dealer.  Seat Belt Reminder P. 41	







*1: Models with the keyless access system have an **ENGINE START/STOP** button instead of an ignition switch.

*2: 5-speed automatic transmission models



*3: 9-speed automatic transmission models

Indicator	Name	On/Blinking	Explanation	Message
	Low Fuel Indicator	<ul style="list-style-type: none"> • Comes on when the fuel reserve is running low (approximately 8.6 Litres/ 1.89 Imp gal left). • Blinks if there is a problem with the fuel gauge. 	<ul style="list-style-type: none"> • Comes on - Refuel your vehicle as soon as possible. • Blinks - Have your vehicle checked by a dealer. 	
		<p>Diesel models</p> <ul style="list-style-type: none"> • Appears when the Range on the multi-information display reaches to 0. 	<ul style="list-style-type: none"> • Maximum speed is restricted. • Refuel your vehicle as soon as possible. The vehicle speed limit will be released when refueling 10 Litres (2.2 Imp gal) or more. <p>➔ Refueling P. 522</p>	
		<p>Diesel models</p> <ul style="list-style-type: none"> • Appears when the remaining fuel is nearly-empty. 	<ul style="list-style-type: none"> • The vehicle stops soon. • You cannot restart the engine. Immediately refuel your vehicle. <p>➔ Refueling P. 522</p>	
	<p>Diesel models</p> Glow Plugs Indicator	<ul style="list-style-type: none"> • Comes on for a few seconds when you turn the ignition switch to ON *1, then goes off. • Comes on for a while when you turn the ignition switch to ON *1 under the extremely low engine coolant temperature condition, then goes off. 	<ul style="list-style-type: none"> • Stays on - The engine is cold. Do not start the engine until the indicator goes off. ➔ Starting the Engine P. 397 • If you still find it hard to start the engine, have your vehicle inspected by your dealer. 	—







*1: Models with the keyless access system have an **ENGINE START/STOP** button instead of an ignition switch.

Indicator	Name	On/Blinking	Explanation	Message
	Anti-lock Brake System (ABS) Indicator	<ul style="list-style-type: none"> • Comes on for a few seconds when you turn the ignition switch to ON ^{*1}, then goes off. • If it comes on at any other time, there is a problem with the ABS. 	<ul style="list-style-type: none"> • Stays on constantly - Have your vehicle checked by a dealer. With this indicator on, your vehicle still has normal braking ability but no anti-lock function.  Anti-lock Brake System (ABS) P. 490 	
	Supplemental Restraint System Indicator	<ul style="list-style-type: none"> • Comes on for a few seconds when you turn the ignition switch to ON ^{*1}, then goes off. • Comes on if a problem with any of the following is detected: <ul style="list-style-type: none"> - Supplemental restraint system - Side airbag system - Side curtain airbag system - Seat belt tensioner 	<ul style="list-style-type: none"> • Stays on constantly or does not come on at all - Have your vehicle checked by a dealer. 	









*1: Models with the keyless access system have an **ENGINE START/STOP** button instead of an ignition switch.

Indicator	Name	On/Blinking	Explanation	Message
	Passenger Front Airbag On/Off Indicator	<ul style="list-style-type: none"> Both indicators come on for a few seconds when you turn the ignition switch to ON [II]*1, then goes off after a system check up. When the passenger front airbag is active: The on indicator comes back on and remains on for about 60 seconds. When the passenger front airbag is inactive: The off indicator comes back on and stays on. This is a reminder that the passenger front airbag is deactivated. 	 Passenger Front Airbag Off System P. 54	

*1: Models with the keyless access system have an **ENGINE START/STOP** button instead of an ignition switch.







Indicator	Name	On/Blinking	Explanation	Message
	Vehicle Stability Assist (VSA) System Indicator	<ul style="list-style-type: none"> • Comes on for a few seconds when you turn the ignition switch to ON ^{*1}, then goes off. • Blinks when VSA, or trailer stability assist is active. • Comes on if there is a problem with the VSA, hill start assist, trailer stability assist or brake lighting system. 	<ul style="list-style-type: none"> • Stays on constantly - Have your vehicle checked by a dealer. <ul style="list-style-type: none"> ➤ Vehicle Stability Assist (VSA) System P. 478 ➤ Trailer Stability Assist P. 391 	
	VSA OFF Indicator	<ul style="list-style-type: none"> • Comes on for a few seconds when you turn the ignition switch to ON ^{*1}, then goes off. • Comes on when you deactivate VSA. 	<ul style="list-style-type: none"> ➤ VSA On and Off P. 479 	—
	Hill Descent Control System Indicator*	<ul style="list-style-type: none"> • Comes on for a few seconds when you turn the ignition switch to ON ^{*1}, then goes off. • Comes on when the hill descent control system is on and ready to use. • Blinks when the hill descent control system is in operation. 	<ul style="list-style-type: none"> ➤ Hill Descent Control System* P. 489 	—

*1: Models with the keyless access system have an **ENGINE START/STOP** button instead of an ignition switch.







Indicator	Name	On/Blinking	Explanation	Message
	Electric Power Steering (EPS) System Indicator	<ul style="list-style-type: none"> • Comes on when you turn the ignition switch to ON ^{*1}, and goes off when the engine starts. • Comes on if there is a problem with the EPS system. 	<ul style="list-style-type: none"> • Stays on constantly or does not come on at all - Have your vehicle checked by a dealer. <ul style="list-style-type: none"> ► If the Electric Power Steering (EPS) System Indicator Comes On P. 635 	
	Low Tyre Pressure/Deflation Warning System Indicator	<ul style="list-style-type: none"> • Comes on for a few seconds when you turn the ignition switch to ON ^{*1}, then goes off. • May come on briefly if the ignition switch is turned to ON ^{*1} and the vehicle is not moved within 45 seconds, to indicate the calibration process is not yet complete. • Comes on and stays on when: <ul style="list-style-type: none"> - One or more tyres' pressures are determined to be significantly low. - The system has not been calibrated. • Blinks for about one minute, and then stays on if there is a problem with the deflation warning system, or when a compact spare tyre* is temporarily installed. 	<ul style="list-style-type: none"> • Comes on while driving - Stop in a safe place, check tyre pressures, and inflate the tyre(s) if necessary. • Stays on after the tyres are inflated to the recommended pressures - The system needs to be calibrated. <ul style="list-style-type: none"> ► Deflation Warning System Calibration P. 484 • Blinks and remains on - Have your vehicle checked by a dealer. If the vehicle is fitted with a compact spare, get your regular tyre repaired or replaced and put back on your vehicle as soon as you can. 	 

*1: Models with the keyless access system have an **ENGINE START/STOP** button instead of an ignition switch.







* Not available on all models

Indicator	Name	On/Blinking	Explanation	Message
	Door and Tailgate Open Indicator	<ul style="list-style-type: none"> • Comes on for a few seconds when you turn the ignition switch to ON ^{*1}, then goes off. • Comes on if any door or the tailgate is not completely closed. • The beeper sounds and the indicator comes on if any door or the tailgate is opened while driving. 	<ul style="list-style-type: none"> • Goes off when all doors and the tailgate are closed. 	
AWD	All-Wheel Drive (AWD) System Indicator*	<ul style="list-style-type: none"> • Comes on for a few seconds when you turn the ignition switch to ON ^{*1}, then goes off. • Comes on if there is a problem with the AWD system. • Blinks when the AWD system is overheated. The system is inactive. 	<ul style="list-style-type: none"> • Stays on constantly - the engine drives only the front wheels only in this state. Have your vehicle checked by a dealer. • Blinks while driving - the engine drives the front wheels only in this state. Stop in a safe place, shift to , and idle the engine until the indicator goes off. If the indicator does not stop blinking, take your vehicle to a dealer. <p>➤ REAL TIME AWD with Intelligent Control System* P. 486</p>	











*1: Models with the keyless access system have an **ENGINE START/STOP** button instead of an ignition switch.

Indicator	Name	On/Blinking	Explanation	Message
	System Message Indicator	<ul style="list-style-type: none"> • Comes on for a few seconds when you turn the ignition switch to ON *1, then goes off. • Comes on along with a beep when a problem is detected. A system message on the multi-information display appears at the same time. 	<ul style="list-style-type: none"> • While the indicator is on, press the /▼ (information) button to see the message again. • Refer to the Indicators information in this chapter when a system message appears on the multi-information display. Take the appropriate action for the message. • The multi-information display does not return to the normal screen unless the warning is cancelled, or the  button is pressed. 	—
	Turn Signal and Hazard Warning Indicators	<ul style="list-style-type: none"> • Blinks when you operate the turn signal lever. • Blinks along with all turn signals if you press the hazard warning button. • If you depress the brake pedal while the high speed driving, both indicators and all turn signals blink at the four times. 	<ul style="list-style-type: none"> • Does not blink or blinks rapidly - A turn signal light bulb has blown. Change the bulb immediately.  Replacing Light Bulbs P. 566, 567, 569 	—
	High Beam Indicator	<ul style="list-style-type: none"> • Comes on when the high beam headlights are on. 	—	—

*1:Models with the keyless access system have an **ENGINE START/STOP** button instead of an ignition switch.







Indicator	Name	On/Blinking	Explanation	Message
	Lights On Indicator	<ul style="list-style-type: none"> Comes on whenever the light switch is on, or in AUTO* when the exterior lights are on. 	<ul style="list-style-type: none"> If you remove the key from the ignition switch*¹ while the lights are on, a chime sounds when the driver's door is opened. 	—
	Front Fog Light Indicator*	<ul style="list-style-type: none"> Comes on when the front fog lights are on. 	—	—
	Rear Fog Light Indicator	<ul style="list-style-type: none"> Comes on when the rear fog light is on. 	—	—
	Immobilizer System Indicator	<ul style="list-style-type: none"> Comes on briefly when you turn the ignition switch to ON ^{*1}, then goes off. Comes on if the immobilizer system cannot recognize the key information. 	<ul style="list-style-type: none"> Blinks - You cannot start the engine. Turn the ignition switch to LOCK ^{*1}, pull the key out, and then insert the key and turn it to ON ^{*1} again. Repeatedly blinks - The system may be malfunctioning. Have your vehicle checked by a dealer. Do not attempt to alter this system or add other devices to it. Electrical problems can occur. 	—

*1: Models with the keyless access system have an **ENGINE START/STOP** button instead of an ignition switch.







Indicator	Name	On/Blinking	Explanation	Message
	Security System Alarm Indicator*	<ul style="list-style-type: none"> Blinks when the security system alarm has been set. 	<p>➤ Security System Alarm* P. 176</p>	—
	Keyless Access System Indicator*	<ul style="list-style-type: none"> Comes on for a few seconds when you set the power mode to ON, then goes off. Comes on as soon as a problem is detected in the keyless access system or keyless starting system. 	<ul style="list-style-type: none"> Have your vehicle checked by a dealer. 	
	ECON Mode Indicator	<ul style="list-style-type: none"> Comes on for a few seconds when you turn the ignition switch to ON ^{*1}, then goes off. Comes on when the ECON mode is on. 	<p>➤ ECON Button P. 430</p>	
	Shift Up Indicator	<ul style="list-style-type: none"> Comes on briefly when you turn the ignition switch to ON ^{*1}, then goes off. Comes on when shifting up is recommended. 	<p>➤ Shift Up/Down Indicators P. 410, 419, 421</p>	—
	Shift Down Indicator*	<ul style="list-style-type: none"> Comes on briefly when you turn the ignition switch to ON ^{*1}, then goes off. Comes on when shifting down is recommended. 	<p>➤ Shift Up/Down Indicators P. 410, 419, 421</p>	—

*1: Models with the keyless access system have an **ENGINE START/STOP** button instead of an ignition switch.









* Not available on all models

Indicator	Name	On/Blinking	Explanation	Message
ACC	Adaptive Cruise Control (ACC) Indicator*	<ul style="list-style-type: none"> Comes on for a few seconds when you turn the ignition switch to ON ^{*1}, then goes off. Comes on if there is a problem with ACC. 	<ul style="list-style-type: none"> Comes on - Have your vehicle checked by a dealer. 	
		<ul style="list-style-type: none"> Comes on if anything covers the radar sensor cover and prevents the sensor from detecting a vehicle in front. May come on when driving in bad weather (rain, snow, fog, etc.) ACC has been automatically cancelled. 	<ul style="list-style-type: none"> When the radar sensor gets dirty, stop your vehicle in a safe place, and wipe off dirt using soft cloth. Have your vehicle checked by a dealer if the message does not disappear even after you clean the sensor cover. <ul style="list-style-type: none"> ➤ Adaptive Cruise Control (ACC)* P. 441 	
	Collision Mitigation Braking System (CMBS) Indicator*	<ul style="list-style-type: none"> Comes on for a few seconds when you turn the ignition switch to ON ^{*1}, then goes off. Comes on when you deactivate the CMBS. A multi-information display message appears for five seconds. Comes on if there is a problem with the CMBS. 	<ul style="list-style-type: none"> Stays on constantly without the CMBS off - Have your vehicle checked by a dealer. <ul style="list-style-type: none"> ➤ Collision Mitigation Braking System (CMBS)* P. 493 	 





*1: Models with the keyless access system have an **ENGINE START/STOP** button instead of an ignition switch.

Indicator	Name	On/Blinking	Explanation	Message
	Collision Mitigation Braking System (CMBS) Indicator*	<ul style="list-style-type: none"> Comes on when the CMBS system shuts itself off. 	<ul style="list-style-type: none"> Stays on - The area around the camera is blocked by dirt, mud, etc. Stop your vehicle in a safe place, and wipe it off with a soft cloth.  Front Sensor Camera* P. 439 	
		<ul style="list-style-type: none"> When the radar sensor gets dirty, stop your vehicle in a safe place, and wipe off dirt using a soft cloth. Have your vehicle checked by a dealer if the message does not disappear even after you clean the sensor cover.  Collision Mitigation Braking System (CMBS)* P. 493 	<ul style="list-style-type: none"> When the radar sensor gets dirty, stop your vehicle in a safe place, and wipe off dirt using a soft cloth. Have your vehicle checked by a dealer if the message does not disappear even after you clean the sensor cover. 	
		<ul style="list-style-type: none"> Stays on - The temperature inside the camera is too high. Use the climate control system to cool down the camera. The system activates when the temperature inside the camera cools down.  Front Sensor Camera* P. 439 	<ul style="list-style-type: none"> Stays on - The temperature inside the camera is too high. Use the climate control system to cool down the camera. The system activates when the temperature inside the camera cools down. 	

* Not available on all models







Indicator	Name	On/Blinking	Explanation	Message
	Forward Collision Warning Indicator*	<ul style="list-style-type: none"> • Comes on for a few seconds when you turn the ignition switch to ON ^{*1}, then goes off. • Comes on when you have customized forward collision warning system to turn off. • Comes on if there is a problem with the system. 	<ul style="list-style-type: none"> • Stays on constantly without the system off - Have your vehicle checked by a dealer. 	 
		<ul style="list-style-type: none"> • Comes on when the system shuts itself off. 	<ul style="list-style-type: none"> • Stays on - The temperature inside the camera is too high. The system activates when the temperature inside the system cools down.  Automatic shutoff P. 457 	
			<ul style="list-style-type: none"> • Stays on - The area around the camera is blocked by dirt, mud, etc. Stop your vehicle in a safe place, and wipe it off with a soft cloth. • Have your vehicle checked by a dealer if the indicator and message come back on after you cleaned the area around the camera.  Automatic shutoff P. 457 	







*1: Models with the keyless access system have an **ENGINE START/STOP** button instead of an ignition switch.

Indicator	Name	On/Blinking	Explanation	Message
	Forward Collision Warning Indicator*	<ul style="list-style-type: none"> • Comes on if anything covers the radar sensor cover and prevents the sensor from detecting a vehicle in front. • May come on when driving in bad weather (rain, snow, fog, etc.) 	<ul style="list-style-type: none"> • When the radar sensor gets dirty, stop your vehicle in a safe place, and wipe off dirt using a soft cloth. • Have your vehicle checked by a dealer if the message does not disappear even after you clean the sensor cover. 	
	Lane Departure Warning Indicator*	<ul style="list-style-type: none"> • Comes on for a few seconds when you turn the ignition switch to ON *1, then goes off. • Comes on if there is a problem with the lane departure warning system. 	<ul style="list-style-type: none"> • Stays on constantly - Have your vehicle checked by a dealer. 	







* 1: Models with the keyless access system have an **ENGINE START/STOP** button instead of an ignition switch.

* Not available on all models



Indicator	Name	On/Blinking	Explanation	Message
	Lane Departure Warning Indicator*	<ul style="list-style-type: none"> Comes on when the system shuts itself off. 	<ul style="list-style-type: none"> Stays on - The temperature inside the camera is too high. Use the climate control system to cool down the camera. The system activates when the temperature inside the camera cools down.  Lane Departure Warning* P. 459 	
		<ul style="list-style-type: none"> Comes on if anything covers the radar sensor cover and prevents the sensor from detecting a vehicle in front. May come on when driving in bad weather (rain, snow, fog, etc.) 	<ul style="list-style-type: none"> Stays on - The area around the camera is blocked by dirt, mud, etc. Stop your vehicle in a safe place, and wipe it off with a soft cloth. Have your vehicle checked by a dealer if the indicator and message come back on after you cleaned the area around the camera.  Lane Departure Warning* P. 459 	
		<ul style="list-style-type: none"> Comes on if anything covers the radar sensor cover and prevents the sensor from detecting a vehicle in front. May come on when driving in bad weather (rain, snow, fog, etc.) 	<ul style="list-style-type: none"> When the radar sensor gets dirty, stop your vehicle in a safe place, and wipe off dirt using a soft cloth. Have your vehicle checked by a dealer if the message does not disappear even after you clean the sensor cover. 	

Indicator	Name	On/Blinking	Explanation	Message
	Lane Keeping Assist System (LKAS) Indicator*	<ul style="list-style-type: none"> Comes on for a few seconds when you turn the ignition switch to ON *¹, then goes off. Comes on if there is a problem with the LKAS. 	<ul style="list-style-type: none"> Comes on - Have your vehicle checked by a dealer. 	
	High Beam Support System Indicator*	<ul style="list-style-type: none"> Comes on for a few seconds when you turn the ignition switch to ON *¹, then goes off. Comes on when all the operating conditions of the high beam support system are met. 	<ul style="list-style-type: none">  High Beam Support System * P. 194 	



* 1: Models with the keyless access system have an **ENGINE START/STOP** button instead of an ignition switch.







Indicator	Name	On/Blinking	Explanation	Message
	Blind Spot Information Indicator*	<ul style="list-style-type: none"> • Comes on for a few seconds when you turn the ignition switch to ON ^{*1}, then goes off. • Stays on while the blind spot information system is turned off. 	—	
		<ul style="list-style-type: none"> • Comes on when mud, snow, or ice accumulates in the vicinity of sensor. 	<ul style="list-style-type: none"> • Comes on while driving - Remove the obstacle in the vicinity of sensor.  Blind Spot Information System* P. 481 	
		<ul style="list-style-type: none"> • Comes on if there is a problem with the system. 	<ul style="list-style-type: none"> • Comes on while driving - Have your vehicle checked by a dealer. 	

*1: Models with the keyless access system have an **ENGINE START/STOP** button instead of an ignition switch.

Indicator	Name	On/Blinking	Explanation	Message
<p style="text-align: center; font-size: 2em; font-weight: bold;">CTBA</p>	<p style="text-align: center;">City-Brake Active System (CTBA) Indicator*</p>	<ul style="list-style-type: none"> • Comes on for a few seconds when you turn the ignition switch to ON *, then goes off. 	—	—
		<ul style="list-style-type: none"> • Goes off when you have customized the City-Brake Active system to turn on. • Comes on when you have customized the City-Brake Active system to turn off. 	<ul style="list-style-type: none"> ➤ City-Brake Active system* P. 502 ➤ Customized Features P. 133 	—
		<ul style="list-style-type: none"> • Comes on when the area around the laser sensor, which is located in the upper part of the windscreen, is covered with obstacles, such as dirt, ice and frost. • May come on when driving in bad weather (rain, fog, snow). 	<ul style="list-style-type: none"> • Remove the dirt or any obstacles using the washer and wipers. • Stop your vehicle in a safe place and wipe away dirt or any obstacles covering the area around the laser sensor on the windscreen. ➤ City-Brake Active system* P. 502 • The system resumes when obstacles are removed. 	
		<ul style="list-style-type: none"> • Comes on when snow is accumulated on the bonnet. 	<ul style="list-style-type: none"> • Stop your vehicle in a safe place and remove snow from the bonnet. 	

* Not available on all models

Indicator	Name	On/Blinking	Explanation	Message
<p>CTBA</p>	<p>City-Brake Active System (CTBA) Indicator*</p>	<ul style="list-style-type: none"> • May come on when the temperatures of the area around the laser sensor are high. 	<ul style="list-style-type: none"> • Use the climate control system to cool down the area around the laser sensor. • The system resumes when the temperatures of the area around the laser sensor go down. 	
		<ul style="list-style-type: none"> • Comes on along with the brake system indicator (amber) if there is a problem with the system. 	<ul style="list-style-type: none"> • The system does not activate. Have your vehicle checked by a dealer. 	









Indicator	Name	On/Blinking	Explanation	Message
	Auto Idle Stop Indicator (Green)*	<ul style="list-style-type: none"> • Comes on when Auto Idle Stop is in operation. The engine automatically shuts off. 	<ul style="list-style-type: none"> ➔ Auto Idle Stop P. 427 	
		<p>Manual transmission models</p> <ul style="list-style-type: none"> • Blinks when the ambient conditions may cause the windows to fog up. • Blinks when the ambient conditions may become different from the climate control settings you have selected. 	<ul style="list-style-type: none"> • Depress the clutch pedal. The engine automatically restarts. ➔ Auto Idle Stop P. 427 	
	Auto Idle Stop System Indicator (Amber)*	<ul style="list-style-type: none"> • Comes on for a few seconds when you turn the ignition switch to ON *1, then goes off. • Comes on if there is a problem with the Auto Idle Stop system. • Comes on when Auto Idle Stop cannot activate because there is a problem with the battery or charging system. 	<ul style="list-style-type: none"> • Stays on constantly or does not come on at all - Have your vehicle checked by a dealer. 	 





*1: Models with the keyless access system have an **ENGINE START/STOP** button instead of an ignition switch.

* Not available on all models





Display Warning and Information Messages









The following messages appear only on the multi-information display or i-multi-information display. Press the  (information) button to see the message again with the system message indicator on.

Message	Condition	Explanation
	<ul style="list-style-type: none"> Appears when the ignition key is turned to ACCESSORY  from ON . (The driver's door is closed.) 	—
	<ul style="list-style-type: none"> Appears when you open the driver's door while the ignition key is in ACCESSORY . 	<ul style="list-style-type: none"> Turn the ignition switch to LOCK , then remove the key.
	<ul style="list-style-type: none"> Appears when you open the driver's door while the ignition key is in LOCK . 	<ul style="list-style-type: none"> Remove the key from the ignition switch.

Message	Condition	Explanation
 <p data-bbox="102 376 459 423">Models with rearview camera system Models without navigation system</p> 	<ul style="list-style-type: none"> • Appears if there is a problem with the parking sensor system*. 	<ul style="list-style-type: none"> • Check if the area around the sensor(s) is covered with mud, ice, snow, etc. If the indicator(s) stays on even after you clean the area, have the system checked by a dealer.
 <p data-bbox="102 695 459 742">Models with rearview camera system Models without navigation system</p> 	<ul style="list-style-type: none"> • If there is a problem with any of the sensors, the appropriate sensor indicator(s) comes on and stays on in this warning symbol. 	





* Not available on all models



Message	Condition	Explanation
	<ul style="list-style-type: none"> Appears when the engine oil level is low while the engine is running. 	<ul style="list-style-type: none"> Appears while driving - Immediately stop in a safe place. <ul style="list-style-type: none"> ➤ If the Low Oil Level Indicator Comes On P. 637
	<ul style="list-style-type: none"> Appears when the engine is running, there is a system problem in the engine oil level sensor. 	<ul style="list-style-type: none"> Have your vehicle checked by a dealer.
	<ul style="list-style-type: none"> Appears when the vehicle speed reaches the set speed. You can set two different speeds for the alarm. 	<ul style="list-style-type: none"> ➤ List of customizable options P. 148
	<ul style="list-style-type: none"> Appears if there is a problem with the automatic lighting control system*. 	<ul style="list-style-type: none"> Appears while driving - Manually turn the lights on, and have your vehicle checked by a dealer.

Message	Condition	Explanation
	<ul style="list-style-type: none"> Appears once if the outside temperature is below 3°C while the ignition switch is in ON *1. 	<ul style="list-style-type: none"> There is a possibility that the road surface is icy and slippery.
	<ul style="list-style-type: none"> Appears when any of the rear seat belts are latched or unlatched, or either rear door is opened and closed. 	<p> Seat Belt Reminder P. 41</p>
	<ul style="list-style-type: none"> Appears when the engine coolant temperature gets abnormally high. 	<p> Overheating P. 631</p>
	<ul style="list-style-type: none"> Appears when there is a problem with the high beam support system*. 	<ul style="list-style-type: none"> If you are driving with the high beam headlights when this happens, the headlights are changed to low beams. Manually operate the headlight switch.
	<p>Models without Forward Collision Warning</p> <ul style="list-style-type: none"> Appears when the high beam support system* camera lens gets dirty. 	<ul style="list-style-type: none"> Stop in a safe place and clean the camera lens with a soft cloth. If the message does not disappear after cleaning the lens, have your vehicle checked by a dealer.

*1: Models with the keyless access system have an **ENGINE START/STOP** button instead of an ignition switch.

* Not available on all models

Message	Condition	Explanation
	<ul style="list-style-type: none"> Appears when any of the service items is required in less than 30 days or by the total estimated driving distance corresponding to the terms of about 30 days. 	<ul style="list-style-type: none"> The remaining distance will be counted down per 10 kilometres/miles. The remaining days will be counted down per day. <ul style="list-style-type: none"> ➤ Service Reminder System P. 531
	<ul style="list-style-type: none"> Appears when any of the service items is required in less than 10 days or by the total estimated driving distance corresponding to the terms of about 10 days. 	<ul style="list-style-type: none"> Have the indicated service performed as soon as possible. <ul style="list-style-type: none"> ➤ Service Reminder System P. 531
 	<ul style="list-style-type: none"> Appears when the indicated maintenance service is still not done after the remaining time or distance reaches 0. 	<ul style="list-style-type: none"> Your vehicle has passed the service required point. Immediately have the service performed and make sure to reset the service reminder. <ul style="list-style-type: none"> ➤ Service Reminder System P. 531



Message	Condition	Explanation
	<ul style="list-style-type: none"> Appears when there is a problem with the power tailgate system*. 	<ul style="list-style-type: none"> Manually open or close the power tailgate. Have your vehicle checked by a dealer.
	<ul style="list-style-type: none"> Appears when there is a problem with the hill descent control system*. 	<ul style="list-style-type: none"> Your vehicle still has normal braking ability. Have your vehicle checked by a dealer.

Models with AWD system

Message	Condition	Explanation
	<ul style="list-style-type: none"> Appears when the differential temperature is too high. 	<ul style="list-style-type: none"> Stop in a safe place, shift to P, and idle the engine until the message goes off. If it does not go off, take your vehicle to a dealer.

* Not available on all models







Models with washer level sensor

Message	Condition	Explanation
	<ul style="list-style-type: none"> Appears when washer fluid gets low. 	<ul style="list-style-type: none"> Refill washer fluid.  Refilling Window Washer Fluid P. 561

Models with ACC





Message	Condition	Explanation
	<ul style="list-style-type: none"> Appears if there is a problem with the e-pretensioner system*. 	<ul style="list-style-type: none"> Have your vehicle checked by a dealer.





Models with LKAS

Message	Condition	Explanation
	<ul style="list-style-type: none"> Blinks when you fail to steer the vehicle. 	<ul style="list-style-type: none"> Operate the steering wheel to resume the LKAS.
	<ul style="list-style-type: none"> Appears when the vehicle is driving out of a detected line. The beeper sounds simultaneously. 	<ul style="list-style-type: none"> Keep the vehicle within the lane you are driving.
	<ul style="list-style-type: none"> Appears when the LKAS is in operation, or the LKAS button is pressed, but the temperature inside the front sensor camera is too high. The LKAS cancels automatically. The beeper sounds simultaneously. 	<ul style="list-style-type: none"> Use the climate control system to cool down the camera. Goes off - The camera has been cooled down. Pressing the LKAS button can resume the system.  Front Sensor Camera* P. 439
	<ul style="list-style-type: none"> Appears when the area around the camera is blocked by dirt, mud, etc. Stop your vehicle in a safe place, and wipe it off with a soft cloth. May appear when driving in bad weather (rain, snow, fog, etc.) 	<ul style="list-style-type: none"> Have your vehicle checked by a dealer if the indicator and message come back on after you cleaned the area around the camera.
	<ul style="list-style-type: none"> Appears when the LKAS button is pressed or the LKAS automatically cancelled. The beeper sounds simultaneously. 	<ul style="list-style-type: none"> If any other system indicators come on, such as the VSA, ABS and brake system, take appropriate action.  Indicators P. 84

* Not available on all models



Models with keyless access system

Message	Condition	Explanation
	<ul style="list-style-type: none"> Appears when you close the door with the power mode in ON without the keyless remote inside the vehicle. 	<ul style="list-style-type: none"> Disappears when you bring the keyless remote back inside the vehicle and close the door. <ul style="list-style-type: none"> ► Keyless Remote Reminder P. 187
	<ul style="list-style-type: none"> Appears when the keyless remote battery becomes weak. 	<ul style="list-style-type: none"> Replace the battery as soon as possible. <ul style="list-style-type: none"> ► Keyless Remote* P. 590
 	<ul style="list-style-type: none"> Appears after you unlock and open the driver's door*. Appears when you set the power mode to ACCESSORY or ON. 	<ul style="list-style-type: none"> ► Starting the Engine P. 400
	<ul style="list-style-type: none"> Appears when the steering wheel is locked. 	<ul style="list-style-type: none"> Move the steering wheel left and right after pressing the ENGINE START/STOP button.

Message	Condition	Explanation
 *1	<ul style="list-style-type: none"> Appears if you press the ENGINE START/STOP button to turn the engine off without the shift lever in [P]. 	<ul style="list-style-type: none"> Press the ENGINE START/STOP button twice after moving the shift lever to [P].
	<ul style="list-style-type: none"> Appears when the power mode is in ACCESSORY. Appears after the driver's door is opened with the power mode is in ACCESSORY. 	<ul style="list-style-type: none"> Press the ENGINE START/STOP button twice with your foot off the brake pedal (automatic transmission) or the clutch pedal (manual transmission) to change the power mode to VEHICLE OFF (LOCK).
	<ul style="list-style-type: none"> Appears if the keyless remote's battery is too weak to start the engine or the key is not within operating range to start the engine. The beeper sounds six times. 	<ul style="list-style-type: none"> Bring the keyless remote in front of the ENGINE START/STOP button to be touched with. <ul style="list-style-type: none"> ☑ If the Keyless Remote Battery is Weak P. 623
	<ul style="list-style-type: none"> Appears when the starter system has a problem. 	<ul style="list-style-type: none"> As a temporary measure, press and hold the ENGINE START/STOP button for 15 seconds while pressing the brake pedal and manually start the engine. Have your vehicle checked by a dealer.

*1:5-speed automatic transmission models

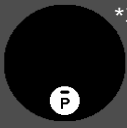

Models with Auto Idle Stop



Message	Condition	Explanation
 *2	<ul style="list-style-type: none"> Appears when you move the shift lever from N to any other position without depressing the clutch pedal while Auto Idle Stop is in operation. 	<ul style="list-style-type: none"> The engine will not start even when the battery charge becomes low. Shift to N to avoid the battery charge becomes low. ➤ Auto Idle Stop P. 423, 427
 *3	<ul style="list-style-type: none"> Appears when the engine stops without the transmission in P, and does not restart automatically. Appears if you open the bonnet while Auto Idle Stop activates. 	<ul style="list-style-type: none"> If you want to turn the ignition switch to LOCK 0*1, change the gear position to P. If you want to start the engine, follow the normal procedure. ➤ Starting the Engine P. 397, 400
 *2	<ul style="list-style-type: none"> Appears in white when you turn the ignition switch to START III*1 before fully depressing the clutch pedal. Appears in white when the ambient conditions may cause the windows to fog up or may become different from the climate control settings you have selected while Auto Idle Stop is in operation. 	<ul style="list-style-type: none"> Depress the clutch pedal.
	<ul style="list-style-type: none"> Appears in amber when the following conditions are kept while Auto Idle Stop is in operation: <ul style="list-style-type: none"> - You are not wearing a seat belt. - The shift lever is in any position except N. 	<ul style="list-style-type: none"> Depress the clutch pedal. Wear the seat belt immediately, and continue to keep the shift lever in N next time Auto Idle Stop activates.

*1: Models with the keyless access system have an **ENGINE START/STOP** button instead of an ignition switch.





*2: Manual transmission models

*3: 9-speed automatic transmission models



Message	Condition	Explanation
	<ul style="list-style-type: none"> • Appears when Auto Idle Stop does not activate because the pressure to the brake pedal is not enough. 	<ul style="list-style-type: none"> • Depress the brake pedal firmly.
	<ul style="list-style-type: none"> • Appears when Auto Idle Stop does not activate for some reason. • Appears when the engine restarts automatically. 	<p>➤ Auto Idle Stop Activates When: P. 428</p>
	<ul style="list-style-type: none"> • Appears when Auto Idle Stop does not activate because the engine coolant temperature is low or high. 	<p>➤ Auto Idle Stop does not activate when: P. 428</p>

Message	Condition	Explanation
	<ul style="list-style-type: none"> • Appears when Auto Idle Stop does not activate because the climate control system is in use, and the difference between the set temperature and actual interior temperature becomes significant. <p>9-speed automatic transmission models</p> <ul style="list-style-type: none"> • Appears when the system is under the following conditions while Auto Idle Stop activates: <ul style="list-style-type: none"> - The climate control system is in use, and the difference between the set temperature and actual interior temperature becomes significant. - The humidity in the interior is high. 	<p>➤ Auto Idle Stop Activates When: P. 428</p> <ul style="list-style-type: none"> • The engine restarts automatically in a few seconds.
	<ul style="list-style-type: none"> • Appears when Auto Idle Stop does not activate due to the low battery. • Appears when the engine automatically restarts because Auto Idle Stop is in operation, and the battery charge becomes low. 	<p>➤ Auto Idle Stop P. 427</p> <ul style="list-style-type: none"> • Appears even though the battery is fully charged <ul style="list-style-type: none"> - The system may not read the battery amount correctly after the battery has been charged with the cables connected to the battery. Disconnect the negative (-) cable once and reconnect it again to the battery. Drive for a few minutes.
	<ul style="list-style-type: none"> • Appears when the bonnet is opened. 	<ul style="list-style-type: none"> • Close the bonnet.

Diesel models

Message	Condition	Explanation
	<ul style="list-style-type: none"> • Appears when you need to regenerate the diesel particulate filter (DPF). This is not a DPF failure. 	<p>► Diesel Particulate Filter (DPF) Regeneration * P. 562</p>
	<ul style="list-style-type: none"> • Appears when you ignore . Particulate matter has started clogging the DPF system. This is a problem. 	<ul style="list-style-type: none"> • Have your vehicle checked by a dealer.
	<ul style="list-style-type: none"> • Appears when water has accumulated in the fuel system. • Appears if you have parked your vehicle for an extended period. 	<ul style="list-style-type: none"> • Have a dealer drain off the water from the system as soon as possible. Accumulated water may cause damage to the fuel system.
	<p>Models with keyless access system</p> <ul style="list-style-type: none"> • Appears if the engine is cold when you press the ENGINE START/STOP button. 	<ul style="list-style-type: none"> • The engine automatically starts when the symbol disappears. • If the brake pedal (automatic transmission) or the clutch pedal (manual transmission) is not depressed, the engine cannot start. <p>► Starting the Engine P. 400</p>

* Not available on all models

Message	Condition	Explanation
	<ul style="list-style-type: none"> • Appears during driving if there is a problem with the engine control system. 	<p> If the PGM-FI Symbol Appears P. 637</p>
	<ul style="list-style-type: none"> • Appears when you cannot restart the engine after the fuel tank has been run dry. Air may have entered the fuel system. 	<ul style="list-style-type: none"> • Have your vehicle checked by a dealer.
	<ul style="list-style-type: none"> • Appears if you do not use the proper fuel for the climate or regional conditions. 	<ul style="list-style-type: none"> • Use of inadequate fuel may reduce engine power.  Fuel recommendation P. 523

Models with ACC, CMBS, forward collision warning



Message	Condition	Explanation
	<ul style="list-style-type: none"> Flashes when the system senses a likely collision with a vehicle in front of you. The beeper sounds. 	<ul style="list-style-type: none"> Take the appropriate means to prevent a collision (apply the brakes, change lanes, etc.) <ul style="list-style-type: none"> ➤ Adaptive Cruise Control (ACC)* P. 441 ➤ Forward Collision Warning* P. 455 ➤ Collision Mitigation Braking System (CMBS)* P. 493

Models with lane departure warning



Message	Condition	Explanation
	<ul style="list-style-type: none"> Appears when your vehicle is too close to the traffic lane lines. The beeper sounds. 	<ul style="list-style-type: none"> Take appropriate action to keep your vehicle within the lane lines. <ul style="list-style-type: none"> ➤ Lane Departure Warning* P. 459

* Not available on all models





Models with ACC





Message	Condition	Explanation
	<ul style="list-style-type: none"> Appears when the system predicts the vehicle cutting in in front of you from the right and decrease your vehicle speed according to the cut-in vehicle. 	<ul style="list-style-type: none"> The system automatically keeps a safe distance from the cut-in vehicle when the system predicts the cutting in. <ul style="list-style-type: none"> ► How the system activates P. 454
	<ul style="list-style-type: none"> Appears when the system predicts the vehicle cutting in in front of you from the left and decrease your vehicle speed according to the cut-in vehicle. 	<ul style="list-style-type: none"> The system automatically keeps a safe distance from the cut-in vehicle when the system predicts the cutting in. <ul style="list-style-type: none"> ► How the system activates P. 454



Models with City-Brake Active system

Message	Condition	Explanation
	<ul style="list-style-type: none"> Flashes when the system senses a likely collision with a vehicle in front of you. The beeper sounds. 	<ul style="list-style-type: none"> Depress the brake pedal, and keep an appropriate distance from the vehicle ahead. The alert will disappear. The system automatically applies the brake if a possible collision becomes likely unavoidable. <ul style="list-style-type: none"> ► City-Brake Active system * P. 502
	<ul style="list-style-type: none"> Changes the display when your vehicle is stopped by the system. The beeper stops. 	

9-speed automatic transmission models

Message	Condition	Explanation
	<ul style="list-style-type: none"> • Appears when the transmission system temperature is too high. The vehicle does not operate properly. 	<ul style="list-style-type: none"> • You may find it difficult to accelerate, or to start the vehicle on uphill. • Stop in a safe place in [P]. • Let the engine idle until the message disappears.
	<ul style="list-style-type: none"> • Appears when you try to change the gear position without depressing the brake pedal. 	<ul style="list-style-type: none"> • Depress the brake pedal, then change the gear position. • In freezing or sub-freezing conditions, the electronic gear selector response may be slow. Always depress the brake pedal before changing the gear position to [P], and confirm that [P] is shown on the gear position indicator before releasing the brake.
	<ul style="list-style-type: none"> • Appears if you change the gear position to [P] without depressing the brake pedal. 	<ul style="list-style-type: none"> • Depress the brake pedal, then change the gear position to [P].
	<ul style="list-style-type: none"> • Appears when you try to change the gear position without releasing your foot off the accelerator pedal. 	<ul style="list-style-type: none"> • Release your foot off the accelerator pedal, then change the gear position.

Message	Condition	Explanation
	<ul style="list-style-type: none"> Appears when the [P] button is pressed while the vehicle is moving. Appears if you change the gear position to [R] while the vehicle is moving forward, or to [D] while the vehicle is reversing. 	<ul style="list-style-type: none"> Make sure that the vehicle comes to a stop before operating the shift lever.
	<ul style="list-style-type: none"> Appears when you attempt to change to another gear position with the transmission in [P] and the engine OFF. 	<ul style="list-style-type: none"> To select another gear position while in [P], the engine must be ON.
	<ul style="list-style-type: none"> Appears when you try to change the gear position after the position has automatically been changed to [P] with the driver's door open and the driver's seat belt unfastened. 	<ul style="list-style-type: none"> Press the park button if you leave the vehicle.
	<ul style="list-style-type: none"> Appears when the vehicle is stopped with the driver's seat belt unfastened and there is a chance that the vehicle may roll unintentionally. <p>Models with keyless access system Appears when you change to [N], and press the ENGINE START/STOP button within five seconds.</p> <p>Models without keyless access system Appears when you change to [N], and turn the ignition switch to ACCESSORY [I] within five seconds.</p>	<ul style="list-style-type: none"> The gear position remains in [N] for 15 minutes, then automatically switches to [P]. <ul style="list-style-type: none"> ➤ If you want to keep the transmission in [N] position [car wash mode] P. 415 Press the [P] button before release the brake pedal when idling, parking or exiting the vehicle. <ul style="list-style-type: none"> ➤ Shift Lever Operation P. 413

Message	Condition	Explanation
	<ul style="list-style-type: none"> • Appears when you attempt to change the gear position to [S] with the transmission not in [D]. 	<ul style="list-style-type: none"> • To change the gear position to [S], the vehicle must be in [D].
	<ul style="list-style-type: none"> • Appears when you set the power mode to ON without fastening the driver's seat belt. • Appears when you change the gear position after [P] has been automatically selected with the driver's door open, the driver's seat belt unfastened, then the brake pedal is released. 	<ul style="list-style-type: none"> • Fasten the seat belt properly before you start to drive. <ul style="list-style-type: none"> ► Shifting P. 411

Gauges and Displays

Gauges

Gauges include the speedometer, tachometer, fuel gauge, and related indicators. They are displayed when the ignition switch is in ON ^{*1}.

■ Speedometer

Displays your driving speed in km/h or mph.

■ Fuel Gauge

Displays the amount of fuel left in the fuel tank.

■ Tachometer

Shows the number of engine revolutions per minute.

■ Temperature Gauge

Displays the temperature of the engine coolant.

⌘ Fuel Gauge

NOTICE

You should refuel when the reading approaches . Running out of fuel can cause the engine to misfire, damaging the catalytic converter.

The actual amount of remaining fuel may differ from the fuel gauge reading.

⌘ Temperature Gauge

Driving with the temperature gauge needle in the upper zone can cause serious engine damage. Pull safely to the side of the road and allow engine temperature to return to normal.

 **Overheating** P. 631

*1: Models with the keyless access system have an **ENGINE START/STOP** button instead of an ignition switch.

Multi-Information Display

The multi-information display shows the odometer, trip meter, outside temperature indicator, and other gauges. It also displays important messages such as warnings and other helpful information.

Switching the Display

Main displays

Press the / (information) button to change the display.

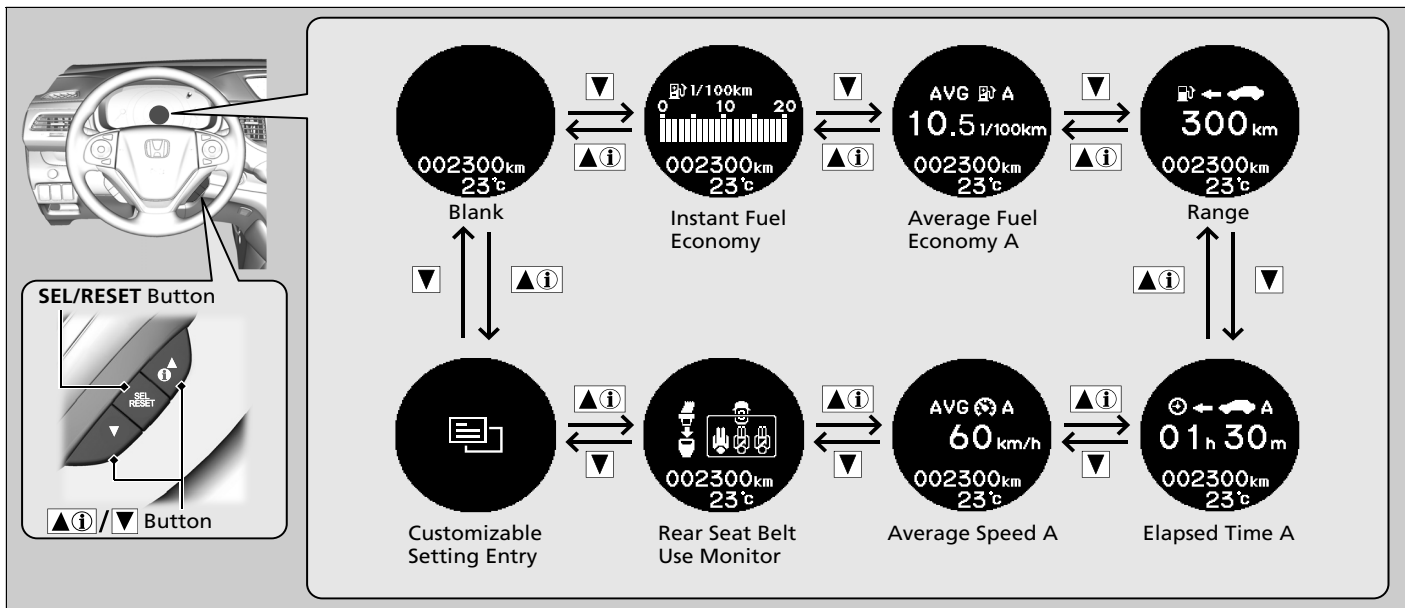

■ Lower displays

Press the **SEL/RESET** button to change the display.

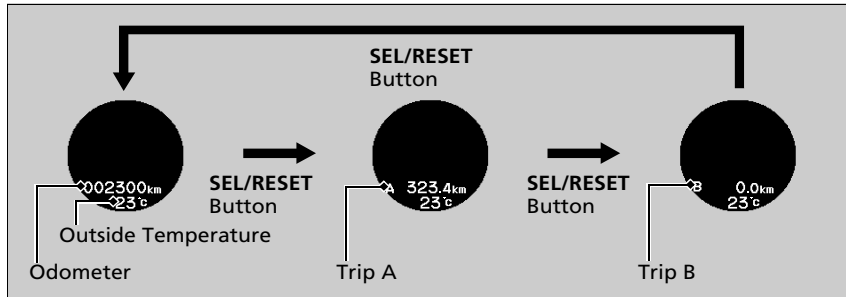

■ Odometer

Shows the total number of kilometres or miles that your vehicle has accumulated.

■ Trip Meter

Shows the total number of kilometres or miles driven since the last reset. Meters A and B can be used to measure two separate trips.

■ Resetting a trip meter

To reset a trip meter, display it, then press and hold the **SEL/RESET** button. The trip meter is reset to **0.0**.

►► Trip Meter

Switch between trip meter A and trip meter B by pressing the **SEL/RESET** button.

■ Outside Temperature

Shows the outside temperature in Celsius.

If the outside temperature has been below 3°C at the time you turn the ignition switch to ON ^{*1}, the outside temperature indicator blinks for 10 seconds.

■ Adjusting the outside temperature display

Adjust the temperature reading up to $\pm 3^{\circ}\text{C}$ if the temperature reading seems incorrect.

■ Instant Fuel Economy Gauge

Shows the instant fuel economy as a bar graph in l/100 km or mpg.

■ Average Fuel Economy

Shows the estimated average fuel economy of each trip meter in l/100 km or mpg. The display is updated at set intervals. When a trip meter is reset, the average fuel economy is also reset.

*1: Models with the keyless access system have an **ENGINE START/STOP** button instead of an ignition switch.

▶ Outside Temperature

The temperature sensor is in the front bumper. Road heat and exhaust from another vehicle can affect the temperature reading when your vehicle speed is less than 30 km/h (19 mph).

It may take several minutes for the display to be updated after the temperature reading has stabilized.

Use the multi-information display's customized features to correct the temperature.

▶ **Customized Features** P. 133

▶ Average Fuel Economy

You can change when to reset the average fuel economy.

▶ **Customized Features** P. 133

■ Range

Shows the estimated distance you can travel on the remaining fuel. This distance is estimated from the fuel economy of your previous trips.

■ Elapsed Time

Shows the time elapsed since Trip A or Trip B was reset.

■ Average Speed

Shows the average speed in km/h or mph since Trip A or Trip B was reset.

■ Rear Seat Belt Use Monitor

Shows the rear seat belt use.

➤ **Seat Belt Reminder** P. 41

⌘ Elapsed Time

You can change when to reset the elapsed time.

➤ **Customized Features** P. 133

⌘ Average Speed

You can change when to reset the average speed.

➤ **Customized Features** P. 133

■ Customized Features

Use the multi-information display to customize certain features.

■ How to customize

Select the  screen by pressing the  button while the ignition switch is in ON *, and the vehicle is at a complete stop. Select **CHANGE SETTINGS**, then press the **SEL/RESET** button.

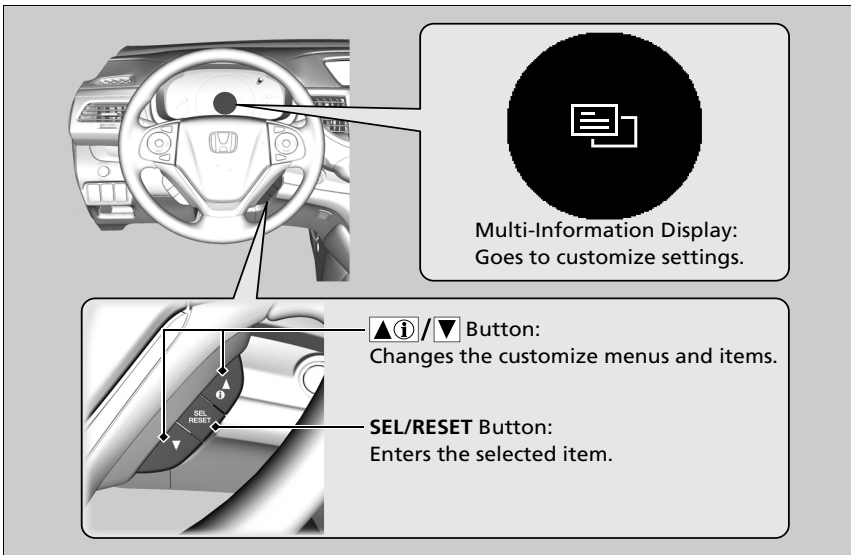

* 1: Models with the keyless access system have an **ENGINE START/STOP** button instead of an ignition switch.

▶ Customized Features

To customize other features, press the  button.

- ▶ **List of customizable options** P. 136
- ▶ **Example of customization settings** P. 141

When you customize settings:



Automatic transmission models

Change to **P**.

Manual transmission models

Set the parking brake.

■ Customization flow

Select the  screen by pressing the  button.

Instrument Panel

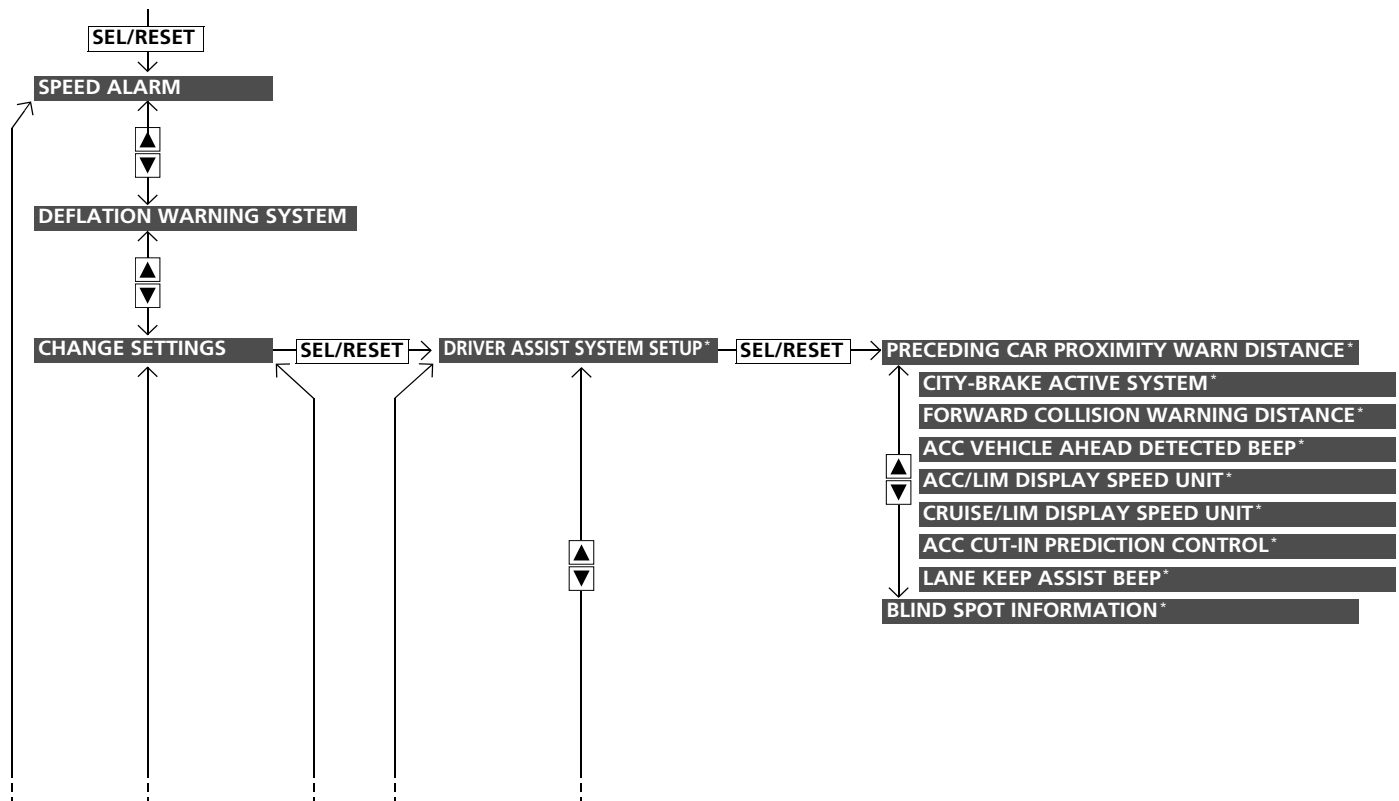

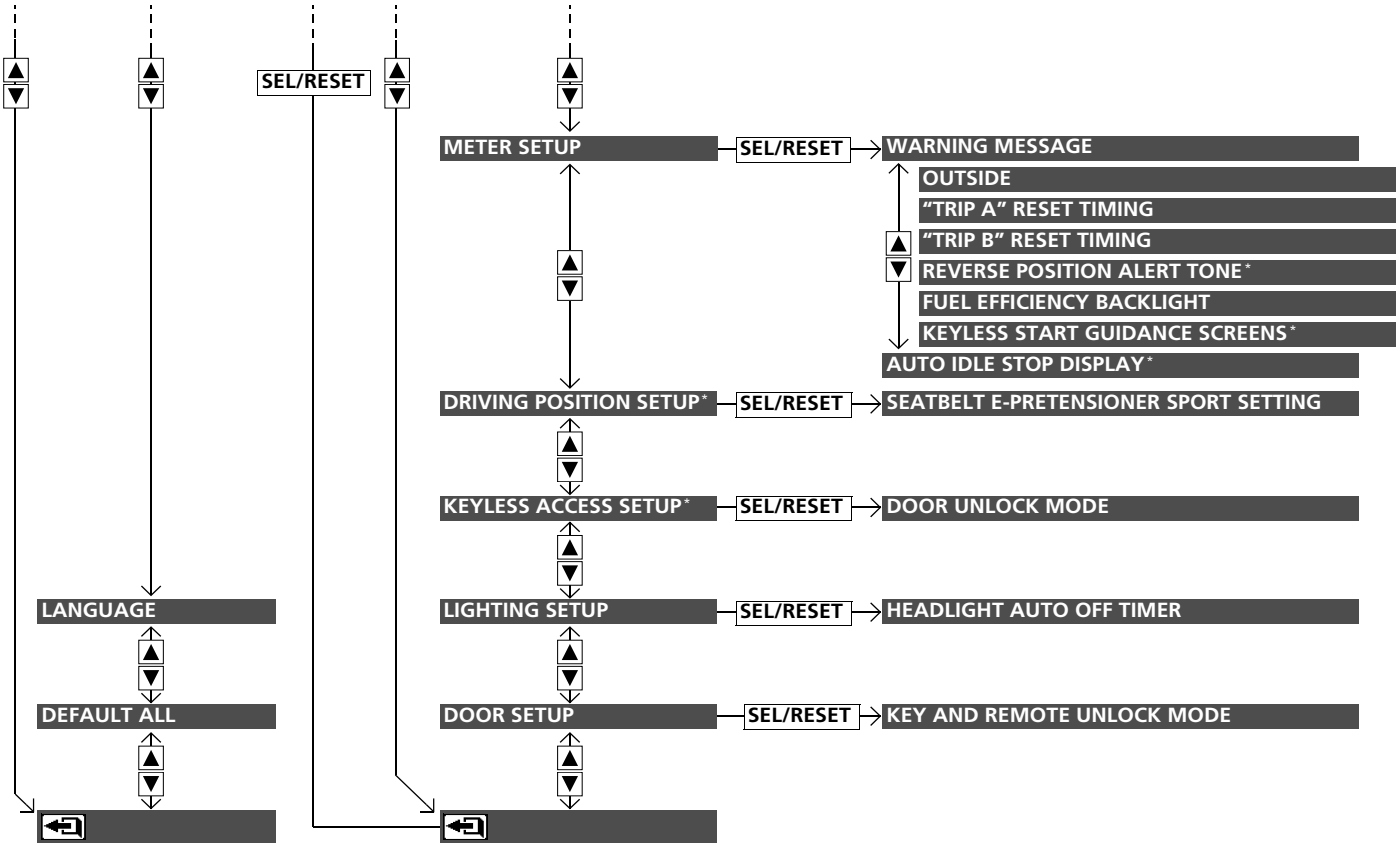





Instrument Panel

* Not available on all models

■ List of customizable options

Setup Group	Customizable Features	Description	Selectable settings
SPEED ALARM	<ul style="list-style-type: none"> • Sets the speed alarm to On at two stages, Speed alarm 1 and 2, separately. • Changes the speed setting of when the alarm goes off by 5 km/h or 5 mph accordingly at each stage. 		 (Speed alarm 1 ON)  (Speed alarm 1 OFF* ¹)
			Speed alarm 1 speed setting [50 km/h (30 mph)* ¹]
DEFLATION WARNING SYSTEM	Initialises the deflation warning system.		 (Speed alarm 2 ON)  (Speed alarm 2 OFF* ¹)
			Speed alarm 2 speed setting [80 km/h (50 mph)* ¹]
			CANCEL/INITIALISE

*1: Default Setting

Setup Group	Customizable Features	Description	Selectable settings	
CHANGE SETTINGS	DRIVER ASSIST SYSTEM SETUP*	PRECEDING CAR PROXIMITY WARN DISTANCE*	Changes the distance to activate the collision alert when a vehicle ahead of you gets too close.	FAR/NORMAL*¹/NEAR
		CITY-BRAKE ACTIVE SYSTEM*	Turns the City-Brake Active system feature on and off.	ON*¹/OFF
		FORWARD COLLISION WARNING DISTANCE*	Changes at which distance Forward Collision Warning or Collision Mitigation Braking System alerts, or turns Forward Collision Warning on and off.	FAR/NORMAL*¹/NEAR/OFF
		ACC VEHICLE AHEAD DETECTED BEEP*	Causes the system to beep when a vehicle ahead of you gets too close.	ON/OFF*¹
		ACC/LIM DISPLAY SPEED UNIT*	Changes the displayed measurement of the set vehicle speed on the multi-information display.	mph/km/h
		CRUISE/LIM DISPLAY SPEED UNIT*	Changes the displayed measurement of the set vehicle speed on the multi-information display.	mph/km/h

*1: Default Setting

* Not available on all models

Setup Group	Customizable Features	Description	Selectable settings	
CHANGE SETTINGS	DRIVER ASSIST SYSTEM SETUP*	ACC CUT-IN PREDICTION CONTROL*	Turns the ACC cut-in prediction control feature on and off.	ON*¹/OFF
		LANE KEEP ASSIST BEEP*	Causes the system to beep when the LKAS is suspended.	ON/OFF*¹
		BLIND SPOT INFORMATION*	Changes the setting for the blind spot information.	AUDIBLE AND VISUAL ALERT*¹/VISUAL ALERT ONLY/OFF

*1: Default Setting

Setup Group	Customizable Features	Description	Selectable settings	
CHANGE SETTINGS	METER SETUP	WARNING MESSAGE	Switches warning message to be displayed or not.	ON/OFF *1
		OUTSIDE	Adjusts the temperature reading by a few degrees.	-3°C ~ ±0°C*1 ~ +3°C
		“TRIP A” RESET TIMING	Changes the setting of how to reset trip meter A, average fuel economy A, average speed A, and elapsed time A.	WHEN REFUELED/ MANUAL RESET*1/ WHEN IGNITION IS TURNED OFF
		“TRIP B” RESET TIMING	Changes the setting of how to reset trip meter B, average fuel economy B, average speed B, and elapsed time B.	WHEN REFUELED/ MANUAL RESET*1/ WHEN IGNITION IS TURNED OFF
		REVERSE POSITION ALERT TONE*	Causes the beeper to sound once when the gear position is changed to R .	ON *1/ OFF
		FUEL EFFICIENCY BACKLIGHT	Turns the ambient meter feature on and off.	ON *1/ OFF
		KEYLESS START GUIDANCE SCREENS*	Displays the keyless start guidance when conditions are met to change power mode.	ON *1/ OFF
		AUTO IDLE STOP DISPLAY*	Selects whether the Auto Idle Stop display comes on or not.	ON *1/ OFF

*1: Default Setting

* Not available on all models

Setup Group	Customizable Features		Description	Selectable settings
CHANGE SETTINGS	DRIVING POSITION SETUP*	SEATBELT E-PRETENSIONER SPORT SETTING	Turns the seat belt e-pretensioner sport setting on and off.	ON*1/OFF
	KEYLESS ACCESS SETUP*	DOOR UNLOCK MODE	Changes which doors unlock when you grab the driver's door handle and tailgate handle. When you press the tailgate release button, if you chose DRIVER DOOR ONLY , only tailgate is unlatched. If you chose ALL DOORS , tailgate is unlatched and all doors are unlocked.	DRIVER DOOR ONLY*1/ ALL DOORS
	LIGHTING SETUP	HEADLIGHT AUTO OFF TIMER	Changes the length of time the exterior lights stay on after you close the driver's door.	60sec/30sec/15sec*1/0sec
	DOOR SETUP	KEY AND REMOTE UNLOCK MODE	Sets up either the driver's door or all doors to unlock on the first operation of the remote or ignition key.	DRIVER DOOR ONLY*1/ ALL DOORS
LANGUAGE			Changes the displayed language.	English*1/German/Italian/ French/Spanish/Polish/ Portuguese/Dutch/ Danish/Swedish/ Norwegian/Finnish/ Russian/Turkish*
DEFAULT ALL			Cancels/Resets all the customized settings as default.	CANCEL/OK

*1: Default Setting

* Not available on all models

■ Example of customization settings

The steps for changing the “TRIP A” RESET TIMING setting to **WHEN REFUELED** are shown below. The default setting for “TRIP A” RESET TIMING is **MANUAL RESET**.

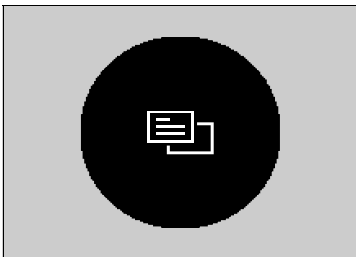



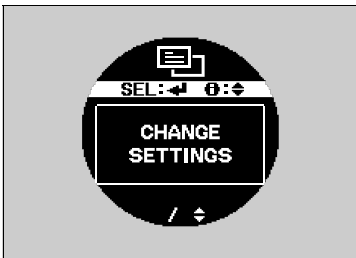



1. Press the /▼ button until appears on the display, then press the **SEL/RESET** button.

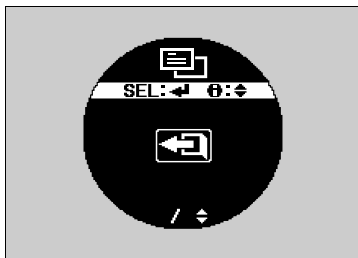

2. Press the /▼ button until **CHANGE SETTINGS** appears on the display, then press the **SEL/RESET** button.

3. Press the /▼ button until **METER SETUP** appears on the display, then press the **SEL/RESET** button.



4. Press the /▼ button until **"TRIP A" RESET TIMING** appears on the display, then press the **SEL/RESET** button.
 - The display switches to the customization setup screen, where you can select **WHEN REFUELED, MANUAL RESET, WHEN IGNITION IS TURNED OFF**, or .
5. Press the /▼ button and select **WHEN REFUELED**, then press the **SEL/RESET** button.
 - The **WHEN REFUELED** setup screen appears, then the display returns to the customization menu screen.
6. Press the /▼ button until  appears in the display, then press the **SEL/RESET** button.
7. Repeat Step 6 until you return to the normal screen.

i-Multi-Information Display

The i-multi-information display shows the fuel economy information, audio status, and clock.

Switching the Display

Press the  (display) button to change the display.

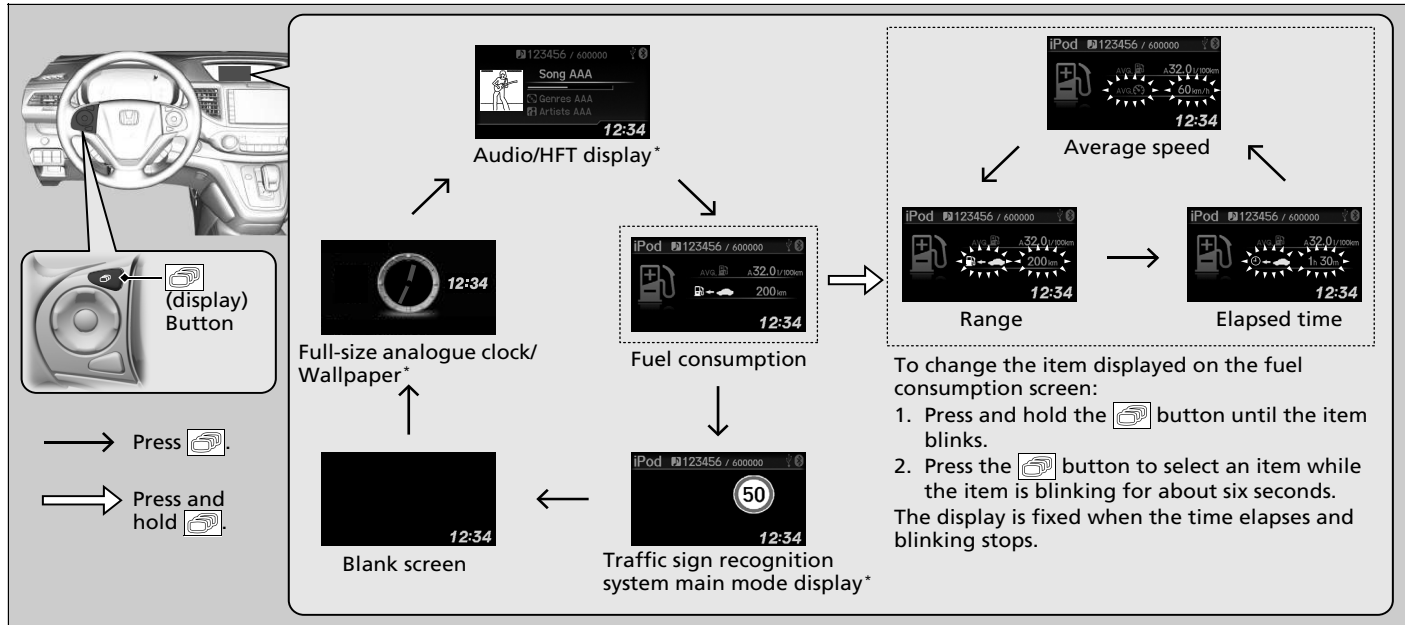

Instrument Panel

* Not available on all models

■ Average Fuel Economy

Shows the estimated average fuel economy of each trip meter in l/100 km or mpg. The display is updated at set intervals. When a trip meter is reset, the average fuel economy is also reset.

■ Range

Shows the estimated distance you can travel on the remaining fuel. This distance is estimated from the fuel economy of your previous trips.

■ Elapsed Time

Shows the time elapsed since Trip A or Trip B was reset.

■ Average Speed

Shows the average speed in km/h or mph since Trip A or Trip B was reset.

■ Turn-by-Turn Directions*

Shows you turn-by-turn driving directions to your destination linked with the navigation system.

➤ See the Navigation System Manual

☒ Switching the Display

You can choose an item to be displayed in the fuel consumption screen. Range, elapsed time, or average speed can be selected.

➤ Customized Features P. 145

➤ Switching the Display P. 143

☒ Average Fuel Economy

You can change when to reset the average fuel economy.

➤ Customized Features P. 145

☒ Range

You can choose an item to be displayed in the fuel consumption screen. Range, elapsed time, or average speed can be selected.

➤ Customized Features P. 145

☒ Elapsed Time

You can change when to reset the elapsed time.

➤ Customized Features P. 145

☒ Average Speed

You can change when to reset the average speed.

➤ Customized Features P. 145

☒ Turn-by-Turn Directions*

You can select whether the turn-by-turn display comes on or not during the route guidance.

➤ Customized Features P. 145

■ Customized Features

Use the i-multi-information display to customize certain features.

■ How to customize

Select the **Vehicle menu** screen by pressing the **MENU** button while the ignition switch is in ON *1, and the vehicle is at a complete stop. Select **Customise settings**, then press the **SOURCE** button.

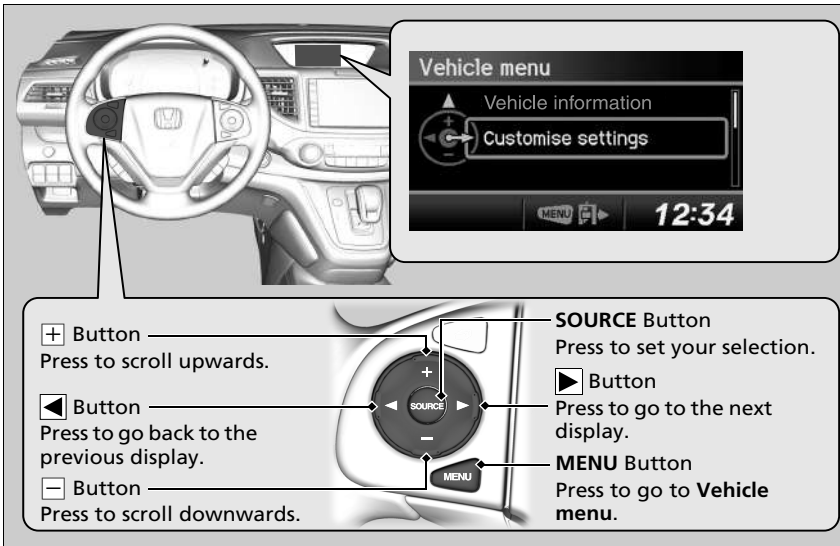



*1: Models with the keyless access system have an **ENGINE START/STOP** button instead of an ignition switch.

* Not available on all models

Continued

Customized Features

To customize other features, press the  /  button.

▶ **List of customizable options** P. 148

▶ **Example of customizing wallpapers*** P. 150

■ Customization flow

Press the **MENU** button.

Customized Features

You can exit the customizing screen at any time by pressing the **MENU** button.

Instrument Panel

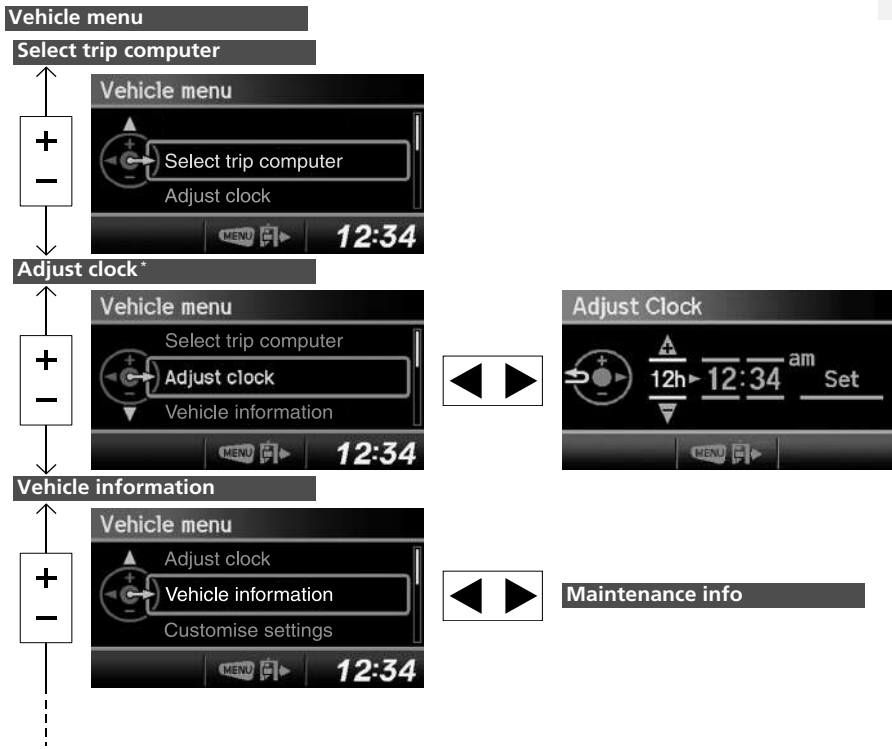

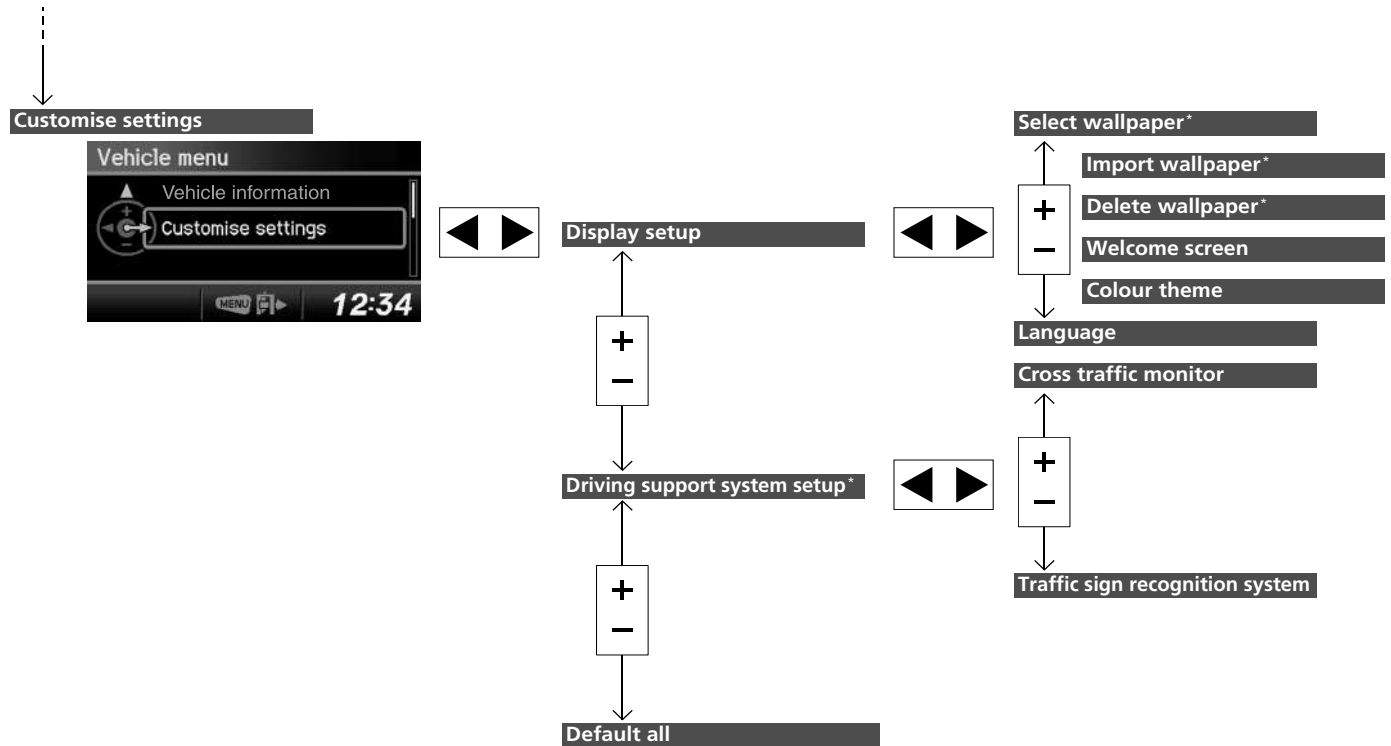

Instrument Panel

* Not available on all models

Continued

■ List of customizable options

Setup Group	Customizable Features	Description	Selectable settings
Select trip computer		Selects an item to be displayed along with instant fuel economy.	Range*¹/Elapsed time/ Average speed
Adjust clock*		Sets time display 12 hour or 24 hour and adjust the time.	12h*¹/24h
Vehicle information	Maintenance info	Reset the service reminder.	No/Yes
Customise settings	Display setup	Select wallpaper*	Selects the full-size analogue clock or the wallpaper. Clock*¹/Image 1/Image 2/ Image 3
		Import wallpaper*	Imports an image file for a new wallpaper. Three images can be stored. ▶ Importing Wallpapers from USB* P. 150
		Delete wallpaper*	Deletes an image file for a wallpaper. Image 1/Image 2/Image 3
		Welcome screen	Selects whether the welcome screen comes on or not when you turn the ignition switch to ON  ² . On*¹/Off

*1:Default Setting

*2:Models with the keyless access system have an **ENGINE START/STOP** button instead of an ignition switch.

Setup Group	Customizable Features	Description	Selectable settings
Customise settings	Colour theme	Changes the colour of the screen.	Blue^{*1}/Red/Amber/Grey
	Display setup		English^{*1}/German/Italian/French/Spanish/Polish/Portuguese/Dutch/Danish/Swedish/Norwegian/Finnish/Russian/Turkish/Czech/Hungarian/Slovene/Estonian/Latvian/Lithuanian
	Language	Changes the displayed language.	
	Driving support system setup*		
	Cross traffic monitor	Turns the cross traffic monitor feature on and off.	On^{*1}/Off
	Traffic sign recognition system	Selects whether the traffic sign small icons come on.	Small icons on^{*1}/Small icons off
	Default all	Cancels/Resets all the customized settings as default.	Cancel Reset all defaults

*1:Default Setting

* Not available on all models

■ Example of customizing wallpapers*

You can customize the display from clock to wallpaper.

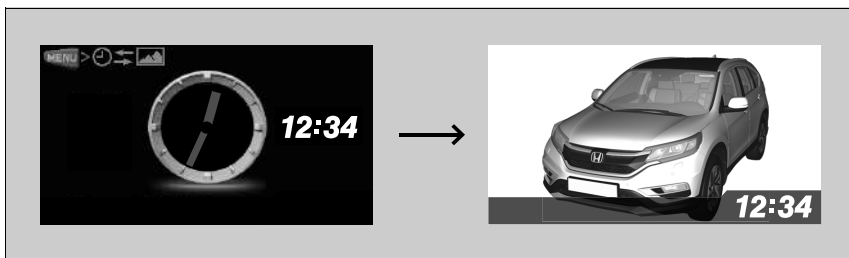

■ Importing Wallpapers from USB*

You can import up to three images, one at a time for wallpaper from a USB flash drive.

Select **Import wallpaper** from **Customise settings** and properly connect a USB flash drive to store an image.

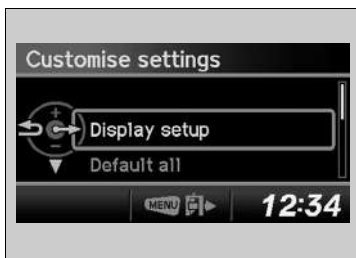

1. Connect the USB flash drive to the adapter cable.

➤ **USB Adapter Cable*** P. 241

2. Press the **MENU** button.
3. Select **Customise settings** with the $\boxed{+}$ / $\boxed{-}$ button, then press the **SOURCE** button.
4. Select **Display setup** with the $\boxed{+}$ / $\boxed{-}$ button, then press the **SOURCE** button.

☒ Customized Features

- When importing wallpaper files, the image must be in the USB flash drive's root directory. Images in a folder cannot be imported.
- The file format of the image that can be imported is BMP (bmp) or JPEG (jpg).
- Each image file can be up to 2 MB.
- The maximum image size is 1,920 x 936 pixels. If the image size was less than 480 x 234 pixels, the image is displayed in the middle of the screen with the extra area appearing in black.
- The number of files that can be selected is up to 255.
- Up to 64 characters can be displayed in the file name.



5. Select **Import wallpaper** with the $\left[\begin{smallmatrix} + \\ - \end{smallmatrix} \right]$ / $\left[\begin{smallmatrix} \leftarrow \\ \rightarrow \end{smallmatrix} \right]$ button, then press the **SOURCE** button.
 - ▶ The file names are displayed on the screen.



6. Press the $\left[\begin{smallmatrix} \leftarrow \\ \rightarrow \end{smallmatrix} \right]$ button until the file name you want to store appears on the centre of the display, then press the **SOURCE** button.



7. The preview of the imported data is displayed. Press the **SOURCE** button if it is OK.
8. Press the **SOURCE** button to save the image file.



9. Select the location you want to store the image file in with the \oplus / \ominus button, then press the **SOURCE** button.
10. Press the **MENU** button to exit the customize screen.

■ Selecting a Wallpaper



1. Press the **MENU** button.
2. Select **Customise settings** with the $\boxed{+}$ / $\boxed{-}$ button, then press the **SOURCE** button.
3. Select **Display setup** with the $\boxed{+}$ / $\boxed{-}$ button, then press the **SOURCE** button.
4. Select **Select wallpaper** with the $\boxed{+}$ / $\boxed{-}$ button, then press the **SOURCE** button.
5. Select the image file you want with the $\boxed{+}$ / $\boxed{-}$ button, then press the **SOURCE** button.
 - ▶ When the scroll is stopped, the thumbnail is displayed.
6. Press the **MENU** button to exit the customize screen.

Controls

This chapter explains how to operate the various controls necessary for driving.



Clock	156
Locking and Unlocking the Doors	
Key Types and Functions	158
Locking/Unlocking the Doors from the Outside.....	161
Locking/Unlocking the Doors from the Inside	167
Childproof Door Locks	168
Opening and Closing the Tailgate	169
Security System	
Immobilizer System	176
Security System Alarm *	176
Ultrasonic Sensors *	178
Super Locking *	179
Opening and Closing the Windows	180
Opening and Closing the Sunshade *	183

Operating the Switches Around the Steering Wheel	
Ignition Switch *	184
ENGINE START/STOP Button *	185
Ignition Switch and Power Mode Comparison	188
Turn Signals	189
Light Switches	189
Active Cornering Lights *	191
Fog Lights	192
Headlight Adjuster *	193
High Beam Support System *	194
Daytime Running Lights	196
Wipers and Washers	197
Brightness Control	201
Rear Demister/Heated Door Mirror Button	202
Driving Position Memory System *	203

Adjusting the Steering Wheel	205
Adjusting the Mirrors	
Interior Rearview Mirror	206
Power Door Mirrors	208
Adjusting the Seats	
Adjusting the Seat Positions	210
Interior Lights/Interior Convenience Items	
Interior Lights	220
Interior Convenience Items	222
Climate Control System	
Using Automatic Climate Control	234
Automatic Climate Control Sensors	238



* Not available on all models

Adjusting the Clock

You can adjust the time in the clock display with the ignition switch in ON *1.

Models without audio system









■ Using the MENU button

1. Press the **MENU** button.
2. Select **Adjust clock** with the  /  button, then press the **SOURCE** button.



Audio system with one display

■ Using the SETUP button

1. Press the **SETUP** button.
2. Rotate  to select **Adjust clock**, then press .
3. Rotate  to select the item you want to change (12/24 hour mode, hour, minute). Then press .
4. Rotate  to make the adjustment.
5. Press  to enter your selection. The display returns to **Adjust clock**. Repeat steps 4 to 6 to adjust other items.
6. To enter the selection, Rotate  and select **Set**, then press .
7. Press the **SETUP** button to go back to the normal display.

*1: Models with the keyless access system have an **ENGINE START/STOP** button instead of an ignition switch.

Adjusting the Clock

Models with navigation system

The clock is automatically updated through the navigation system, so the time does not need to be adjusted.

Audio system with one display

These indications are used to show how to operate the selector knob.





Rotate  to select.

Press  to enter.

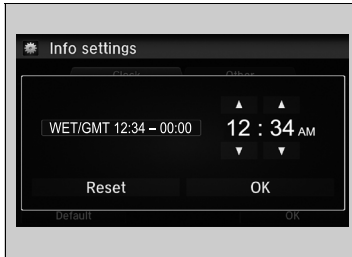
Audio system with two displays

■ Using the Settings menu on the audio/information screen



1. Press the  button.
2. Select **Settings**.
3. Select **Info**.
4. Select the **Clock** tab.
5. Select **Clock Adjustment**.
6. Select  or  to change hour.
7. Select  or  to change minute, then select **OK**.

▶ Using the Settings menu on the audio/information screen

You can customize the clock display to show the 12 hour clock or 24 hour clock.

▶ **Customized Features*** P. 323

The clock display is set to off by factory default. You can turn the clock display on and off.

▶ **Customized Features*** P. 323

* Not available on all models

Key Types and Functions

This vehicle comes with the following keys:

Keys

Retractable Key*



Keyless Remote*



Use the keys to start and stop the engine, and to lock and unlock all the doors and tailgate. You can also lock and unlock the doors and tailgate pressing the buttons on remote transmitter.

Key Types and Functions

All the keys have an immobilizer system. The immobilizer system helps to protect against vehicle theft.

Immobilizer System P. 176

The keys contain precision electronics. Adhere to the following advice to prevent damage to the electronics:

- Do not leave the keys in direct sunlight, or in locations with high temperature or high humidity.
- Do not drop the keys or set heavy objects on them.
- Keep the keys away from liquids.
- Do not take the keys apart except for replacing the battery.

If the circuits in the keys are damaged, the engine may not start, and the remote transmitter may not work.

If the keys do not work properly, have them inspected by a dealer.

■ **Keyless remote***

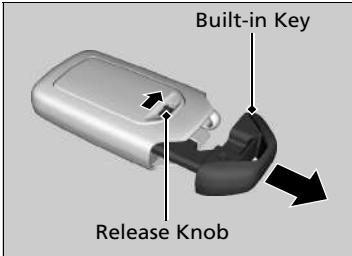

The built-in key can be used to lock the doors when the keyless remote battery becomes weak and the power door lock/unlock operation is disabled.

To remove the built-in key, pull it out while sliding the release knob. To reinstall the built-in key, push the built-in key into the keyless remote until it clicks.

■ **Retractable key***

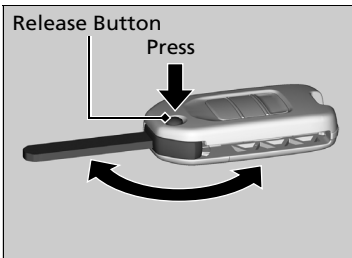

The key folds up inside the remote transmitter.

1. Press the release button to release the key out from the transmitter.
 - ▶ Make sure to fully extend the key.
2. To close the key, press the release button then push the key inside the transmitter until you hear a click.

▣ Keyless remote*

The seat automatically moves to the preset position when you unlock the door using the remote transmitter or keyless access system.

▣ **Driving Position Memory System*** P. 203

Always keep the built-in key inserted to keyless remote.

▣ Retractable key*

If the key is not fully extended, the immobilizer system may not work properly, and the engine may not start. Avoid contact with the key whenever it extends or retracts.

* Not available on all models

Continued

■ Key Number Tag

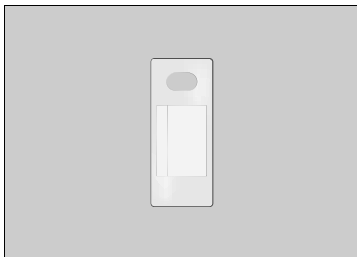

Contains a number that you will need if you purchase a replacement key.

▣ Key Number Tag

Keep the key number tag separate from the key in a safe place outside of your vehicle.

If you wish to purchase an additional key, contact a dealer.

If you lose your key and you cannot start the engine, contact a dealer.

Locking/Unlocking the Doors from the Outside

Using the Keyless Access System*

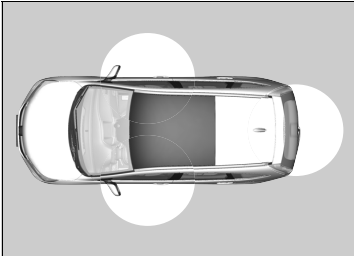

When you carry the keyless remote, you can lock/unlock the doors and open the tailgate.

You can lock/unlock the doors within a radius of about 80 cm (32 inches) of the outside door handle.

You can open the tailgate within about 80 cm (32 inches) radius from the tailgate release button.

Locking the doors and tailgate

Press the door lock button on the front door or the tailgate.

- ▶ Some exterior lights and indicators flash three times; all the doors and tailgate lock and the security system sets.

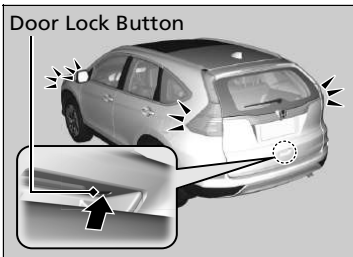
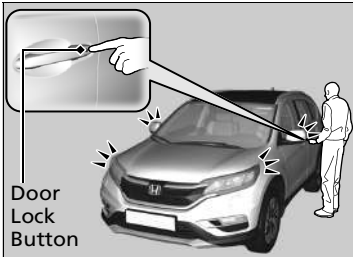

Locking/Unlocking the Doors from the Outside

Models with keyless access system

Right-hand drive type

You cannot lock any doors from the outside when the keyless remote is inside the vehicle, and the beeper sounds. If you want to lock a door while the remote is still in the vehicle, do any of the following four times:

- Press the lock button on the keyless remote.
- Turn the key in the cylinder to lock.
- Press the door lock button on the door handle or the tailgate.

Models with keyless access system

You can lock or unlock doors using the remote transmitter or keyless access system only when the power mode is in VEHICLE OFF.

Using the Keyless Access System*

- Do not leave the keyless remote in the vehicle when you get out. Carry it with you.
- Even if you are not carrying the keyless remote, you can lock/unlock the doors while someone else with the remote is within range.
- If you grip a front door handle wearing gloves, the door sensor may be slow to respond or may not respond by unlocking the doors.
- The door may be unlocked if the door handle is covered with water in heavy rain or in a carwash if the keyless remote is within range.

* Not available on all models

Continued



■ Unlocking the doors and tailgate

Grab the driver's door handle:

▶ The driver's door unlocks.

▶ Some exterior lights flash once.

Grab the front passenger's door handle:

▶ All the doors and tailgate unlock.

▶ Some exterior lights flash once.

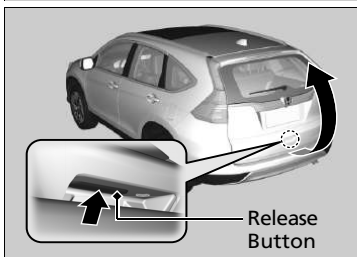

Press the tailgate release button:

▶ The tailgate unlocks.

▶ Some exterior lights flash once.

▣ Using the Keyless Access System *

- You cannot unlock the door by gripping the handle after two seconds of locking it.
- The door may not open if you pull it immediately after gripping the door handle. Grip the handle again and confirm that the door is unlocked before pulling the handle.
- Even within the 80 cm (32 inches) radius, you may not be able to lock/unlock the doors with the keyless remote if it is above or below the outside handle.
- The keyless remote may not operate if it is too close to the door and door glass.

If you do not open a door or the tailgate within 30 seconds of unlocking the vehicle, the doors will automatically relock.

You can customize the door unlock mode setting.

▣ **Customized Features** P. 133

■ Using the Remote Transmitter

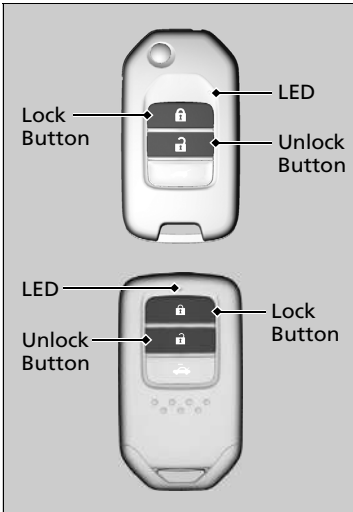

■ Locking the doors

Press the lock button.

- ▶ Some exterior lights flash three times, all the doors and tailgate lock, and the security system sets.

▣ Using the Remote Transmitter

If you do not open a door or the tailgate within 30 seconds of unlocking the vehicle with the remote transmitter, the doors will automatically relock.

If the interior light switch is in the door activated position, the interior lights come on when you press the unlock button.

No doors opened: The lights fade out after 30 seconds.

Doors relocked with the remote: The lights go off immediately.

▣ **Interior Lights** P. 220

■ Unlocking the doors

Press the unlock button.

Once:

- ▶ Some exterior lights flash once, and the driver's door unlocks.

Twice:

- ▶ The remaining doors and tailgate unlock.

🔗 Using the Remote Transmitter

The remote transmitter uses low-power signals, so the operating range may vary depending on the surroundings.

The remote transmitter will not work when the key is in the ignition switch. The remote will not lock the vehicle when a door or the tailgate is open.

If the distance at which the remote transmitter works varies, the battery is probably low.

If the LED does not come on when you press a button, the battery is dead.

🔗 **Replacing the Button Battery** P. 589, 590

You can customize the door unlock mode setting.

🔗 **Customized Features** P. 133

■ Locking/Unlocking the Doors Using a Key

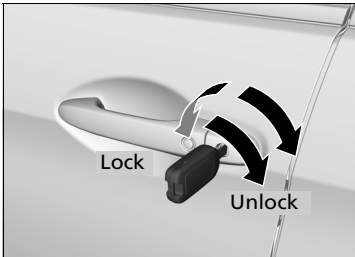

Fully insert the key and turn it.

■ Locking a Door Without Using a Key

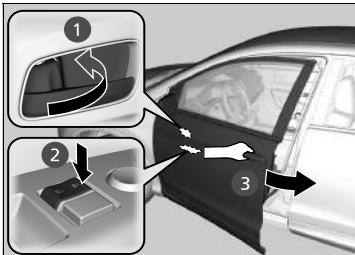

■ Locking the driver's door

Push the lock tab forward ① or push the master door lock switch in the lock direction ②, then pull and hold the outside door handle ③. Close the door, then release the handle.

■ Locking the passenger's doors

Push the lock tab forward and close the door.

■ Lockout prevention system

The doors and tailgate cannot be locked when the key is in the ignition switch*1, or the keyless remote is inside the vehicle.

*1: Models with the keyless access system have an **ENGINE START/STOP** button instead of an ignition switch.

▶ Locking/Unlocking the Doors Using a Key

When you lock the driver's door with the key, all the other doors and tailgate lock at the same time. You can customize the door unlock mode setting.

▶ **Customized Features** P. 133

Models without security system

When unlocking, the driver's door unlocks first. Turn the key a second time within a few seconds to unlock the remaining doors and the tailgate.

Models with security system

Unlocking the doors with the key causes the security system to alarm. Always unlock the doors and tailgate with the remote transmitter.

▶ Locking a Door Without Using a Key

When you lock the driver's door, all the other doors and tailgate lock at the same time. Make sure you have the key in your hand before locking the door to prevent it from being locked in the vehicle.

Low Keyless Remote Signal Strength*

The vehicle transmits radio waves to locate the keyless remote when locking/unlocking the doors, opening the tailgate, or to start the engine.

In the following cases, locking/unlocking the doors or opening the tailgate or starting the engine may be inhibited or operation may be unstable:

- Strong radio waves are being transmitted by nearby equipment.
- You are carrying the keyless remote together with telecommunications equipment, notebook computers, mobile phones, or wireless machines.
- A metallic object is touching or covering the keyless remote.

▣ Low Keyless Remote Signal Strength*

Communication between the keyless remote and the vehicle consumes the keyless remote battery. Battery life is about two years, but this varies depending on regularity of use.

The battery is consumed whenever the keyless remote is receiving strong radio waves. Avoid placing it near electrical appliances such as televisions and personal computers.

Locking/Unlocking the Doors from the Inside

Using the Lock Tab

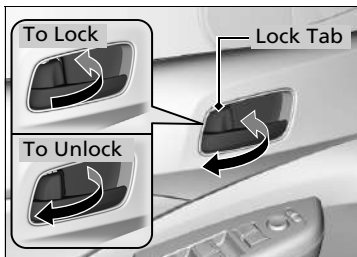

■ Locking a door

Push the lock tab forward.

■ Unlocking a door

Pull the lock tab rearward.

Unlocking Using the Front Door Inner Handle

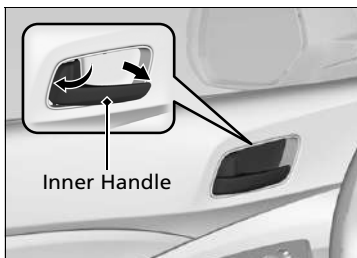

Pull the front door inner handle.

- ▶ The door unlocks and opens in one motion.

☒ Using the Lock Tab

When you lock the door using the lock tab on the driver's door, all the other doors and tailgate lock at the same time.

When you unlock the door using the lock tab on the driver's door, only the driver's door will unlock.

☒ Unlocking Using the Front Door Inner Handle

The inner front door handles are designed to allow front seat occupants to open the door in one motion. However this feature requires that front seat occupants never pull a front door inner handle while the vehicle is in motion.

Children should always ride in a rear seat where childproof door locks are provided.

☒ **Childproof Door Locks** P. 168

■ Using the Master Door Lock Switch

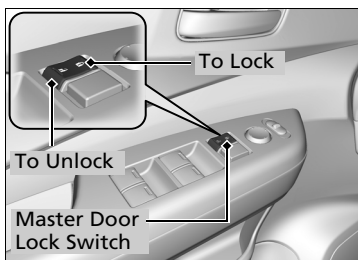

Press the master door lock switch in as shown to lock or unlock all doors and the tailgate.

Childproof Door Locks

The childproof door locks prevent the rear doors from being opened from the inside regardless of the position of the lock tab.

■ Setting the Childproof Door Locks

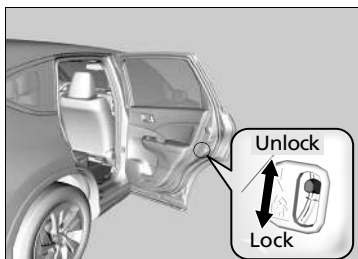

Slide the lever in the rear door to the lock position, and close the door.

■ When opening the door

Open the door using the outside door handle.

▣ Using the Master Door Lock Switch

When you lock/unlock the driver's door using the master door lock switch, all the other doors and tailgate lock/unlock at the same time.

▣ Childproof Door Locks

To open the door from the inside when the childproof door lock is on, put the lock tab in the unlock position, lower the rear window, put your hand out of the window, and pull the outside door handle.

Precautions for Opening/Closing the Tailgate

Always make sure individuals and objects are clear of the tailgate before opening or closing it.

■ Opening the tailgate

- Open the tailgate all the way.
 - ▶ If it is not fully opened, the tailgate may begin to close under its own weight.
- Be careful when it is windy. The wind may cause the tailgate to close.

■ Closing the tailgate

Keep the tailgate closed while driving to:

- ▶ Avoid possible damage.
- ▶ Prevent exhaust gas from leaking into the vehicle.
- ▶ **Carbon Monoxide Gas** P. 81

☒ Precautions for Opening/Closing the Tailgate

Be careful not to hit your head on the tailgate or to put your hands between the tailgate and the luggage area when closing the tailgate.

When you are storing or picking up luggage from the luggage area while the engine is idling, do not stand in front of the exhaust pipe. You may get burned.

Do not allow any passenger in the luggage space. They may get hurt during hard braking, a sudden acceleration, or a crash.

Using the Tailgate Release Button

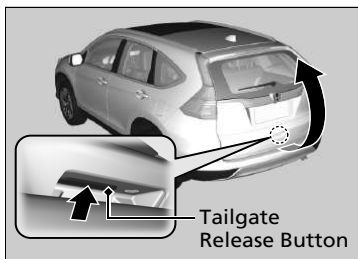

When all the doors are unlocked or press the tailgate unlock button on the remote transmitter, the tailgate is unlocked.

Models without power tailgate

Press the tailgate release button and lift open the tailgate.

Models with power tailgate

Press the tailgate release button for more than one second, and wait until you hear two beeps before you lift open the tailgate.

► Releasing the release button within one second with one beep enables the power tailgate operations.

► Opening/Closing the Power Tailgate*

P. 172

Models with keyless access system

If you are carrying the keyless remote, you do not have to unlock the tailgate before opening it.

►► Using the Tailgate Release Button

Models with keyless access system

- Do not leave the keyless remote in the vehicle when you get out. Carry it with you.
- Even if you are not carrying the keyless remote, you can unlock the tailgate while someone else with the remote is within range.

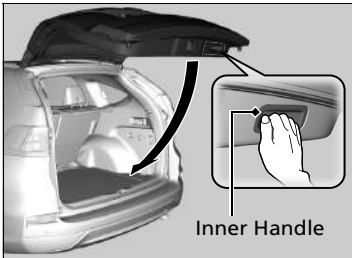

To close the tailgate, grab the inner handle, pull the tailgate down, and push it closed from outside.

If you close the tailgate when all the doors are locked, the tailgate locks automatically.

► Some exterior lights flash three times.

Models without power tailgate

Using the Remote Transmitter

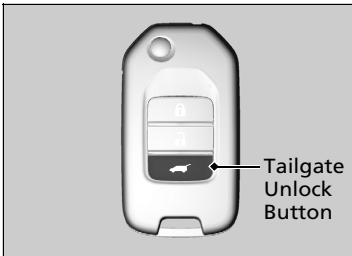

Press the tailgate unlock button to unlock the tailgate.

Using the Remote Transmitter

If you have unlocked and opened the tailgate using the remote transmitter, or keyless remote, when closing, the tailgate locks automatically.

Opening/Closing the Power Tailgate*

The power tailgate can be operated by pressing the power tailgate button on the remote transmitter, pressing the power tailgate button in the instrument panel, or pressing the button on the tailgate.

■ The power tailgate can be opened when:

- The tailgate is fully closed.
- The transmission is in **P** (automatic transmission).
- The parking brake is applied (manual transmission).

■ The power tailgate can be closed when:

- The tailgate is fully open.
- The transmission is in **P** (automatic transmission).
- The parking brake is applied (manual transmission).

► Opening/Closing the Power Tailgate*

⚠ WARNING

Opening or closing a power tailgate while any part of a passenger is in the tailgate's operating path can cause serious injury.

Make sure all passengers or objects are clear of the tailgate operating range before opening or closing the tailgate.

NOTICE

Do not push or pull on the power tailgate when it is being automatically opened or closed. Forcibly opening or closing the power tailgate while in operation can deform the tailgate frame.

When operating the power tailgate, make sure there is enough space around your vehicle. People near the tailgate may be seriously hurt if the tailgate hits or closes on their heads. Be especially cautious if children are around.

The power tailgate may not open or close under the following conditions:

- You start the engine while the tailgate is automatically opening or closing.
- The vehicle is parked on a steep hill.
- The vehicle is swayed in a strong wind.
- The tailgate or the roof is covered with snow or ice.

If you close the power tailgate when all the doors are locked, the power tailgate locks automatically.

Remote Transmitter

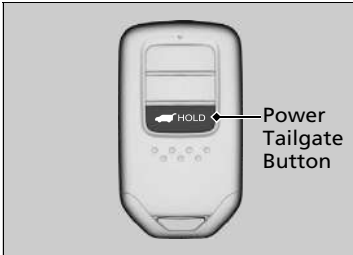

To open or close the power tailgate, do the following:

Press the power tailgate button for more than one second to operate.

- ▶ Some exterior lights flash.

To reverse direction while the power tailgate is in operation, press the button again.

Opening/Closing the Power Tailgate*

If you close the power tailgate when all the doors are locked, the power tailgate locks automatically and some exterior lights flash three times.

If you replace the battery or the power tailgate fuse while the tailgate is open, the power tailgate may be disabled. The power tailgate resumes once you manually close the tailgate.

Installing aftermarket components other than genuine Honda accessories on the power tailgate may prevent it from fully opening or closing.

Make sure the power tailgate is fully open before you get your luggage in and out.

Make sure the power tailgate is fully closed before you start the vehicle.

The beeper sounds when you start driving while the power tailgate is still open, or closing.

* Not available on all models

■ Power Tailgate Button

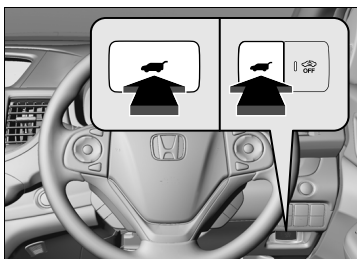

To open: Press and hold the tailgate button in the driver side control panel for about one second.

▶ Some exterior lights flash.

To close: Press and hold the tailgate button in the driver side control panel for about one second.

▶ Some exterior lights flash.

To reverse direction while the power tailgate is in operation, press the button again.

■ Power Tailgate Close Button

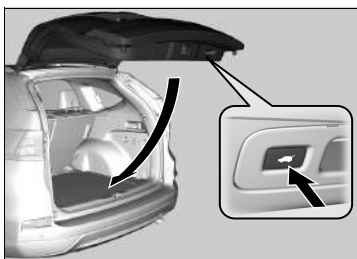

Press the button on the tailgate to close the power tailgate.

If you press the button again while the power tailgate is closing, it stops and reverses direction.

⌘ Opening/Closing the Power Tailgate*

If the power tailgate meets resistance while opening or closing, the auto reverse feature reverses the direction. The beeper sounds three times.

The auto reverse function stops sensing when the tailgate is almost closed to make sure that it fully closes.

Do not touch the sensors located on both sides of the tailgate. The power tailgate does not close if you touch either sensor when you are trying to close the tailgate.

Be careful not to scratch the sensors with a sharp object. If scratched, they can be damaged, and the power tailgate closing feature malfunctions.

⌘ Power Tailgate Close Button

If you press the tailgate release button inside the handle while the tailgate is automatically opening or closing, the power tailgate operation stops. Use caution if the tailgate stops in the middle of either operation. It may suddenly swing up or down.

■ Auto-Closer

If you manually close the power tailgate, it latches automatically.

■ Power Tailgate Fall Detection

Automatically lowers the power tailgate when there is a possibility that the fully opened power tailgate can fall down by its own weight (for example, by snow on the tailgate). The beeper sounds while the power tailgate lowers.

☒ Auto-Closer

The auto-closer feature does not activate if you push the tailgate open button while the power tailgate is closing.

Do not put any force on the tailgate while the power tailgate is latching.

Keep your hands away from the tailgate when you manually close the tailgate and let it latch automatically. It is dangerous to put your hands around the tailgate as it starts to latch itself.

☒ Power Tailgate Fall Detection

If you try to manually close the power tailgate immediately after it fully opens, the power tailgate fall detection may activate.

Once the power tailgate fall detection activates, wait until the power tailgate fully closes. Keep away from the power tailgate when it is in motion.

If the power tailgate fall detection constantly activates, consult a dealer.

Immobilizer System

The immobilizer system prevents a key that has not been pre-registered from starting the engine. Each key contains electronic transmitters that use electronic signals to verify the key.

Pay attention to the following when inserting the key into the ignition switch or pressing the **ENGINE START/STOP** button*:

- Do not allow objects that emit strong radio waves near the ignition switch*1.
- Make sure the key is not covered by or touching a metal object.
- Do not bring a key from another vehicle's immobilizer system near the ignition switch or keyless remote.

Security System Alarm *

The security system alarm activates when the tailgate, bonnet, or doors are opened without the remote transmitter or keyless remote. It also activates if you unlock the door with the key.

■ When the security system alarm activates

The horn sounds intermittently, and some exterior lights flash.

■ To deactivate the security system alarm

Unlock the vehicle using the remote transmitter, keyless access system, or the ignition switch is turned to ON **II***1. The system, along with the horn and flashing lights, is deactivated.

*1: Models with the keyless access system have an **ENGINE START/STOP** button instead of an ignition switch.

* Not available on all models

» Immobilizer System

NOTICE

Leaving the ignition key in the vehicle can result in theft or accidental movement of the vehicle. Always take the ignition key with you whenever you leave the vehicle unattended.

If the system repeatedly does not recognize the coding of your key, contact your dealer. If you have lost your key and cannot start your engine, contact a dealer.

Do not alter the system or add other devices to it. Doing so may damage the system and make your vehicle inoperable.

» Security System Alarm *

The security alarm continues for 30 seconds, then the system resets. If the cause of the alarm continues, alarming will repeat several times at about 5 second intervals.

■ Setting the security system alarm

The security system alarm automatically sets when the following conditions have been met:

- The ignition switch is in LOCK **[0]**^{*1}, and the key has been removed from the ignition switch.
- The bonnet is closed.
- All doors and the tailgate are locked with the key, remote transmitter, or keyless access system.

■ When the security system alarm sets

The security system alarm indicator in the instrument panel blinks. When the blinking interval changes after about 15 seconds, the security system alarm is set.

■ To cancel the security system alarm

The security system alarm is cancelled when the vehicle is unlocked using the remote transmitter or keyless access system, or the ignition switch is turned to ON **[II]**^{*1}. The security system alarm indicator goes off at the same time.

*1: Models with the keyless access system have an **ENGINE START/STOP** button instead of an ignition switch.

* Not available on all models

☒ Security System Alarm*

Do not set the security system alarm when someone is in the vehicle or a window is open. The system can accidentally activate when unlocking the door with the lock tab.

If the battery goes dead after you have set the security system alarm, the security alarm may go off once the battery is recharged or replaced. If this occurs, deactivate the security system alarm by unlocking a door using the remote transmitter or keyless access system.

Do not attempt to alter this system or add another device to it.

Do not unlock the door using the key. The security system alarm goes off.



Ultrasonic Sensors*

The ultrasonic sensors activate only when the security system alarm sets. The sensors detect if someone intrudes into the passenger compartment through a window or moves in the compartment, and activate the alarm.

■ To set the security system alarm without activating the ultrasonic sensors

You can set the security system alarm without activating the ultrasonic sensor.



To turn off the ultrasonic sensor system, press the ultrasonic sensor OFF button after you remove the key from the ignition switch, or with the key in the ACCESSORY  or LOCK *1.

⊗ Ultrasonic Sensors*

Do not set the security system alarm while someone is in the vehicle, or if a window is open. The system may accidentally activate when the ultrasonic sensor detects vibrations or loud sounds.

Do not unlock the door using the key. The security system alarm goes off.

*1: Models with the keyless access system have an **ENGINE START/STOP** button instead of an ignition switch.

* Not available on all models

Super Locking*

The super locking function disables the lock tabs on all doors.

■ To activate the super locking function

- Turn the key in the driver's door towards the vehicle front twice within five seconds.
- Press the lock button on the remote transmitter or keyless remote twice within five seconds.

Models with keyless access system

- Press the door lock button on the door handle or the tailgate twice within five seconds.

■ To cancel the super locking function

- Unlock the driver's door with the remote transmitter, keyless remote, or the ignition switch is turned to ON *1.

*1: Models with the keyless access system have an **ENGINE START/STOP** button instead of an ignition switch.

* Not available on all models

Super Locking*

⚠ WARNING

No one must be inside the vehicle with the super locking set. Persons locked in can get seriously sick or die from the heat built inside the vehicle if left in the sun.

Make sure there is no one inside the vehicle before setting the super locking.

Do not unlock the door using the key. The security system alarm goes off.

Even if you have unlocked and opened the tailgate, then closed it, the super locking function continues to be in effect.

Opening/Closing the Power Windows

The power windows can be opened and closed when the ignition switch is in ON ^{*1}, using the switches on the doors. The driver's side switches can be used to open and close all the windows.

The power window lock button on the driver's side must be switched off (not pushed in, indicator off) to open and close the windows from anywhere other than the driver's seat.

When the power window lock button is switched on (pushed in, indicator on), you can only operate the driver's window. Turn the power window lock button on if a child is in the vehicle.

Opening/Closing Windows with Auto-Open/Close Function

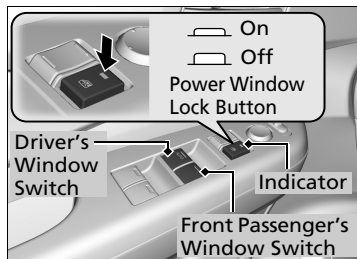

Automatic operation

To open: Push the switch down firmly.

To close: Pull the switch up firmly.

The window opens or closes completely. To stop the window at any time, push or pull the switch briefly.

Manual operation

To open: Push the switch down lightly, and hold it until the desired position is reached.

To close: Pull the switch up lightly, and hold it until the desired position is reached.

*1: Models with the keyless access system have an **ENGINE START/STOP** button instead of an ignition switch.

Opening/Closing the Power Windows

WARNING

Closing a power window on someone's hands or fingers can cause serious injury.

Make sure your passengers are away from the windows before closing them.

WARNING: Always take the ignition key with you whenever you leave the vehicle alone (with other occupants).

The power windows can be operated for up to 10 minutes after you turn the ignition switch to off^{*1}.

Auto-open/close function on front windows

Opening either front door cancels this function.

Auto-open/close function on all windows

Closing the driver's door cancels this function.

Auto Reverse

If a power window senses resistance when closing automatically, it stops closing and reverse direction.

The driver's window auto reverse function is disabled when you continuously pull up the switch.

The auto reverse function stops sensing when the window is almost closed to ensure that it fully closes.

■ Opening/Closing Windows without Auto-Open/Close Function *

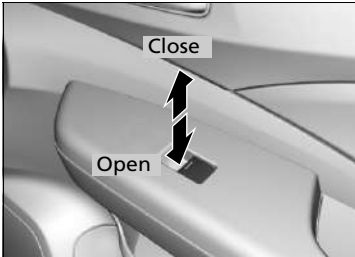

To open: Push the switch down.
To close: Pull the switch up.

Release the switch when the window reaches the desired position.

■ Opening/Closing Windows with the Remote *

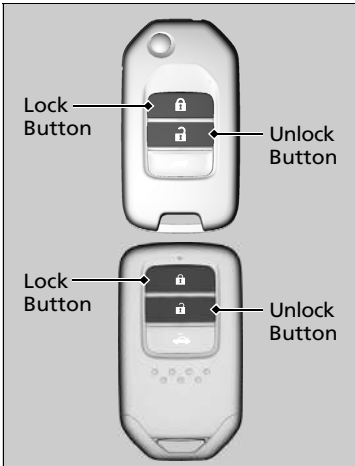

To open: Press the unlock button twice within 10 seconds and hold it down the second time.

To close: Press the lock button twice within 10 seconds and hold it down the second time.

If the windows stop midway, repeat the procedure.

* Not available on all models

Continued

■ Closing Windows with the Key*

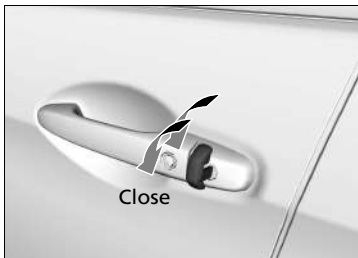

To close: Lock the driver's door with the key. Within 10 seconds of returning the key to the central position, turn the key in the lock direction and hold it there.

If the windows stop midway, repeat the procedure.

☒ Closing Windows with the Key*

Do not unlock the door using the key. The security system alarm goes off.

Opening/Closing the Sunshade

You can only operate the sunshade when the power mode is in ON. Use the switch in the front of the ceiling to open and close the sunshade.

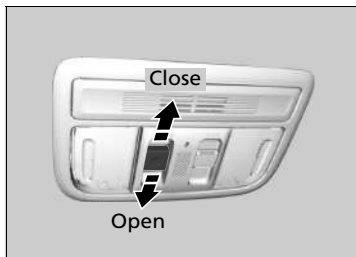

Automatic operation

To open: Push the switch forward firmly.

To close: Pull the switch back firmly.

The sunshade automatically opens or closes all the way. To stop the sunshade midway, touch the switch briefly.

Manual operation

To open: Push the switch forward lightly, and hold it until the desired position is reached.

To close: Pull the switch back lightly, and hold it until the desired position is reached.

Opening/Closing the Sunshade

⚠ WARNING

Opening or closing the sunshade on someone's hands or fingers can cause serious injury.

Make sure all hands and fingers are clear of the sunshade before opening or closing it.

WARNING: Always take the ignition key with you whenever you leave the vehicle alone (with other occupants).

The power sunshade can be operated for up to 10 minutes after you set the power mode to VEHICLE OFF.

Closing the driver's door cancels this function.

When resistance is detected, the auto reverse function causes the sunshade to change directions, then stop. Auto reverse stops sensing when the sunshade is almost closed to ensure that it fully closes.

* Not available on all models

Ignition Switch *

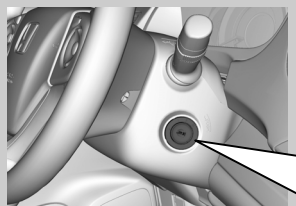

- 0** LOCK: Insert and remove the key in this position.
- I** ACCESSORY: Operate the audio system and other accessories in this position.
- II** ON: This is the position when driving.
- III** START: This position is for starting the engine. The switch returns to ON **II** when you let go of the key.

Ignition Switch *

Manual transmission models

WARNING

Removing the key from the ignition switch while driving locks the steering. This can cause you to lose control of the vehicle.

Remove the key from the ignition switch only when parked.

Automatic transmission models

You cannot take the key out unless the transmission is in **P**.

All models

If you open the driver's door when the key is in LOCK **0** or ACCESSORY **I**, the following messages appear on the multi-information display:

- In LOCK **0**: 
- In ACCESSORY **I**: 

If the key won't turn from LOCK **0** to ACCESSORY **I**, turn the key while moving the steering wheel left and right. The steering wheel will unlock, allowing the key to turn.

ENGINE START/STOP Button*

Changing the Power Mode

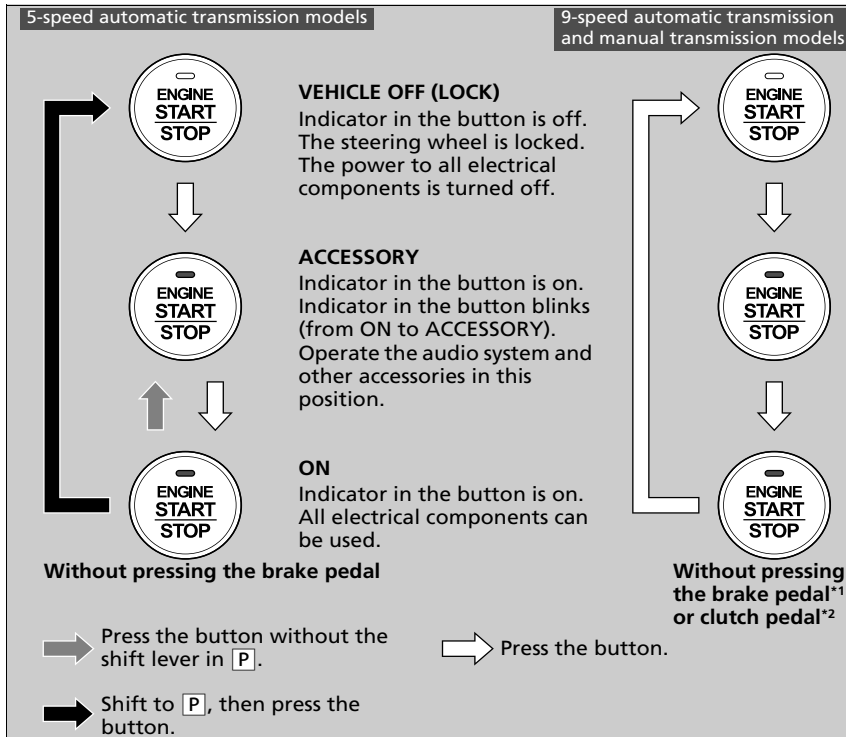

*1:9-speed automatic transmission models

*2:Manual transmission models

* Not available on all models

Continued

ENGINE START/STOP Button*

ENGINE START/STOP Button Operating Range

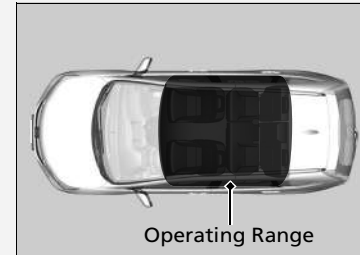

You can start the engine when the keyless remote is inside the vehicle.
 The engine may also run if the keyless remote is close to the door or window, even if it is outside the vehicle.

ON mode:
 Indicator in the button is off, if the engine is running.

If the keyless remote battery is weak, beeper sounds and  appears on the multi-information display.

▶ If the Keyless Remote Battery is Weak
 P. 623

Do not leave the power mode in ACCESSORY or ON when you get out.

■ Automatic Power Off

If you leave the vehicle for 30 to 60 minutes with the transmission in **P** and the power mode in ACCESSORY, the vehicle automatically goes into the mode similar to VEHICLE OFF to avoid the battery drain.

When in this mode:

The steering wheel does not lock.

You cannot lock or unlock doors with the remote transmitter or the keyless access system.

Press the **ENGINE START/STOP** button to switch the mode to VEHICLE OFF.

■ Power Mode Reminder

If you open the driver's door when the power mode is set to ACCESSORY, a warning buzzer sounds.

■ Keyless Remote Reminder

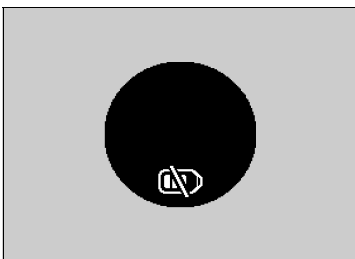

Warning buzzers may sound from inside or/ and outside the vehicle to remind you that the keyless remote is out of the vehicle. If the buzzer continues even after the remote is put back inside, place it within its operational range.

■ When the power mode is in ON

If the keyless remote is taken out of the vehicle, and the all doors are closed, warning buzzers sound from both inside and outside the vehicle. A warning message on the multi-information display notifies the driver inside that the remote is out.

■ When the power mode is in ACCESSORY

If the keyless remote is taken out of the vehicle, and the all doors are closed, a warning buzzer sounds from outside the vehicle.

▣ Keyless Remote Reminder









When the keyless remote is within the system's operational range, and the driver's door is closed, the warning function cancels.

If the keyless remote is taken out of the vehicle after the engine has been started, you can no longer change the **ENGINE START/STOP** button mode or restart the engine. Always make sure if the remote is in your vehicle when you operate the **ENGINE START/STOP** button.

Removing the keyless remote from the vehicle through a window does not activate the warning buzzer.

Do not put the keyless remote on the dashboard or in the glove box. It may cause the warning buzzer to go off. Under some other conditions that can prevent the vehicle from locating the remote, the warning buzzer may also go off even if the remote is within the system's operational range.

Ignition Switch and Power Mode Comparison

Ignition Switch Position	LOCK (0) (with/without the key) 	ACCESSORY (I) 	ON (II) 	START (III) 
Without Keyless Access System	<ul style="list-style-type: none"> • Engine is turned off and power is shut down. • The steering wheel is locked. • No electrical components can be used. 	<ul style="list-style-type: none"> • Engine is turned off. • Some electrical components such as the audio system and the accessory power can be operated. 	<ul style="list-style-type: none"> • Normal key position while driving. • All electrical components can be used. 	<ul style="list-style-type: none"> • Use this position to start the engine. • The ignition switch returns to the ON (II) position when you release the key.
Power Mode	VEHICLE OFF (LOCK) 	ACCESSORY 	ON Indicator is:  On  Off	START 
With Keyless Access System and ENGINE START/STOP Button	Indicator-Off <ul style="list-style-type: none"> • Engine is turned off and power is shut down. • The steering wheel is locked. • No electrical components can be used. 	Indicator-On or blinking <ul style="list-style-type: none"> • Engine is turned off. • Some electrical components such as the audio system and the accessory power can be operated. 	Indicator-On (engine is turned off) Off (engine is running) <ul style="list-style-type: none"> • All electrical components can be used. 	Indicator-Off <ul style="list-style-type: none"> • The mode automatically returns to ON after the engine starts.

Turn Signals

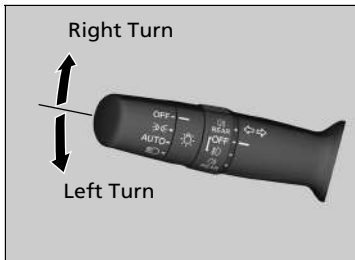

The turn signals can be used when the ignition switch is in ON *1.

■ One-push turn signal

When you lightly push up or down and release the turn signal lever, the exterior turn signals and turn signal indicator blink three times.

This feature can be used when signalling for a lane change.

Light Switches

■ Manual Operation

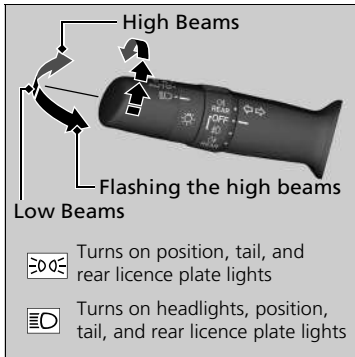

Rotating the light switch turns the lights on and off, regardless of the position of the ignition switch*1.

■ High beams

Push the lever forward until you hear a click.

■ Low beams

When in high beams, pull the lever back to return to low beams.

■ Flashing the high beams

Pull the lever back, and release it.

*1: Models with the keyless access system have an **ENGINE START/STOP** button instead of an ignition switch.

▶ Light Switches

If you remove the key from the ignition switch while the lights are on, a light on reminder chime sounds when you open the driver's door.

Models with high voltage discharge tube bulbs

Repeatedly turning the headlights on and off reduces the life of the HID headlight bulbs. If you sense that the level of the headlights is abnormal, have the vehicle inspected by a dealer.

Do not leave the lights on when the engine is off because it will cause the battery to discharge.

Automatic Lighting Control*

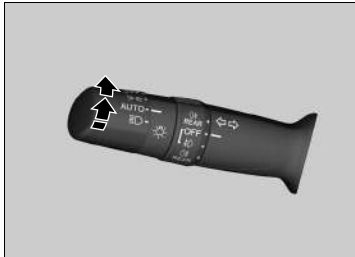

Automatic lighting control can be used when the ignition switch is in ON *1.

When you turn the light switch to **AUTO**, the headlights and other exterior lights will switch on and off automatically depending on the ambient brightness.

Automatic Lighting Off Feature

The headlights, all other exterior lights, and the instrument panel lights turn off 15 seconds after you remove the key or set the power mode to VEHICLE OFF (LOCK), take the remote with you, and close the driver's door. However, when the switch is in , the parking lights remain on.

If you turn the ignition switch to LOCK *1 with the headlight switch on, but do not open the door, the lights turn off after 10 minutes (three minutes, if the switch is in the **AUTO*** position).

The lights turn on again when you unlock or open the driver's door. If you unlock the door, but do not open it within 15 seconds, the lights go off. If you open the driver's door, you will hear a lights on reminder chime.

*1: Models with the keyless access system have an **ENGINE START/STOP** button instead of an ignition switch.

* Not available on all models

Automatic Lighting Control*

We recommend that you turn on the lights manually when driving at night, in a dense fog, or in dark areas such as long tunnels or parking facilities.

The light sensor is in the location shown below. Do not cover this light sensor with anything; otherwise, the automatic lighting system may not work properly.

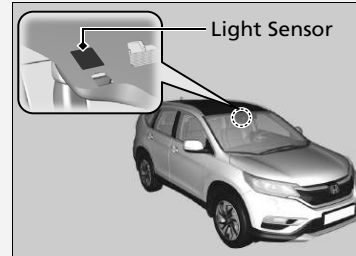

Active Cornering Lights*

Enhance the visibility of the corner(s) when making a turn. With the ignition switch in ON [II]*1, the headlights on, and the vehicle speed at less than 40 km/h (25 mph), the cornering light(s) comes on either when operating the turn signals or the steering wheel, or select [R].

■ **The corner you are making a turn towards is illuminated when:**

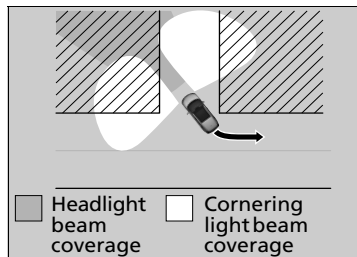
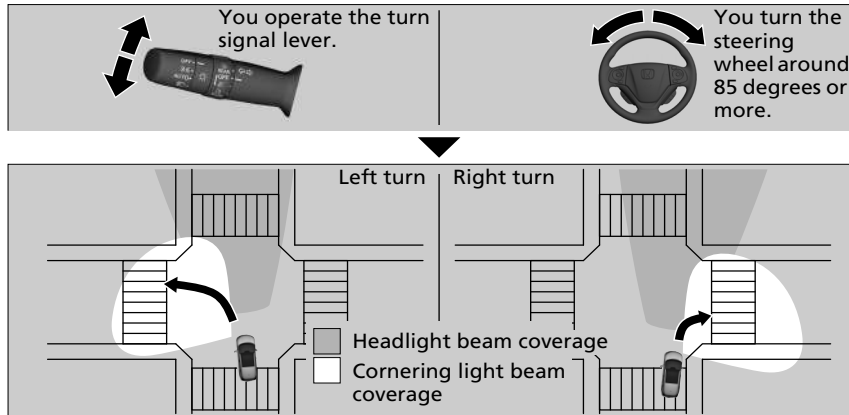

■ **Both front corners are illuminated when:**

You select [R].

*1: Models with the keyless access system have an **ENGINE START/STOP** button instead of an ignition switch.

* Not available on all models

Active Cornering Lights*

The active cornering lights turn off automatically after five minutes. To turn the lights back on, recreate the condition that has triggered the lights to come on for the first time. If the lights came on when you moved the turn signal lever, return the lever, then move it again. If it was the steering wheel, turn it to the central position, and steer again. Or, if it was the shift lever, momentarily move it to another position other than [R].

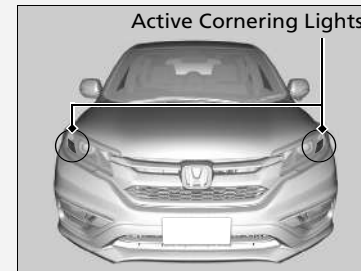

Fog Lights

■ Front fog lights*

Can be used when the position lights or the headlights are on.

■ Rear fog light

Can be used when the headlights or the front fog lights are on.

■ Front and Rear Fog Lights*

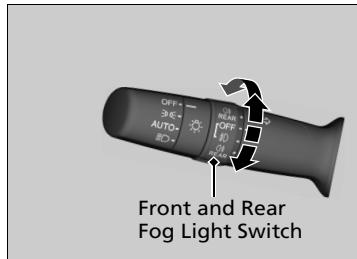

■ To turn the front fog lights on

Rotate the switch up from the **OFF** position to the ☀ position. The ☀ indicator comes on.

■ To turn the front and rear fog lights on

Rotate the switch one position up from the ☀ position. The ☀ and ☁ indicators come on.

■ To turn the rear fog light on

Rotate the switch down from the **OFF** position. The ☁ indicator comes on.

■ Rear Fog Light

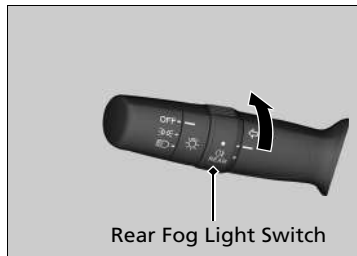

■ To turn the rear fog light on

Rotate the switch to ☁. The ☁ indicator comes on.

Headlight Adjuster*

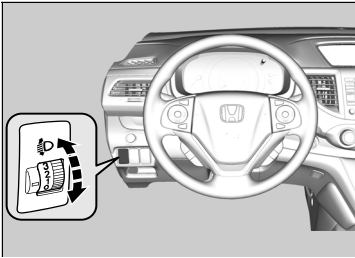

You can adjust the vertical angle of the low beam headlights when the ignition switch is in ON **II**.

The larger dial number indicates the lower angle.

■ To select the adjusting dial position

Refer to the below table for the appropriate dial position for your vehicle's riding and loading conditions.

Condition	Dial position
A driver	0
A driver and a front passenger	0
Five persons in the front and rear seats	1
Five persons in the front and rear seats and luggage in the luggage area, within the limit of maximum permissible axle weight and maximum permissible vehicle weight	2
A driver and luggage in the luggage area, within the limits of maximum permissible axle weight and maximum permissible vehicle weight	3

▣ Headlight Adjuster*

▣ Models with high voltage discharge tube bulbs

Your vehicle is equipped with the automatic headlight adjusting system that automatically adjusts the vertical angle of the low beam headlights. If you find a significant change in the vertical angle of the headlights, there may be a problem with the system. Have your vehicle checked by a dealer.

▣ Models with high voltage discharge tube bulbs

The headlights are suitable for left hand drive and right hand drive, without the need to make any adjustments or masking, as per UN-ECE R48 Dover Regulation.

▣ Models without high voltage discharge tube bulbs

You may need to alter the headlight beam distribution.

▣ **Adjusting Headlight Distribution** P. 480

* Not available on all models

High Beam Support System *

Uses the camera attached, monitors the space ahead of your vehicle, and automatically changes the low beam headlights to high beam headlights when necessary.

The system operates when:

- The headlight switch is in **AUTO**.
- The lever is in the low beam position.
- The system recognises that you are driving at night and the low beam headlights come on.
- The vehicle speed is above 40 km/h (25 mph).

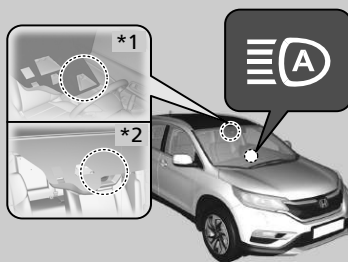

*1: Models with Forward Collision Warning
*2: Models without Forward Collision Warning

The system changes to high beam headlights when:

When the camera is not detecting any lights coming from preceding or oncoming vehicles: The headlights change to high beams.

When the camera detects lights coming from a preceding or oncoming vehicle: The headlights are returned to low beams.

The camera monitors the range within the 30~38-degree view angle. The distance that the camera can detect lights ahead differs depending on conditions, such as the brightness of the lights and the weather.

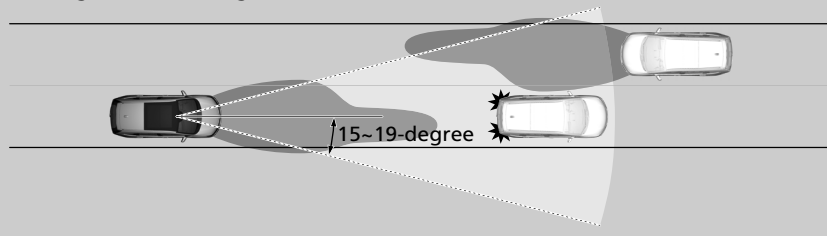

High Beam Support System *

The high beam support system determines when to change the headlight beams by responding to the brightness of the lights ahead of your vehicle. In the following cases, the system may not respond to the lights properly:

- The brightness of the lights from the preceding or oncoming vehicle is intense or poor.
- Visibility is poor due to the weather (rain, snow, fog, windscreen frost, etc.).
- Other light sources, such as streetlights and electric billboards are illuminating the road ahead.
- The brightness level of the road ahead constantly changes.
- The road is bumpy or with many curves.
- A vehicle cuts in front of you, or a vehicle in front of you is not in the preceding or oncoming direction.
- Your vehicle is tilted with a heavy load in the rear.

If you find the timing of beam changes inconvenient for driving, change the headlight beams manually.

If you do not want the system to be activated at any time when the headlight switch is in **AUTO**, consult a dealer.

■ To Operate the System

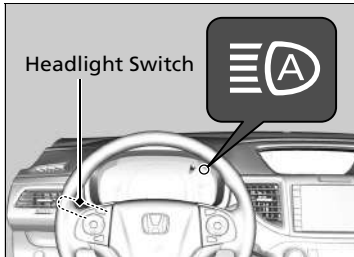

Turn the headlight switch in **AUTO** and pull the headlight lever to low beam.

▶ **Light Switches** P. 189

The high beam support system indicator comes on.

■ Temporary cancellation

The high beam support system operation is temporarily cancelled while:

- You are continuously driving at a speed below 24 km/h (15 mph).
- The vehicle speed is below 10 km/h (6 mph).
- The windscreen wipers run at high speed for more than a few seconds.

The system operation resumes once the condition that caused it to cancel improves.

■ To manually cancel the system temporarily

You can cancel the operation when you manually change the headlights to high beams. Push the lever forward until you hear a click, or lightly pull the lever towards you to flash high beams. The high beam support system indicator goes off.

If you want the high beam support system operation to resume at once, pull and hold the lever towards you for a few seconds.

▶ To Operate the System

For the high beam support system to work properly:

- Do not place an object that reflects light on the dashboard.
- Keep the windscreen around the camera clean. When cleaning the windscreen, be careful not to apply the windscreen cleanser to the camera lens.
- Do not attach an object, sticker or film in the area around the camera.
- Do not touch the camera lens.

If the camera receives a strong impact, or repairing of the area near the camera is required, consult a dealer.

▶ Models with Forward Collision Warning

If the  message appears:

- Use the climate control system to cool down the interior and, if necessary, also use defroster mode with the air flow directed towards the camera.
- Start driving the vehicle to lower the windscreen temperature, which cools down the area around the camera.

If the  message appears:

- Park your vehicle in a safe place, and clean the windscreen. If the message does not disappear after you have cleaned the windscreen and driven for a while, have your vehicle checked by a dealer.

Daytime Running Lights

The daytime running lights come on when the following conditions have been met:

- The ignition switch is in ON *1.
- The headlight switch is off.

*1: Models with the keyless access system have an **ENGINE START/STOP** button instead of an ignition switch.

Wipers and Washers

Windscreen Wipers/Washers

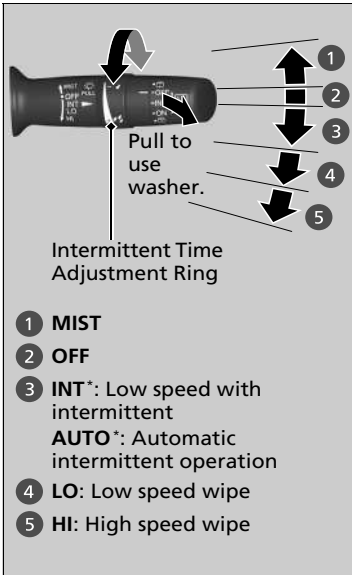

The windscreen wipers and washers can be used when the ignition switch is in ON (II)*1.

■ MIST

The wipers run at high speed until you release the lever.

■ Wiper switch (OFF, INT*, LO, HI)

Change the wiper switch setting according to the amount of rain.

■ AUTO*

🔌 Automatic Intermittent Wipers* P. 198

■ Adjusting wiper operation

Turn the adjustment ring to adjust wiper operation.



Lower speed, fewer sweeps

Higher speed, more sweeps

■ Washer

Sprays while you pull the lever towards you. When you release the lever for more than one second, the spray stops, the wipers sweep two or three more times to clear the windscreen, then stop.

*1: Models with the keyless access system have an **ENGINE START/STOP** button instead of an ignition switch.

* Not available on all models

Continued

Wipers and Washers

NOTICE

Do not use the wipers when the windscreen is dry. The windscreen will get scratched, or the rubber blades will get damaged.

NOTICE

In cold weather, the blades may freeze to the windscreen, becoming stuck. Operating the wipers in this condition may damage the wipers. Use the demister to warm the windscreen, then turn the wipers on.

If the vehicle speeds up while the wipers are operating intermittently, the length of the wipe interval shortens. When the vehicle starts moving, the wipers make a single sweep. When the vehicle speeds up, the wiper operation's shortest delay setting (🔌) and the **LO** setting become the same.

Turn the washers off if no washer fluid comes out. The pump may get damaged.

The wiper motor may stop motor operation temporarily to prevent an overload. Wiper operation will return to normal within a few minutes, once the circuit has returned to normal.

Automatic Intermittent Wipers*

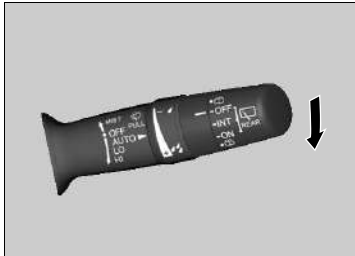



When you push the lever down to **AUTO**, the windshield wipers sweep once, and go into the automatic mode.

The wipers operate intermittently, at low speed, or at high speed and stops in accordance with the amount of rainfall the rainfall sensor detects.

■ AUTO sensitivity adjustment

When in **AUTO**, you can also adjust the rainfall sensor sensitivity using the intermittent time adjustment ring.

Sensor sensitivity

-  Low sensitivity:
Lower speed, fewer sweeps
-  High sensitivity:
Higher speed, more sweeps

Automatic Intermittent Wipers*

The rainfall sensor is in the location shown below.

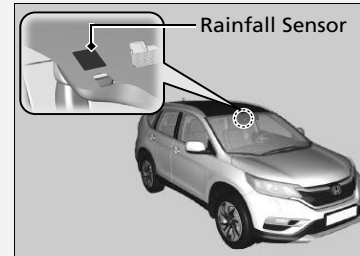

Do not put the wiper lever in **AUTO** when cleaning the windshield or driving through a car wash. If the wiper lever is in **AUTO**, and the ignition switch is in ON ^{*1}, the rainfall sensor may respond to your hand or car wash liquids, and the wipers may operate automatically.

*1: Models with the keyless access system have an **ENGINE START/STOP** button instead of an ignition switch.

■ Rear Wiper/Washer

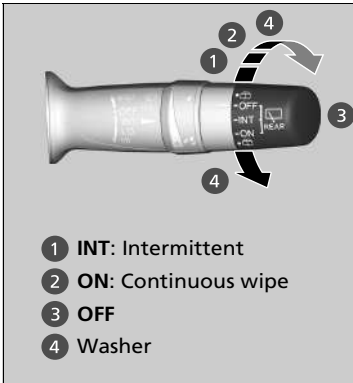

The rear wiper and washer can be used when the ignition switch is in ON *1.

■ Wiper switch (OFF, INT, ON)

Change the wiper switch setting according to the amount of rain.

■ Washer ()

Sprays while you rotate the switch to this position.

Hold it to activate the wiper and to spray the washer. Once released, it stops operating after a few more sweeps.



■ Operating in reverse

When you shift the transmission to  with the windscreen wipers activated, the rear wiper operates automatically as follows even if its switch is off.

Front Wiper Position	Rear Wiper Operation
INT (Intermittent)	Intermittent
LO (Low speed wipe)	Continuous
HI (High speed wipe)	

⊗ Rear Wiper/Washer

If the wiper stops operating due to any obstacle such as the build-up of snow, park the vehicle in a safe place.

Rotate the wiper switch to OFF, and turn the ignition switch to ACCESSORY  or LOCK *1, then remove the obstacle.

*1: Models with the keyless access system have an **ENGINE START/STOP** button instead of an ignition switch.

■ Headlight Washers*

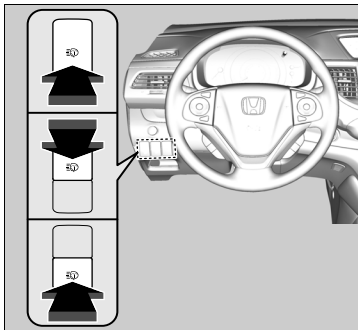

Turn the headlights on and press the headlight washers button to operate. The headlight washers also operate when you turn the windscreen washers for the first time after the ignition switch is turned to ON **II***1.

▣ Headlight Washers*

The headlight washers use the same fluid reservoir as the windscreen washers.

*1: Models with the keyless access system have an **ENGINE START/STOP** button instead of an ignition switch.

* Not available on all models

Brightness Control

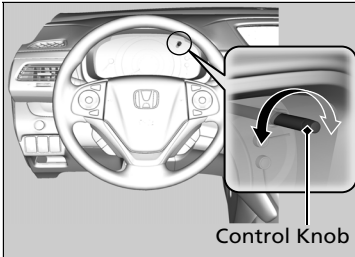

When the position lights are turned on and the ignition switch is in ON *1, you can use the brightness control knob to adjust instrument panel brightness.

Brighten: Turn the knob to the right.

Dim: Turn the knob to the left.

The multi-information display will return to its original state several seconds after you adjust the brightness.

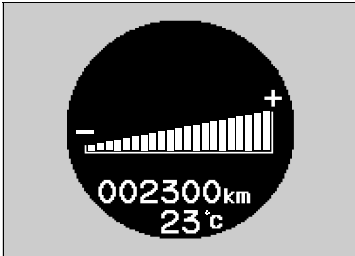

■ Brightness level indicator

The brightness level is shown on the multi-information display while you are adjusting it.



▣ Brightness Control

Instrument panel brightness differs between when the exterior lights are on and when they are off. The instrument panel dims to reduce glare when the lights are on.

Pressing the **SEL/RESET** button or either /  (information) button changes to a different display.

Turn the knob to the right until the brightness display is up to max. This cancels the reduced instrument panel brightness when the exterior lights are on.

*1: Models with the keyless access system have an **ENGINE START/STOP** button instead of an ignition switch.

Rear Demister/Heated Door Mirror Button

Press the rear demister and heated door mirror button to defog the rear window and mirrors when the ignition switch is in ON ^{*1}.



The rear demister and heated door mirrors automatically switch off after 10-30 minutes depending on the outside temperature. However, if the outside temperature is 0°C or below, they do not automatically switch off.

▶ Rear Demister/Heated Door Mirror Button

NOTICE

When cleaning the inside of the rear window, be careful not to damage the heating wires. It is critical to wipe the window from side to side along the demister heating wires.

This system consumes a lot of power, and may weaken the battery, making it difficult to start the engine. Turn it off when the window has been defogged. Also, do not use the system for a long period even if the engine is idling.

*1: Models with the keyless access system have an **ENGINE START/STOP** button instead of an ignition switch.

Driving Position Memory System*

You can store two driver's seat positions (except for power lumbar) with the driving position memory system.

When you unlock and open the driver's door with a remote transmitter or the keyless access system, the seat adjusts automatically to one of the two preset positions.

- Driver 1 transmitter is linked to memory button **1**.
- Driver 2 transmitter is linked to memory button **2**.



* Not available on all models

■ Storing a Position in Memory

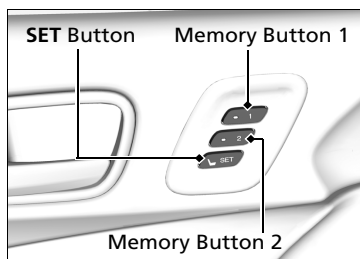

1. Set the power mode to ON. Adjust the driver's seat to the desired position.
2. Press the **SET** button.
 - ▶ The memory button indicator light will blink.
3. Press memory button **1** or **2** within five seconds of pressing the **SET** button.
 - ▶ Once the seat position has been memorized, the indicator light on the button you pressed stays on.

■ Recalling the Stored Position

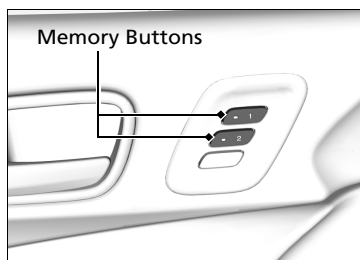

Automatic transmission models

1. Select the transmission to **P**.
2. Press a memory button **1** or **2**.
 - ▶ The indicator light blinks.

Manual transmission models

1. Apply the parking brake.
2. Press a memory button **1** or **2**.
 - ▶ The indicator light blinks.

⊗ Storing a Position in Memory

After you press the **SET** button, the storing operation will be cancelled when:

- You do not press the memory button within five seconds.
- You readjust the seat position.
- You set the power mode to any position except ON **II**.

⊗ Recalling the Stored Position

The seat will automatically move to the memorized position. When it has finished moving, the indicator light stays on.

The seat will stop moving if you:

- Press the **SET** button, or a memory button **1** or **2**.
- Adjust the seat position.
- Shift into any position except **P** (automatic transmission).
- Release the parking brake (manual transmission).

Manual transmission models

By pressing and holding a memory button **1** or **2**, you can recall the seat memory without first setting the parking brake.

Adjusting the Steering Wheel

The steering wheel height and distance from your body can be adjusted so that you can comfortably grip the steering wheel in an appropriate driving posture.

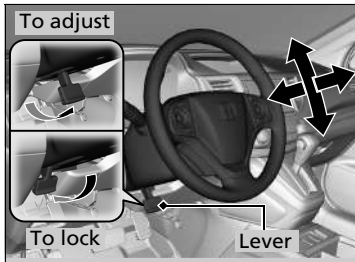

1. Pull the steering wheel adjustment lever up.
 - The steering wheel adjustment lever is under the steering column.
2. Move the steering wheel up or down, and in or out.
 - Make sure you can see the instrument panel gauges and indicators.
3. Push the steering wheel adjustment lever down to lock the steering wheel in position.
 - After adjusting the position, make sure you have securely locked the steering wheel in place by trying to move it up, down, in, and out.

Adjusting the Steering Wheel

⚠ WARNING

Adjusting the steering wheel position while driving may cause you to lose control of the vehicle and be seriously injured in a crash.

Adjust the steering wheel only when the vehicle is stopped.

Make any steering wheel adjustments before you start driving.

Interior Rearview Mirror

Adjust the angle of the rearview mirror when you are sitting in the correct driving position.

Adjusting the Mirrors

Keep the inside and outside mirrors clean and adjusted for best visibility.

Adjust the mirrors before you start driving.

Adjusting the Seat Positions P. 210

Rearview Mirror with Day and Night Positions*

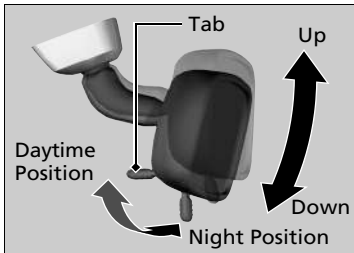

Dimming the rearview mirror

Flip the tab to switch the position.

The night position will help to reduce the glare from headlights behind you when driving after dark.

Automatic Dimming Rearview Mirror*

Models with auto button

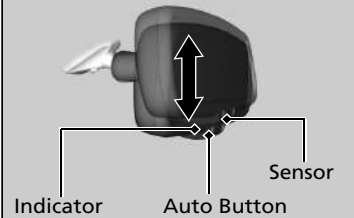

Models without auto button

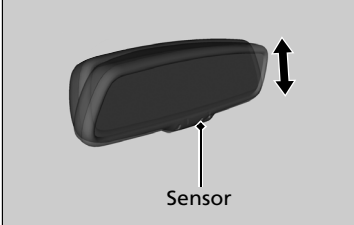

When driving after dark, the automatic dimming rearview mirror reduces the glare from headlights behind you.

Models with auto button

Press the auto button to turn this function on and off. When activated, the auto indicator comes on.

Automatic Dimming Rearview Mirror*

The auto dimming function cancels when the shift position is in **[R]**.

* Not available on all models

Power Door Mirrors

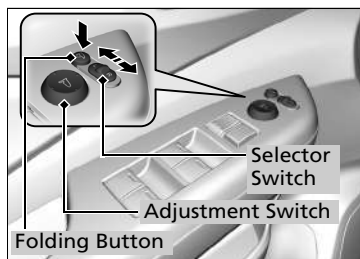

You can adjust the door mirrors when the ignition switch is in ON **II***1.

■ Mirror position adjustment

L/R selector switch: Select the left or right mirror. After adjusting the mirror, return the switch to the centre position.

Mirror position adjustment switch: Press the switch left, right, up, or down to move the mirror.

■ Folding door mirrors*

Press the folding button to fold in and out the door mirrors.

Reverse Tilt Door Mirror*

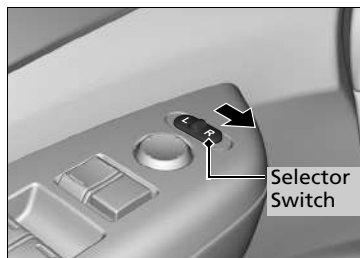

If activated, the passenger side door mirror automatically tilts downward when you change the gear position to **R**; this improves close-in visibility on the passenger side of the vehicle when backing up. The mirror automatically returns to its original position when you change the gear position out of **R**.

To activate this feature, turn the ignition switch to ON **II***1 and slide the selector switch to the passenger's side.

*1: Models with the keyless access system have an **ENGINE START/STOP** button instead of an ignition switch.

* Not available on all models

Automatic Folding Door Mirror Function *

■ Folding in the door mirrors

Press the lock button on the remote transmitter or keyless remote twice within 10 seconds, and hold it.

- ▶ You can release the button once the mirrors start folding in automatically.

Models with keyless access system

Press the door lock button on either front door or the tailgate twice within 10 seconds, and hold it.

- ▶ You can release the button once the mirrors start folding in automatically.

■ Folding out the door mirrors

Unlock all doors and the tailgate using the remote transmitter or keyless remote. Open the driver's door.

- ▶ The mirrors start folding out automatically.

Models with keyless access system

Grab the door handle on either front door and unlock all doors. Open the driver's door.

- ▶ The mirrors start folding out automatically.

*1: Models with the keyless access system have an **ENGINE START/STOP** button instead of an ignition switch.

* Not available on all models

☒ Folding out the door mirrors

The door mirrors do not fold out automatically if they have been folded in using the folding button.

Adjusting the Seats

Adjusting the Seat Positions

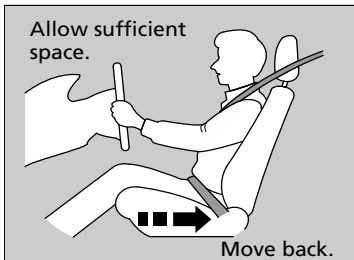

Adjust the driver's seat as far back as possible while allowing you to maintain full control of the vehicle. You should be able to sit upright, well back in the seat and be able to adequately press the pedals without leaning forward, and grip the steering wheel comfortably. The passenger's seat should be adjusted in a similar manner, so that it is as far back from the front airbag in the dashboard as possible.

Adjusting the Seats

⚠ WARNING

Sitting too close to a front airbag can result in serious injury or death if the front airbags inflate.

Always sit as far back from the front airbags as possible while maintaining control of the vehicle.

In addition to the seat adjustment, you can adjust the steering wheel up and down, in and out. Allow at least 25 cm (10 inches) between the centre of the steering wheel and the chest.

Always make seat adjustments before driving.

Once a seat is adjusted correctly, rock it back and forth to make sure it is locked in position.

■ Adjusting the front power seat*

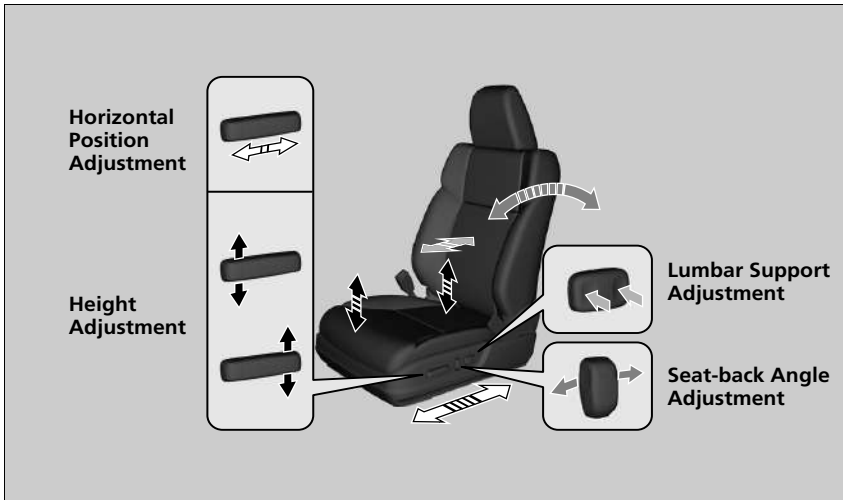

■ Adjusting the front manual seat(s)

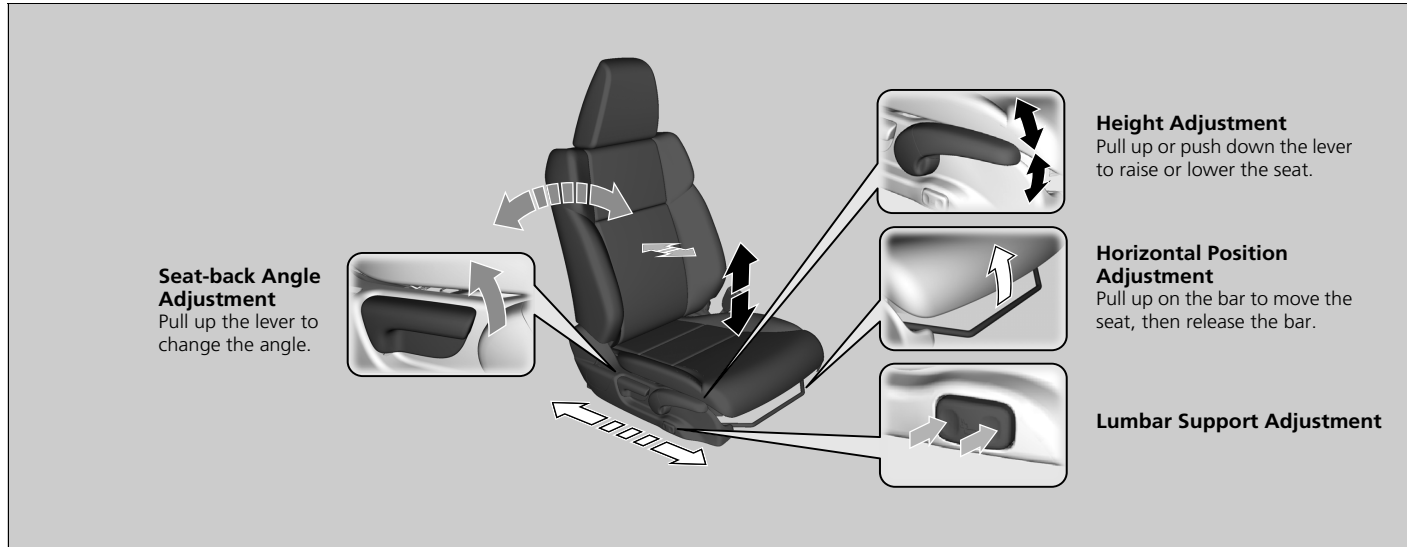

■ Adjusting the Seat-Backs

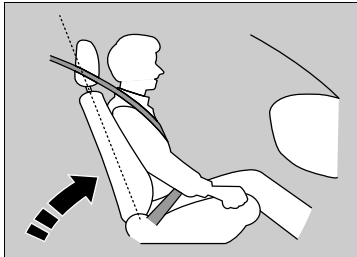

Adjust the driver's seat-back to a comfortable, upright position, leaving ample space between your chest and the airbag cover in the centre of the steering wheel.

The front seat passenger should also adjust their seat-back to a comfortable, upright position.

Reclining a seat-back so that the shoulder part of the belt no longer rests against the occupant's chest reduces the protective capability of the belt. It also increases the chance of sliding under the belt in a crash and being seriously injured. The farther a seat-back is reclined, the greater the risk of injury.

▣ Adjusting the Seat-Backs

⚠ WARNING

Reclining the seat-back too far can result in serious injury or death in a crash.

Adjust the seat-back to an upright position, and sit well back in the seat.

Do not put a cushion, or other object, between the seat-back and your back.

Doing so may interfere with proper seat belt or airbag operation.

If you cannot get far enough away from the steering wheel and still reach the controls, we recommend that you investigate whether some type of adaptive equipment may help.

■ Adjusting the Head Restraints

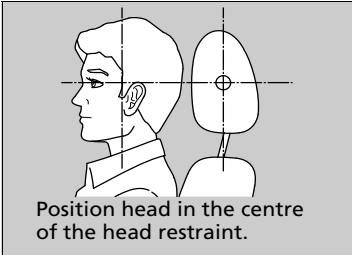

Your vehicle is equipped with head restraints in all seating positions.

Head restraints are most effective for protection against whiplash and other rear-impact crash injuries when the centre of the back of the occupant's head rests against the centre of the restraint. The tops of the occupant's ears should be level with the centre height of the restraint.

■ Adjusting the front head restraint positions

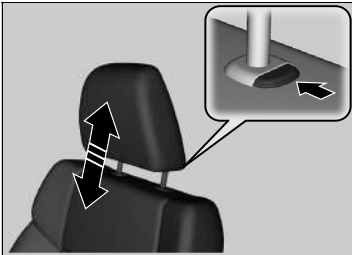

To raise the head restraint:

Pull it upward.

To lower the head restraint:

Push it down while pressing the release button.

▶▶ Adjusting the Head Restraints

⚠ WARNING

Improperly positioning head restraints reduces their effectiveness and increases the likelihood of serious injury in a crash.

Make sure head restraints are in place and positioned properly before driving.

In order for the head restraint system to work properly:

- Do not hang any items on the head restraints, or from the restraint legs.
- Do not place any objects between an occupant and the seat-back.
- Install each restraint in its proper location.

■ Changing the Centre Rear Seat Head Restraint Position

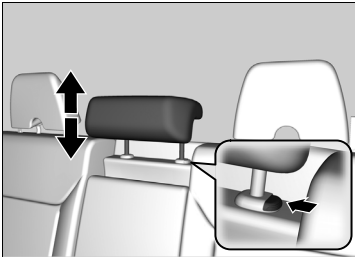

A passenger sitting in the centre back seating position should adjust the height of their head restraint to an appropriate position before the vehicle begins moving.

To raise the head restraint:

Pull it upward.

To lower the head restraint:

Push it down while pressing the release button.

☒ Changing the Centre Rear Seat Head Restraint Position

When you use the head restraint in the centre rear seating position, pull up the head restraint to its highest position. Do not use it in any lower position.

☒ Removing and Reinstalling the Head Restraints

Front and rear centre head restraints

Head restraints can be removed for cleaning or repair.

To remove a head restraint:

Pull the restraint up as far as it will go. Then push the release button, and pull the restraint up and out.

To reinstall a head restraint:

Insert the legs back in place, then adjust the head restraint to an appropriate height while pressing the release button. Pull up on the restraint to make sure it is locked in position.

⚠ WARNING

Failure to reinstall, or correctly reinstall, the head restraints can result in severe injury during a crash.

Always replace the head restraints before driving.

■ Folding Down the Rear Outer Head Restraint

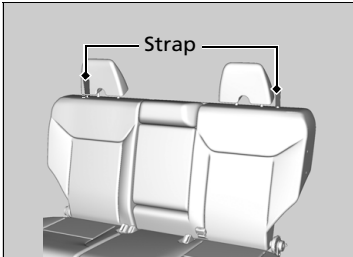

A passenger in an outer back seating position should put the head restraint in the upright position before the vehicle begins moving.

To fold down the head restraint:

Pull the strap.

To put the head restraint back in the upright position:

Pull up the head restraint and push rearward until it latches.

■ Maintain a Proper Sitting Position

After all occupants have adjusted their seats and head restraints, and put on their seat belts, it is very important that they continue to sit upright, well back in their seats, with their feet on the floor until the vehicle is safely parked and the engine is off.

Sitting improperly can increase the chance of injury during a crash. For example, if an occupant slouches, lies down, turns sideways, sits forward, leans forward or sideways, or puts one or both feet up, the chance of injury during a crash is greatly increased.

In addition, an occupant who is out of position in the front seat can be seriously or fatally injured in a crash by striking interior parts of the vehicle or being struck by an inflating front airbag.

▣ Maintain a Proper Sitting Position

WARNING

Sitting improperly or out of position can result in serious injury or death in a crash.

Always sit upright, well back in the seat, with your feet on the floor.

Rear Seats

Folding Down the Rear Seats

The rear seats can fold down separately to allow for additional storage space.

■ To fold down the seat

1. Store the centre seat belt first. Insert the latch plate into the slot on the side of the anchor buckle.
2. Retract the seat belt into the holder on the ceiling.
 - ▣ **Seat Belt with Detachable Anchor** P. 45
3. Lower the centre head restraint to its lowest position. Put the armrest back into the seat-back.

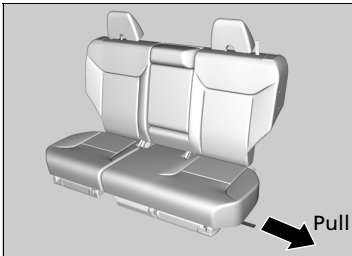

From the rear door side

4. Pull the release strap.
 - ▶ The seat cushion flips forward, the head restraints tilt downward, and the seat-back then folds flat.

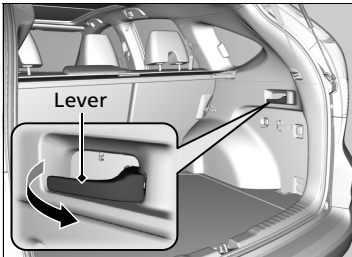

From the luggage area side

4. Pull the release lever.
 - ▶ The seat cushion flips forward, the head restraints tilt downward, and the seat-back then folds flat.

▣ Rear Seats

⚠ WARNING

Make sure the seat-backs are latched securely before driving.

▣ Folding Down the Rear Seats

Make sure all items in the luggage area or items extending to the rear seats are properly secured. Loose items can fly forward if you have to brake hard.

Remove any items from the rear seat cushion and floor before you fold down the rear seat.

Make sure the seat-back completely lowers (a click sounds). Otherwise it will not re-latch when returned to the upright position.

The front seat(s) must be far enough forward so they do not interfere with the rear seats as they fold down.

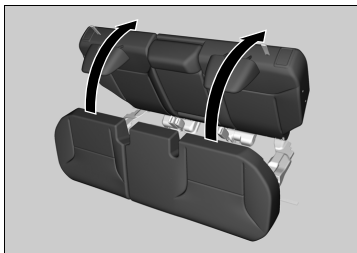

■ **To return the seat to the original position**

1. Pull the seat-back up and push back into place until a click is heard.
2. Push the head restraint up to its original position.
3. Pull the seat cushion up and push it down into its original position.



■ **Rear Seat-back Adjusting**



Pull the lever on the right to change the angle of the right half of the seat-back, and left for the left half.

☒ **To return the seat to the original position**

Make sure the seat-back, head restraints and seat cushion are securely latched back into place before driving.

Armrest

■ Using the Front Seat Armrest

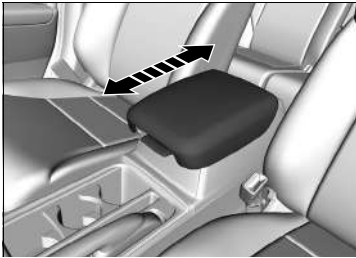

The console lid can be used as an armrest.

To adjust:

Slide the armrest to a desired position.

■ Using the Rear Seat Armrest

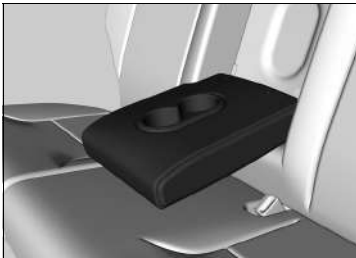

Pull down the armrest in the centre seat-back.

Interior Lights

Interior Light Switches

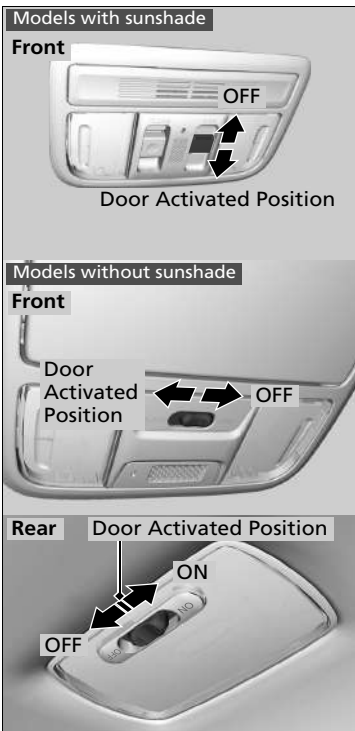

■ ON

The interior lights come on regardless of whether the doors are open or closed.

■ Door activated

The interior lights come on in the following situations:

- When any doors are opened.
- You unlock the driver's door.

Models without keyless access system

- You remove the key from the ignition switch.

Models with keyless access system

- When the power mode is set to VEHICLE OFF (LOCK).

■ OFF

The interior lights remain off regardless of whether the doors are open or closed.

» Interior Light Switches

In the door activated position, the interior lights fade out and goes off about 30 seconds after the doors are closed.

The lights go off after 30 seconds in the following situations:

- When you unlock the driver's door but do not open it.
- Models without keyless access system**
- When you remove the key from the ignition switch but do not open a door.

Models with keyless access system

- When you set the power mode to VEHICLE OFF (LOCK) but do not open a door.

The interior lights go off immediately in the following situations:

- When you lock the driver's door.

Models without keyless access system

- When you close the driver's door with the key in the ignition switch.
- When you turn the ignition switch to ON *1.

Models without keyless access system

If you leave any doors open without the key in the ignition switch, the interior lights go off after about 15 minutes.

Models with keyless access system

If you leave any doors open with power mode in VEHICLE OFF (LOCK), the interior lights go off after about 15 minutes.

*1: Models with the keyless access system have an **ENGINE START/STOP** button instead of an ignition switch.

■ Map Lights

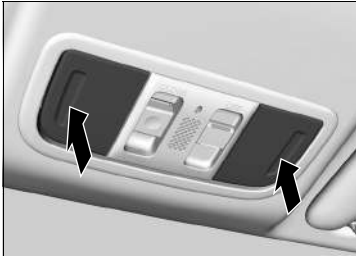

The map lights can be turned on and off by pressing the lenses.

▣ Map Lights

When the ceiling light switch is in the door activated position and any door is open, the map light will not go off when you press the lens.

Interior Convenience Items

Glove Box

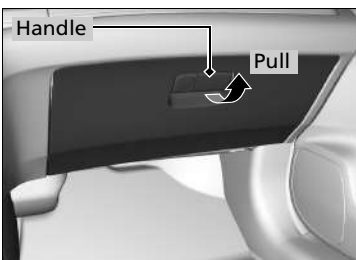

Pull the handle to open the glove box.

Glove Box

⚠ WARNING

An open glove box can cause serious injury to your passenger in a crash, even if the passenger is wearing the seat belt.

Always keep the glove box closed while driving.

Console Compartment

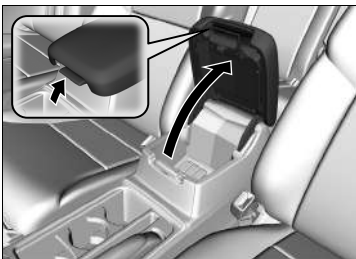

Pull the handle to open the console compartment.

Beverage Holders

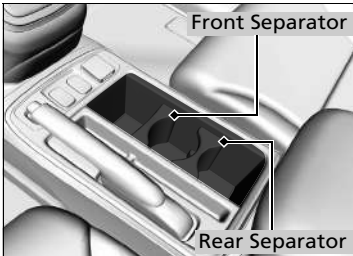

■ Front seat beverage holders

Are located in the console between the front seats.

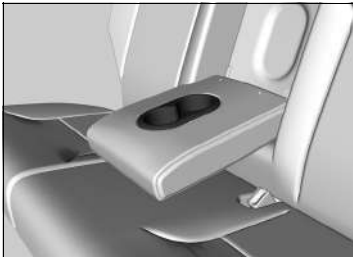

■ Rear seat beverage holders

Fold the armrest down to use the rear seat beverage holders.

☒ Beverage Holders

NOTICE

Spilled liquids damage the upholstery, carpeting, and electrical components in the interior.

Be careful when you are using the beverage holders. Hot liquid can scald you.

The front and rear separators are not interchangeable, and are labelled with their appropriate locations. Always ensure they are positioned as shown.

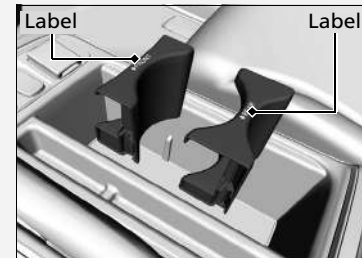

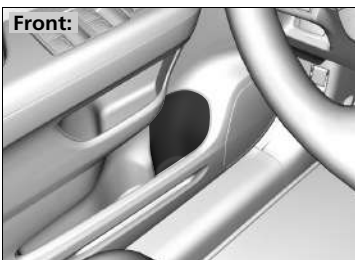



■ **Door side beverage holders**

Are located on the both of front and rear door side pockets.

■ Accessory Power Sockets

The accessory power sockets can be used when the ignition switch is in ACCESSORY  or ON *1.

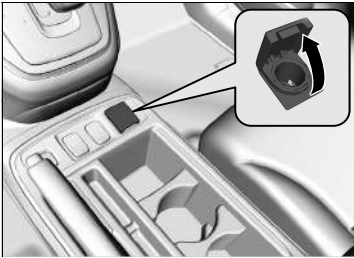

■ Accessory power socket on the console panel

Open the cover to use it.

▣ Accessory Power Sockets

NOTICE

Do not insert an automotive type cigarette lighter element.

This can overheat the power socket.

The accessory power socket is designed to supply power for 12 volt DC accessories that are rated 180 watts or less (15 amps).

To prevent battery drain, only use the power socket with the engine running.

*1: Models with the keyless access system have an **ENGINE START/STOP** button instead of an ignition switch.

Continued

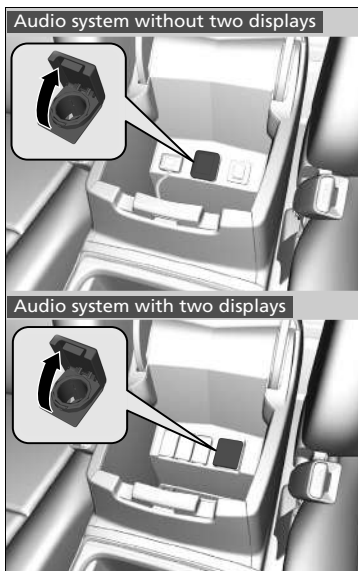

■ **Accessory power socket in the console compartment**

Open the console lid and the cover to use it.

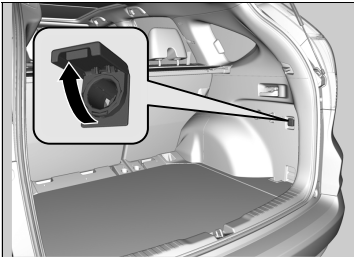

■ **Accessory power socket in the luggage area**

Open the cover to use it.

Coat Hooks

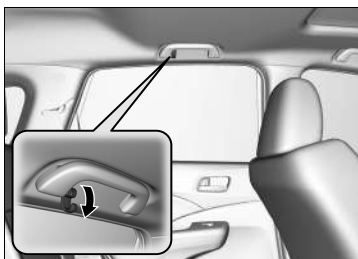

There are coat hooks on the rear left and right grab handles. Pull them down to use them.



There are coat hooks on the left and right door pillars.

Coat Hooks

The coat hooks are not designed for large or heavy items.

■ Tie-down Anchors

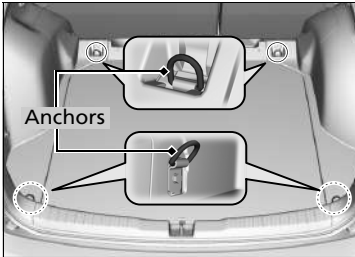

The tie-down anchors on the luggage area floor can be used to install a net for securing items.

■ Luggage Hooks

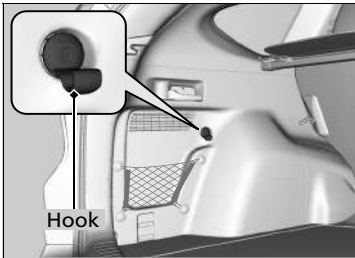

The luggage hooks on both sides of the luggage area can be used to hang a light items.

▣ Tie-down Anchors

Do not let anyone access items in the luggage area while driving. Loose items can cause injury if you have to brake hard.

▣ Luggage Hooks

NOTICE

Do not hang a large object or an object that weighs more than 3 kg (6 lbs) on the side luggage hooks. Hanging heavy or large objects may damage the hooks.

■ Sunglasses Holder*



To open the sunglasses holder, push and release the indent. To close, push it again until it latches.

You can store eyeglasses and other small items in this holder.



■ Conversation mirror*

The sunglasses holder comes with a mirror. Open the sunglasses holder fully, then push it back to the first detent.

You can use the mirror to view the rear seats.

☒ Sunglasses Holder*

Keep the holder closed while driving except when accessing stored items.

Seat Heaters*



The ignition switch must be in ON **II***¹ to use the seat heaters. The **HI** setting heats the seats faster than the **LO** setting.

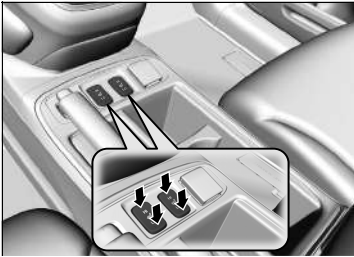

The indicator for your setting comes on while the seat heater is in use. Press the button on the opposite side to turn the heater off. The indicator goes off.

While in **HI**, the heater cycles on and off. When a comfortable temperature is reached, select **LO** to keep the seat warm.

*1: Models with the keyless access system have an **ENGINE START/STOP** button instead of an ignition switch.

* Not available on all models

Continued

Seat Heaters*

WARNING

Heat induced burns are possible when using seat heaters.

Persons with a diminished ability to sense temperature (e.g., persons with diabetes, lower-limb nerve damage, or paralysis) or with sensitive skin should not use seat heaters.

Do not use the seat heaters even in **LO** when the engine is off. Under such conditions, the battery may be weakened, making the engine difficult to start.

In the **LO** setting, the heater runs continuously and does not automatically turn off.

■ Tonneau Cover*

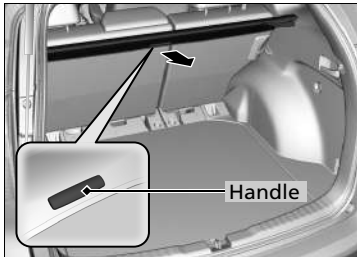

The tonneau cover can be used to conceal items in the luggage area and protect them from direct sunlight.

■ To extend:

Pull the handle on the centre edge, then clip the mounting rods in the hooks on both sides of the tailgate opening.

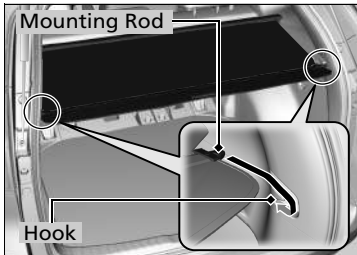

■ To retract:

Slip the rods out of the hooks, then slowly roll it back until it is completely retracted.

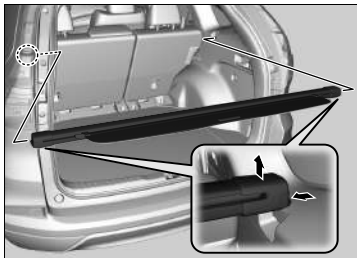

■ To remove:

Push either end of the housing inward, then lift it out of its position.

▣ Tonneau Cover*

Do not let anyone access items in the luggage area while driving. Loose items can cause injury if you have to brake hard.

Do not stack objects higher than the top of the seat in the luggage area. They could block your view and be thrown about the vehicle during a sudden stop.

To prevent tonneau cover damage:

- Do not place items on the tonneau cover.
- Do not put weight on the tonneau cover.

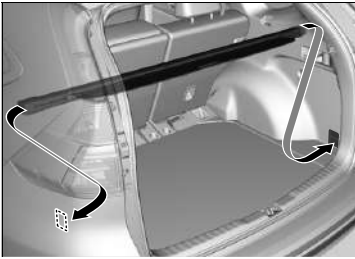

■ **To store:**

The housing unit can be stored on the luggage area floor to make more space available.

Push one end of the unit into the hole on one side panel, then insert the other end into the hole on the other side.

After storing the unit, rock it up and down to make sure it is securely placed.

Using Automatic Climate Control

The automatic climate control system maintains the interior temperature you select.

Models with air conditioning system

The system also selects the proper mix of heated or cooled air that raises or lowers the interior temperature to your preference as quickly as possible.

Models without air conditioning system

The system also selects the proper mix of heated or outside air that raises or lowers the interior temperature to your preference.

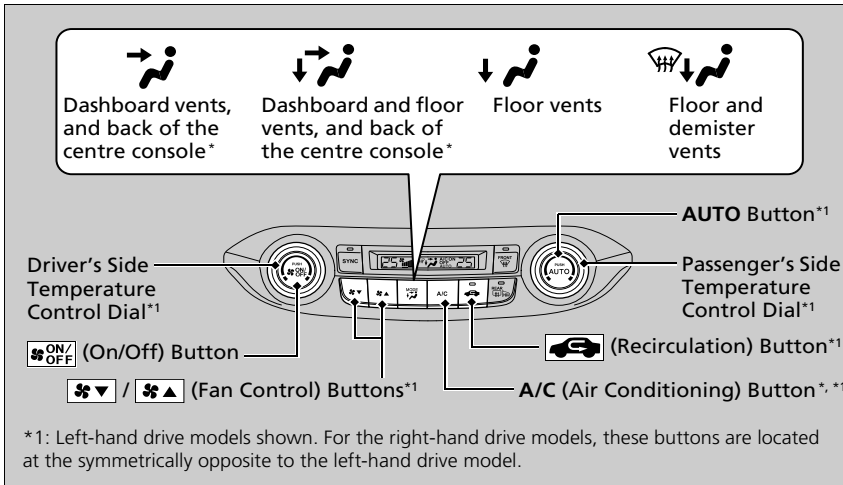

Use the system when the engine is running.

1. Press the **AUTO** button.
2. Adjust the interior temperature using the driver's side or passenger's side temperature control dial.
3. Press the (On/Off) button to cancel.

* Not available on all models

Using Automatic Climate Control

If any button is pressed while in **AUTO**, the function of that button takes priority.

The **AUTO** indicator goes off, but functions of other buttons pressed are still in auto mode.

To prevent cold air from blowing in from outside, the fan may operate at low speed for a while after the **AUTO** button has been pressed.

Models with Auto Idle Stop

During the Auto Idle Stop, the air conditioning system will be turned off.

If the interior is very warm, you can cool it down more rapidly by partially opening the windows, turning the system on **AUTO**, and setting the temperature to low. Change the fresh air mode to recirculation mode until the temperature cools down.

When you set the temperature to the lower or upper limit, **Lo** or **Hi** is displayed.

■ Switching between the recirculation and fresh air modes

Press the  button and switch the mode depending on environmental conditions.

Recirculation mode (indicator on): Recirculates air from the vehicle's interior through the system.

Fresh air mode (indicator off): Maintains outside ventilation. Keep the system in fresh air mode in normal situations.

■ Defrosting the Windscreen and Windows

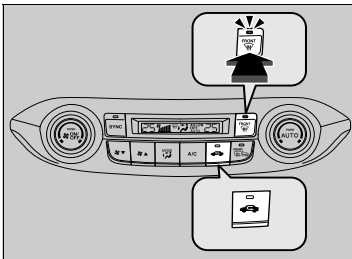



Models with air conditioning system

Pressing the  button turns the air conditioning system on and automatically switches the system to fresh air mode.

Pressing the  button again to turn the previous settings.

Models without air conditioning system

Pressing the  button automatically switches the system to fresh air mode.

Pressing the  button again to turn the previous settings.

►► Using Automatic Climate Control

Pressing the  button switches the climate control system between on and off. When turned on, the system returns to your last selection.

While in ECON mode, the system may allow greater temperature fluctuations.

►► Defrosting the Windscreen and Windows

For your safety, make sure you have a clear view through all the windows before driving.

Do not set the temperature near the lower limit. When cold air hits the windscreen, the outside of the windscreen may fog up.

If the side windows fog up, adjust the vents so that the air hits the side windows.

■ To rapidly defrost the windows

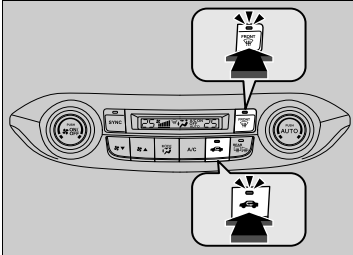

1. Press the  button.
2. Press the  button.

☒ To rapidly defrost the windows

After defrosting the windows, switch over to fresh air mode. If you keep the system in recirculation mode, the windows may fog up from humidity. This impedes visibility.

Synchronized Mode

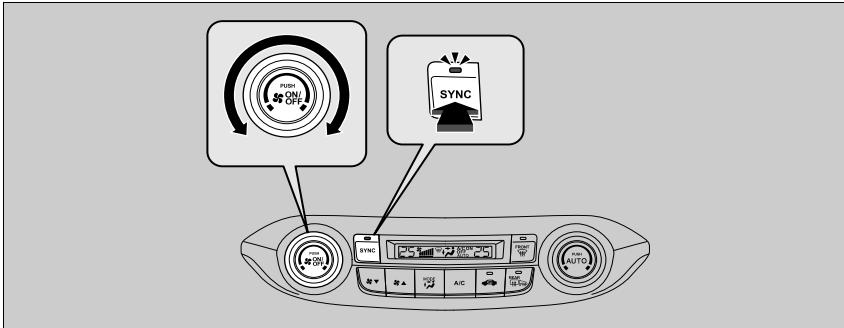

You can set the temperature synchronously for the driver side and the passenger side in synchronized mode.

1. Press the **SYNC** button.
 - The system switches to synchronized mode.
2. Adjust the temperature using driver's side temperature control dial.

Press the **SYNC** button or change the passenger side temperature setting to return to dual mode.

► Synchronized Mode

When you press the  button, the system changes to synchronized mode.

When the system is in dual mode, the driver side temperature and the passenger side temperature can be set separately.

Models with navigation system

In AUTO mode, the system adjusts each temperature based on the information of the sunlight sensor and the sun position updated by the navigation system's GPS.

Automatic Climate Control Sensors

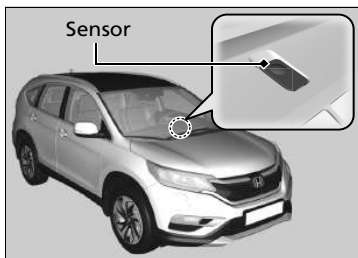

The automatic climate control system is equipped with sensors. Do not cover or spill any liquid on them.

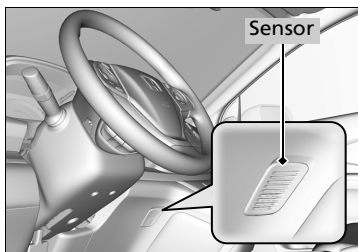

Features

This chapter describes how to operate technology features.

Audio System*	
About Your Audio System	240
USB Adapter Cable*	241
Auxiliary Input Jack*	243
HDMI™ Port*	243
Audio System Theft Protection	244
Audio Remote Controls	245
Audio system with one display	
Audio System Basic Operation	247
Audio system with two displays	
Audio System Basic Operation	270

Audio Error Messages	
CD Player*	315
iPod/USB Flash Drive	316
Android/Apps	318
General Information on the Audio System	
Recommended CDs*	319
Compatible iPod, iPhone, and USB Flash Drive	320
About Open Source Licences	322

Audio system with one display	
Hands-Free Telephone System*	
Using HFT	340
HFT Menus	342
Audio system with two displays	
Hands-Free Telephone System*	
Using HFT	364
HFT Menus	367

* Not available on all models

About Your Audio System

Models with navigation system

See the Navigation System Manual for operation on the navigation system.

The audio system features AM/FM radio. It can also play audio CDs*, WMA/MP3/AAC files, USB flash drives, and iPod, iPhone, and *Bluetooth*® devices.

You can operate the audio system from the buttons and switches on the panel, or the remote controls on the steering wheel or on the touch screen interface*.

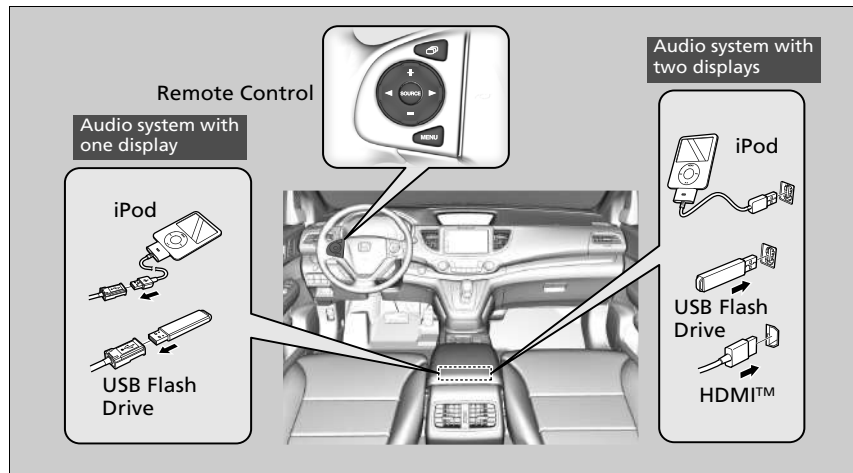

About Your Audio System

Video CDs, DVDs, and 8-cm (3-inch) mini CDs are not supported.

iPod, iPhone and iTunes are trademarks of Apple Inc.

After you turn the ignition switch to LOCK [0]*¹, you can use the audio system for up to 30 minutes per driving cycle. However, whether you can continue using the audio system depends on the battery condition. Repeatedly using this feature may drain the battery.

* 1: Models with the keyless access system have an **ENGINE START/STOP** button instead of an ignition switch.

USB Adapter Cable*

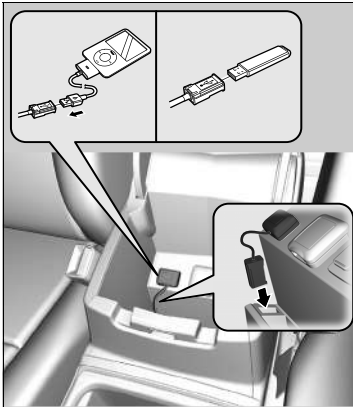

1. Unclip the USB connector and loosen the adapter cable.
2. Install the iPod dock connector or the USB flash drive to the USB connector.

▣ USB Adapter Cable*

- Do not leave the iPod or USB flash drive in the vehicle. Direct sunlight and high temperatures may damage it.
- Do not use an extension cable with the USB adapter cable.
- Do not connect the iPod or USB flash drive using a hub.
- Do not use a device such as a card reader or hard disk drive, as the device or your files may be damaged.
- We recommend keeping your data backed up before using the device in your vehicle.
- Displayed messages may vary depending on the device model and software version.

If the audio system does not recognize the iPod, try reconnecting it a few times or reboot the device. To reboot, follow the manufacturer's instructions provided with the iPod or visit www.apple.com/ipod.

* Not available on all models

USB Ports*

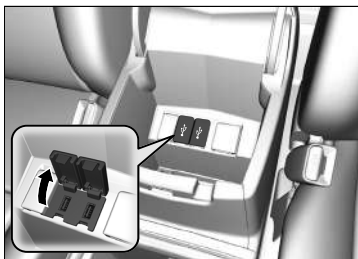

1. Open the cover.
2. Install the iPod USB connector or the USB flash drive to the USB port.

⊞ USB Ports*

- Do not leave the iPod or USB flash drive in the vehicle. Direct sunlight and high temperatures may damage it.
- We recommend using an extension cable with the USB port.
- Do not connect the iPod or USB flash drive using a hub.
- Do not use a device such as a card reader or hard disk drive, as the device or your files may be damaged.
- We recommend keeping your data backed up before using the device in your vehicle.
- Displayed messages may vary depending on the device model and software version.

If the audio system does not recognize the iPod, try reconnecting it a few times or reboot the device. To reboot, follow the manufacturer's instructions provided with the iPod or visit www.apple.com/ipod.

Auxiliary Input Jack*

Use the jack to connect standard audio devices.

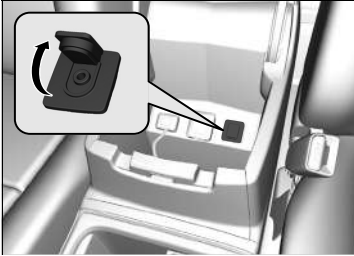

1. Open the cover.
2. Connect a standard audio device to the input jack using a 3.5mm (1/8 inch) stereo miniplug.
 - ▶ The audio system automatically switches to the AUX mode.

HDMI™ Port*

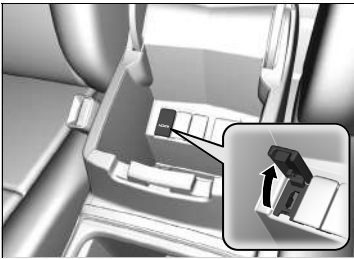

1. Open the cover.
2. Install the HDMI™ cable to the HDMI™ port.

▶▶ Auxiliary Input Jack*

To switch the mode, press any of the audio mode buttons. You can return to the AUX mode by pressing the **CD/AUX** button.

You cannot use the auxiliary input jack if you replace the audio system.

▶▶ HDMI™ Port*

- Do not leave the HDMI™ connected device in the vehicle. Direct sunlight and high temperatures may damage it.
- We recommend keeping your data backed up before using the device in your vehicle.
- Displayed messages may vary depending on the device model and software version.

The terms HDMI and HDMI High-Definition Multimedia Interface, and the HDMI Logo are trademarks or registered trademarks of HDMI Licensing LLC in the United States and other countries.

* Not available on all models

Audio System Theft Protection

The audio system is disabled when it is disconnected from the power source, such as when the battery is disconnected or goes dead. In certain conditions, the system may display a passcode input mode. If it does, reactivate the audio system.

■ Reactivating the audio system

1. Turn the ignition switch to ON *1.
2. Turn on the audio system.
3. Press and hold the audio system power button for more than two seconds.
 - ▶ The audio system is reactivated when the audio control unit establishes a connection with the vehicle control unit. If the control unit fails to recognise the audio unit, you must go to a dealer and have the audio unit checked.

*1: Models with the keyless access system have an **ENGINE START/STOP** button instead of an ignition switch.

Audio Remote Controls

Allow you to operate the audio system while driving.

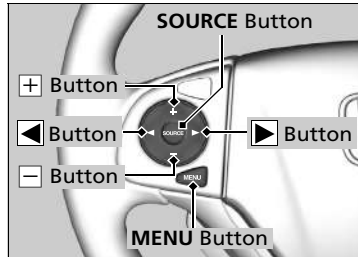

SOURCE Button

Cycles through the audio modes as follows:

Audio system with one display

FM1→FM2→DAB1*→DAB2*→LW→MW
→CD→AUX

Audio system with two displays

FM→LW→MW→DAB→CD*→USB→iPod
→Apps→Bluetooth® Audio→AUX HDMI™

+ - (Volume) Buttons

Press +: To increase the volume.

Press -: To decrease the volume.

◀ ▶ Buttons

- When listening to the radio
 - Press** ▶: To select the next preset radio station.
 - Press** ◀: To select the previous preset radio station.
 - Press and hold** ▶: To select the next strong station.
To select the next service (DAB*).
 - Press and hold** ◀: To select the previous strong station.
To select the previous service (DAB*).
- When listening to a CD*, iPod, USB flash drive, or Bluetooth® Audio
 - Press** ▶: To skip to the next song.
 - Press** ◀: To go back to the beginning of the current or previous song.
- When listening to a CD* or USB flash drive
 - Press and hold** ▶: To skip to the next folder.
 - Press and hold** ◀: To go back to the previous folder.

* Not available on all models

▶▶ Audio Remote Controls

Some mode appears only when an appropriate device or medium is used.

Depending on the Bluetooth® device you connect, some functions may not be operated.

Continued

Audio system with two displays

Steering Wheel **MENU** Button

- When listening to the radio
Press and hold the MENU button: To select the radio station by **Scan, Save Preset, or Seek.**
- When listening to a CD* or USB flash drive
Press and hold the MENU button: To select the song by **Scan, Repeat, Random, or Play/Pause***.
- When listening to an iPod
Press and hold the MENU button: To select the song by **Repeat or Shuffle.**
- When listening to a *Bluetooth*® Audio
Press and hold the MENU button: To select **Pause** or **Play** for the song.

▶▶ Audio Remote Controls

Audio system with two displays

The **MENU** button is available only when the audio mode is FM, AM, CD*, USB, iPod, or *Bluetooth*® Audio.

Audio System Basic Operation

Audio system with one display

To use the audio system, the ignition switch must be in ACCESSORY  or ON *1.

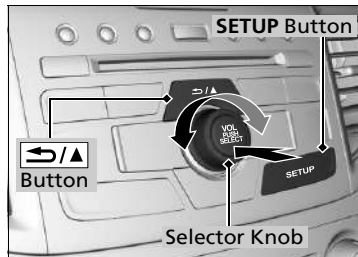

Use the selector knob or **SETUP** button to access some audio functions.

Press  to switch between the normal and extended display for some functions.

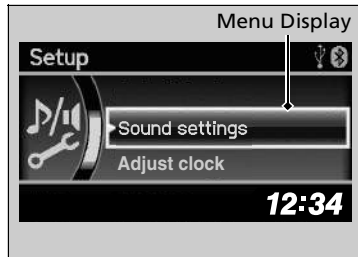

Selector knob: Rotate left or right to scroll through the available choices. Press  to set your selection.

SETUP button: Press to select any mode such as the **Sound settings**, Radio Data System (RDS) settings, **DAB settings**, **Play mode**, **Resume/Pause**, **Radio text** or **Adjust clock**.





Button: Press to go back to the previous display.

Audio System Basic Operation

These indications are used to show how to operate the selector knob.

Rotate  to select.

Press  to enter.

Press the **SOURCE**, , ,  or  button on the steering wheel to change any audio setting.

➤ **Audio Remote Controls** P. 245

Setup menu items

➤ **Sound settings** P. 248

➤ **RDS settings** P. 252

➤ **DAB settings** P. 258



➤ **Play mode** P. 261

➤ **Resume/Pause** P. 269

*1: Models with the keyless access system have an **ENGINE START/STOP** button instead of an ignition switch.

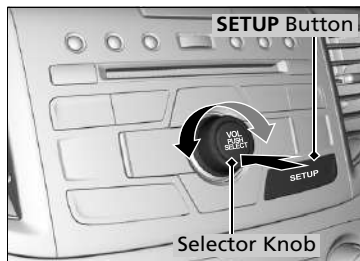
Adjusting the Sound



Press the **SETUP** button, and rotate  to select **Sound settings**, then press . Rotate  to scroll through the following choices:

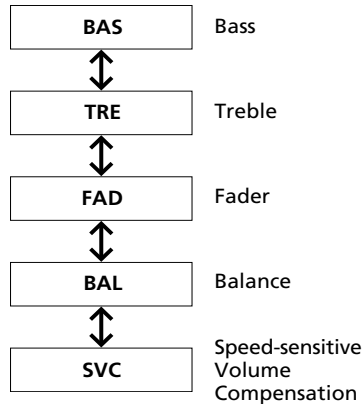
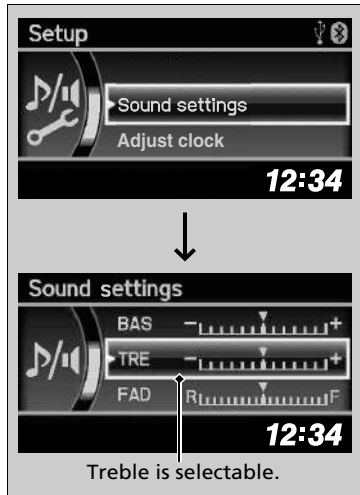

Adjusting the Sound

The SVC has four modes: **Off**, **Low**, **Mid**, and **High**. SVC adjusts the volume level based on the vehicle speed. As you go faster, audio volume increases. As you slow down, audio volume decreases.

Playing AM/FM Radio

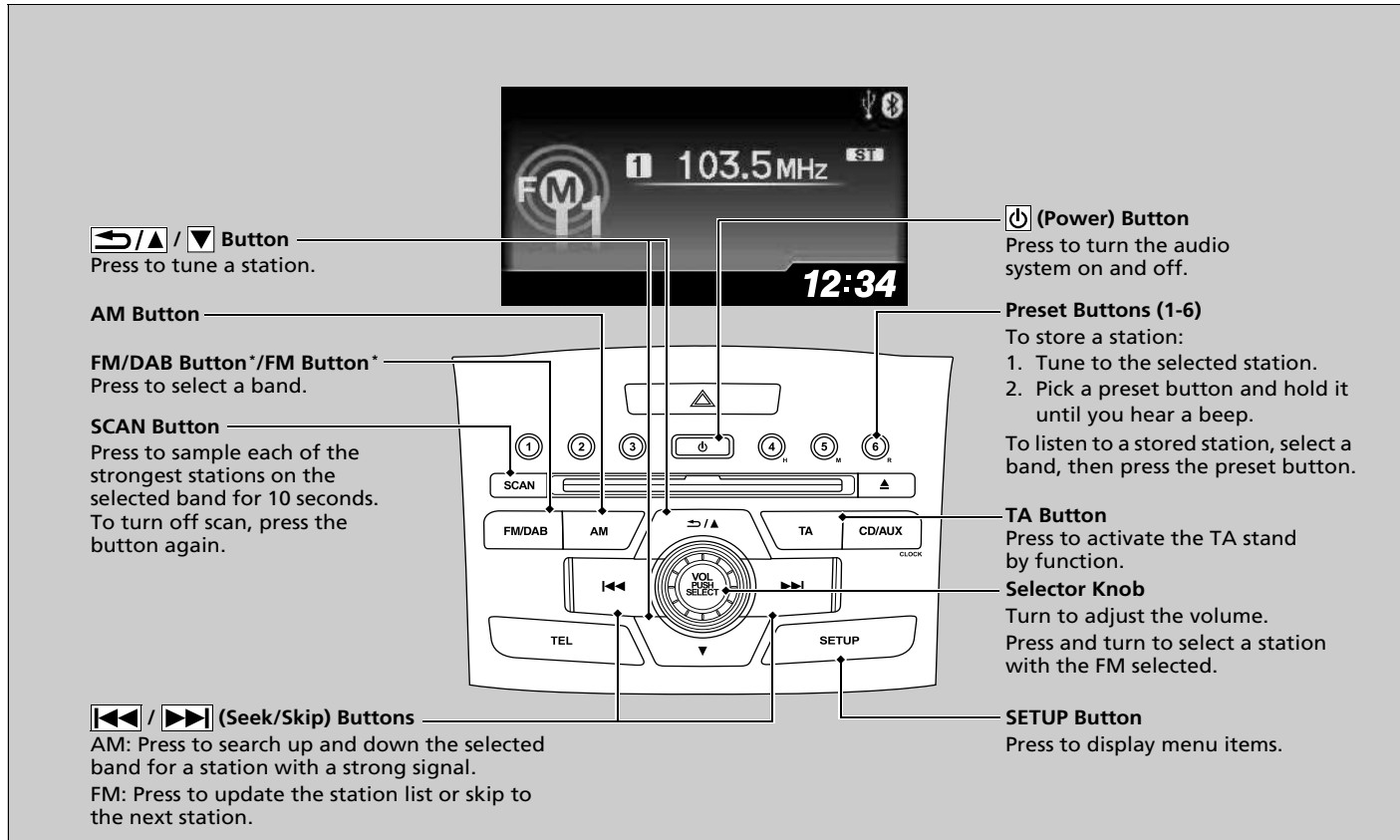

* Not available on all models

■ Radio Data System (RDS)

Provides convenient automated services related to your selected RDS capable FM station.

▶▶ Playing AM/FM Radio

The **ST** indicator appears on the display indicating stereo FM broadcasts.
Stereo reproduction in AM is not available.

Switching the Audio Mode

Press the **SOURCE** button on the steering wheel.

▶▶ **Audio Remote Controls** P. 245

You can store 12 AM stations and 12 FM stations into the preset button memory. AM has two types of frequencies LW and MW, and each lets you store six stations. FM1 and FM2 let you store six stations each.

▶▶ Radio Data System (RDS)

When you select an RDS capable FM station, the RDS automatically turns on, and the frequency display changes to the station name. However, when the signals of that station become weak, the display changes from the station name to the frequency.

■ To find an RDS station from Station List



1. Press while listening to a FM station.
2. Rotate to select the station, then press .

■ Manual Update

Updates your available station list at any time.

1. Press while listening to a FM station.
2. Rotate to select **Update list**, then press .

■ Available RDS functions

Alternative Frequency (AF):

Automatically changes the frequency of the same programme as you enter different regions.

Regional Programme (REG):

Keeps the same frequency of the stations within that region even if the signal gets weak.

News Programme (NEWS):

Automatically tunes to the news programme.

☒ Radio Data System (RDS)

While listening to a FM station on **Station list**, pressing (Seek/Skip) button changes the station.



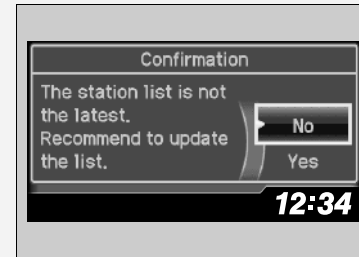

If the system find a station on **Station list**, a confirmation message for updating the list appears. Rotate to select **Yes**, then press to update the list.

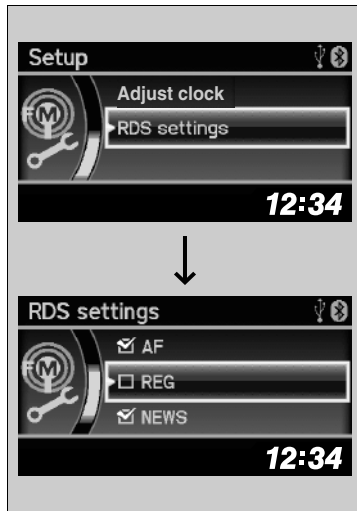

Continued

■ Setting the RDS functions



1. Press the **SETUP** button with the FM selected.
2. Rotate  to select **RDS settings** and press .
3. Each RDS function is displayed every time you rotate .
4. Press  to select a function.

▣ Radio Data System (RDS)

Turning the Alternative Frequency (AF) function on and off turns the RDS on and off.

Pressing  switches the function between on and off.

■ TA (Traffic announcement) button

TA standby function allows the system to stand by for traffic announcements in any mode. The last tuned station must be an RDS capable traffic programme station.

To turn the function on: Press the **TA** button. When a traffic announcement begins on your last tuned station, the system automatically switches to the FM mode. **TA-Information** appears on the display. The system returns to your last selected mode after the traffic announcement is finished.

If you want to go back to your last selected mode during the traffic announcement, press the **TA** button again.

To cancel the function: Press the **TA** button.

☒ Radio Data System (RDS)

TA

When you press the **TA** button, the **TA** indicator appears on the display.

If you press the **SCAN** button while the TA standby function is on, the system searches TP station only.

Pressing the **TA** button while the traffic announcement is on does not cancel the TA standby function.

Continued

■ **PTY (Programme type)/News interrupt function**

Allows the system to interrupt with a newscast in any mode. The last tuned station must be the NEWS PTY coded station.

To activate the function: Select **NEWS** from **RDS settings** and display the NEWS PTY before changing to other modes. When a newscast begins on your last tuned station, the system automatically switches to the FM mode.

➤ **Setting the RDS functions** P. 252

The system returns to your last selected mode if changed to another programme, or signal gets weak.

■ **PTY alarm**

The PTY code, ALARM is used for emergency announcements, such as natural disasters. When this code is received, **ALARM** appears on the display and the system interrupts your audio operation.

Playing DAB (Digital Audio Broadcasting)*

↶ / ▲ / ▼ Button

- Press to tune a DAB ensemble.
- Press and hold to search up and down top station in the DAB ensemble with a strong signal. The top station within this ensemble is selected.

SCAN Button

Press to sample each of the strongest stations on the station list for 10 seconds. To turn off scan, press the button again.

FM/DAB Button

Press to select a band.

◀◀ / ▶▶ (Seek/Skip) Buttons

Press to skip the station on the station list.

TP, NEWS, DAB, DAB-FM, 12:34

The DAB indicator appears on the display when the DAB band is selected.

⏻ (Power) Button

Press to turn the audio system on and off.

Preset Buttons (1-6)

To store a station:

1. Tune to the selected station.
2. Pick a preset button and hold it until you hear a beep.

To listen to a stored station, select a band, then press the preset button.

Selector Knob

Turn to adjust the volume. Press and turn to select a station on the station list or ensemble.



SETUP Button

Press to display menu items.

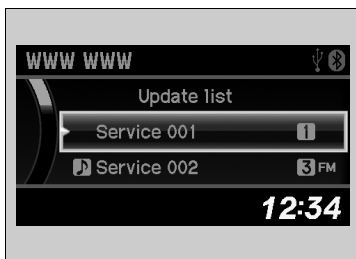

* Not available on all models

■ To find an DAB station from Service List or Ensemble List



1. Press  while selecting the DAB mode.
 2. Rotate  to select the station, then press .
- ▶ If you select **Update list**, the system update the station list.





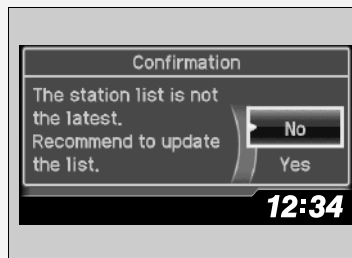

▣ To find an DAB station from Service List or Ensemble List

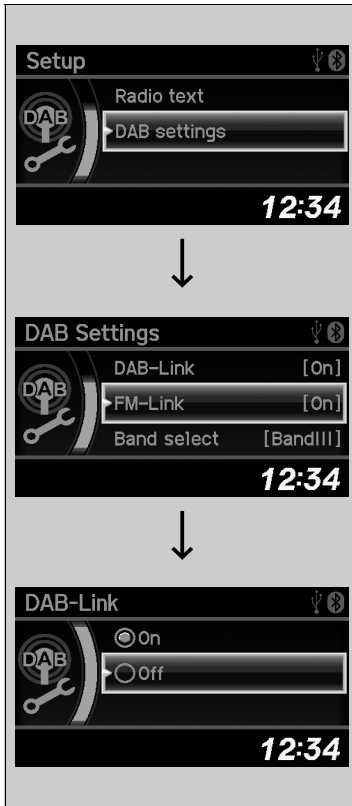
If the system cannot find a station, a confirmation message for updating the list appears. Rotate  to select **Yes**, then press  to update the list.



■ Setting the DAB functions



1. Press the **SETUP** button with the DAB selected.
2. Rotate  to select **DAB settings** and press .
3. Each DAB function is displayed every time you rotate .
4. Press  to select a function.
5. Rotate  to select a setting, then press .

Continued

DAB Settings

■ DAB-Link:

Automatically searches for the same station from Ensembles, and switches to it.

■ FM-Link:



If the system finds the same station from a FM band, it automatically switches the band.

■ Band select:

You can select specific bands. This can reduce the time to update the lists, and search for a station.

Radio Text



1. Press the **SETUP** button with the DAB selected.
2. Rotate  to select **Radio text** and press .

▶▶ Radio Text

The **TEXT** indicator appears on the display indicating radio text information.

Playing a CD

Your audio system supports audio CDs, CD-Rs and CD-RWs in either MP3 or WMA format. With the CD loaded, press the **CD/AUX** button.

SCAN Button
You will get a 10-second sampling of each song.

- Press to sample all tracks on the CD (all files in the current folder in MP3 or WMA).
- Press twice to sample the first file in each of the main folders (MP3 or WMA).
- To turn off scan, press and hold the button.

▶/▲/▼ Button
Press **▶/▲** to skip to the next folder, and **▼** to skip to the beginning of the previous folder in MP3 or WMA.

⏮/⏭ (Seek/Skip) Buttons
Press **⏮** or **⏭** to change tracks (files in MP3 or WMA).

⏻ (Power) Button
Press to turn the audio system on and off.

CD Slot
Insert a CD about halfway into the CD slot.

CD/AUX Button
Press to play a CD.

▲ (CD Eject) Button
Press to eject a CD.

Selector Knob
Turn to adjust the volume. Press and turn to select an item, then press to set your selection.

SETUP Button
Press to display menu items.

The diagram shows a car stereo unit with a digital display at the top. The display shows '256 999', 'Track AAA', '1:23"', 'Genre AAA', 'Artist AAA', and '12:34'. Below the display is a CD slot. The stereo has several buttons: 'SCAN', 'FM/DAB', 'AM', 'TA', 'CD/AUX', 'TEL', and 'SETUP'. A central knob is labeled 'VOL. FADER SELECT'. Six numbered callouts (1-6) point to specific buttons: 1 to SCAN, 2 to FM/DAB, 3 to AM, 4 to TA, 5 to CD/AUX, and 6 to the CD Eject button. A separate callout for the Power button points to a button on the right side of the unit.

How to Select a File from a Folder with the Selector Knob (MP3/WMA)

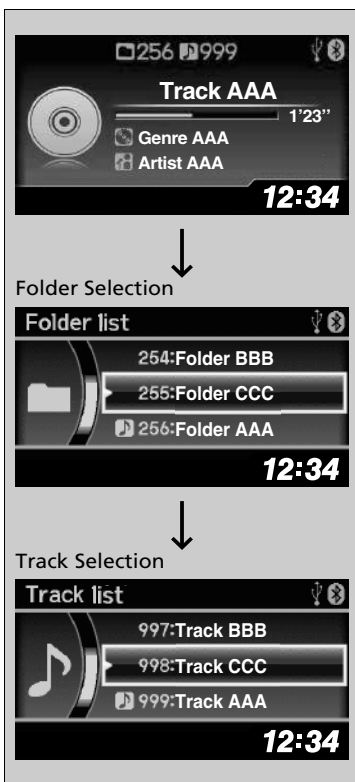

1. Press to switch the display to a folder list.

2. Rotate to select a folder.

3. Press to change the display to a list of files in that folder.

4. Rotate to select a file, then press .

▶▶ Playing a CD

NOTICE

Do not use CDs with adhesive labels. The label can cause the CD to jam in the unit.

WMA files protected by digital rights management (DRM) cannot be played.

The audio system displays **Unsupported**, then skips to the next file.

Text data appears on the display under the following circumstances:

- When you select a new folder, file, or track.
- When you change the audio mode to CD.
- When you insert a CD.

If you eject the CD but do not remove it from the slot, the system reloads the CD automatically after several seconds.

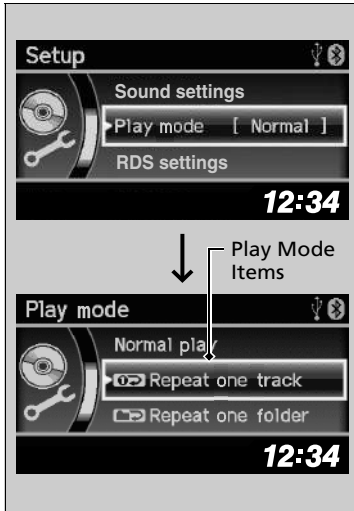

■ How to Select a Play Mode

You can select repeat and random modes when playing a track or file.



1. Press the **SETUP** button.

2. Rotate  to select **Play mode**, then press .

3. Rotate  to select a mode, then press .

■ To turn off a play mode

1. Press the **SETUP** button.

2. Rotate  to select **Play mode**, then press .

3. Rotate  to select **Normal play**, then press .

▶▶ How to Select a Play Mode

Play mode menu items

Normal play

Repeat one track: Repeats the current track/file(s).

Repeat one folder (MP3/WMA): Repeats all files in the current folder.

Random in folder (MP3/WMA): Plays all files in the current folder in random order.

Random all: Plays all tracks/files in random order.

Playing an iPod

Connect the iPod using your dock connector to the USB adapter cable, then press the **CD/AUX** button.

▶ **USB Adapter Cable** * P. 241

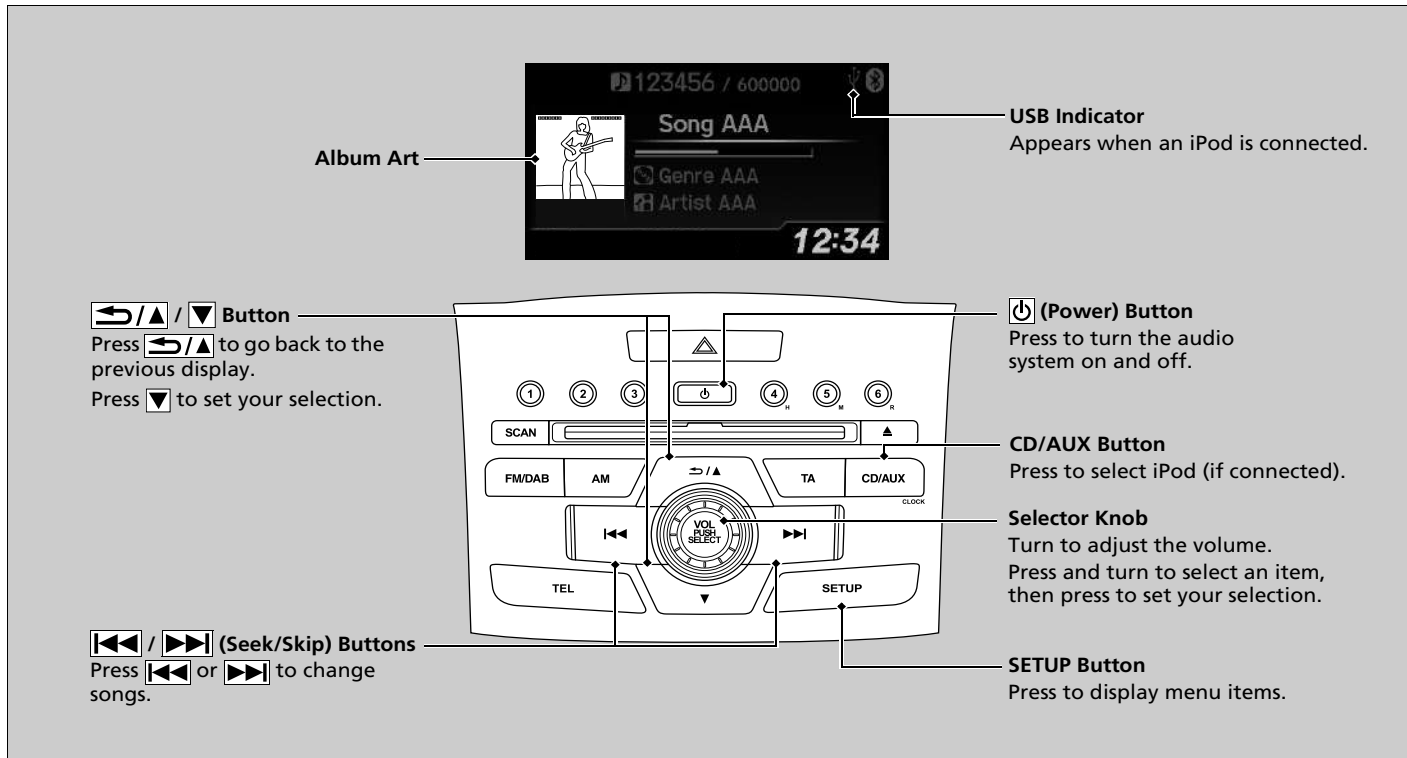

How to Select a File from the iPod Menu

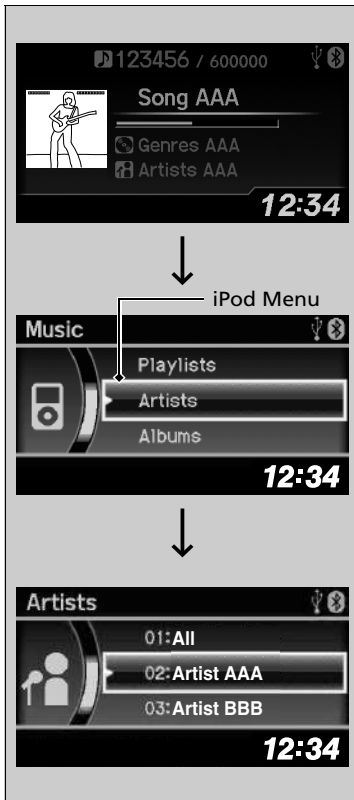

1. Press to display the iPod menu.

2. Rotate to select a menu.

3. Press to display the items on that menu.

4. Rotate to select an item, then press .

▶▶ Playing an iPod

Available operating functions vary on models or versions. Some functions may not be available on the vehicle's audio system.

If there is a problem, you may see an error message on the i-multi-information display.

iPod/USB Flash Drive P. 316

How to Select a Play Mode

You can select repeat and shuffle modes when playing a track.

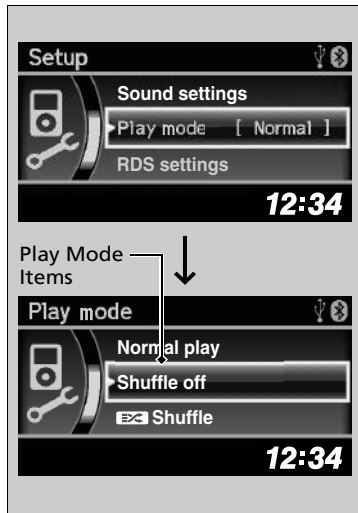

1. Press the **SETUP** button.

2. Rotate to select **Play mode**, then press .

3. Rotate to select a mode, then press .

To turn off a play mode

1. Press the **SETUP** button.

2. Rotate to select **Play mode**, then press .

3. Rotate to select **Normal play**, then press .

How to Select a Play Mode

Play mode menu items

Normal play

Shuffle off: Turns off the shuffle mode.

Shuffle: Plays all available tracks in a selected list (playlists, artists, albums, songs, genres, or composers) in random order.

Shuffle albums: Plays all available albums in a selected list (playlists, artists, albums, songs, genres, or composers) in random order.

Repeat off: Turns off the repeat mode.

Repeat one track: Repeats the current track.

Playing a USB Flash Drive

Your audio system reads and plays sound files on a USB flash drive in either MP3, WMA or AAC*1 format.

Connect your USB flash drive to the USB adapter cable, then press the **CD/AUX** button.

🔌 **USB Adapter Cable** * P. 241

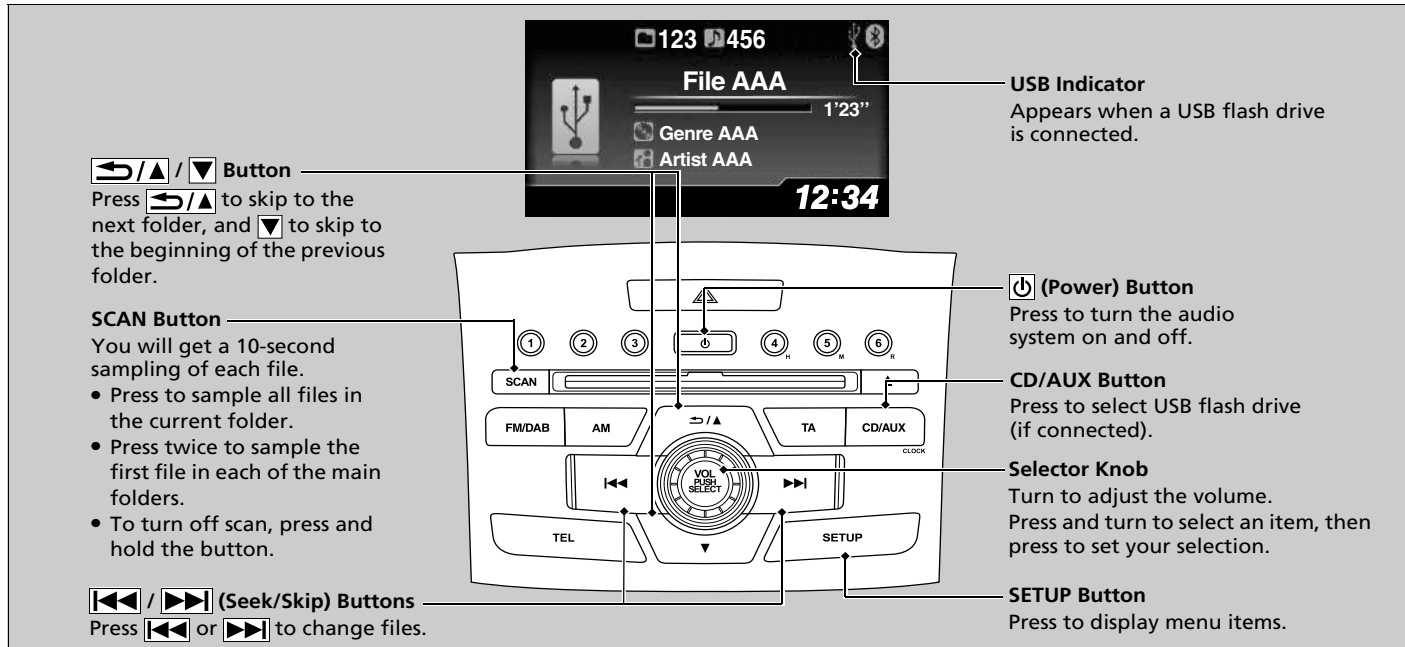

*1: Only AAC format files recorded with iTunes are playable on this unit.

* Not available on all models

How to Select a File from a Folder with the Selector Knob

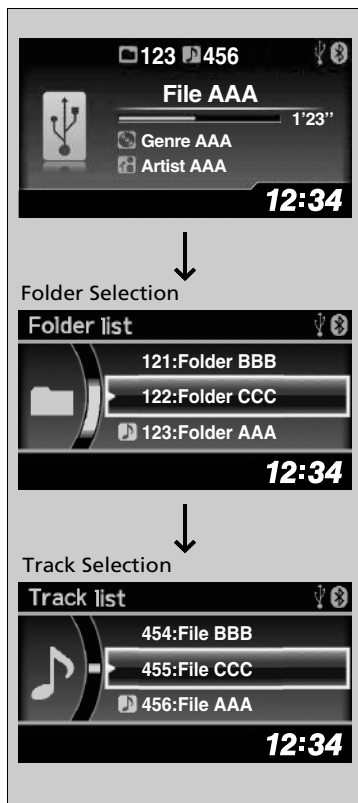

1. Press to switch the display to a folder list.

2. Rotate to select a folder.

3. Press to change the display to a list of files in that folder.

4. Rotate to select a file, then press .

▶▶ Playing a USB Flash Drive

Use the recommended USB flash drives.

General Information on the Audio System
P. 319

Files in WMA format protected by digital rights management (DRM) are not played.

The audio system displays **Unplayable file**, and then skips to the next file.

If there is a problem, you may see an error message on the i-multi-information display.

iPod/USB Flash Drive P. 316

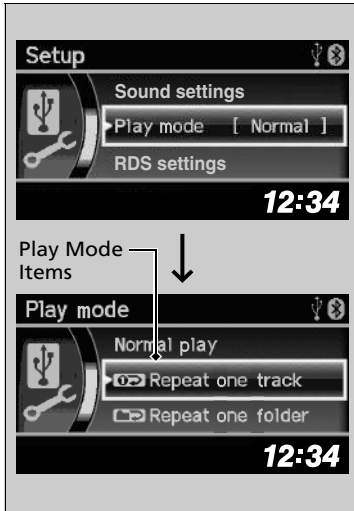

■ How to Select a Play Mode

You can select repeat and random when playing a file(s).



1. Press the **SETUP** button.

2. Rotate  to select **Play mode**, then press .

3. Rotate  to select a mode, then press .

■ To turn off a play mode

1. Press the **SETUP** button.

2. Rotate  to select **Play mode**, then press .

3. Rotate  to select **Normal play**, then press .

▣ How to Select a Play Mode

Play mode menu items

Normal play

Repeat one track: Repeats the current file.

Repeat one folder: Repeats all files in the current folder.

Random in folder: Plays all files in the current folder in random order.

Random all: Plays all files in random order.

Playing *Bluetooth*® Audio

Your audio system allows you to listen to music from your *Bluetooth*-compatible phone.

This function is available when the phone is paired and connected to the vehicle's Hands-Free Telephone (HFT) system.

➔ **Phone Setup** P. 346

▶▶ Playing *Bluetooth*® Audio

Not all *Bluetooth*-enabled phones with streaming audio capabilities are compatible with the system.

You can find an approved phone by visiting:

- Europe:
<http://www.hondahandsfree.com/>.

In some countries, it may be illegal to perform some data device functions while driving.

If more than one phone is paired to the system, there will be a delay before the system begins to play.

Some functions may not be available on some devices.

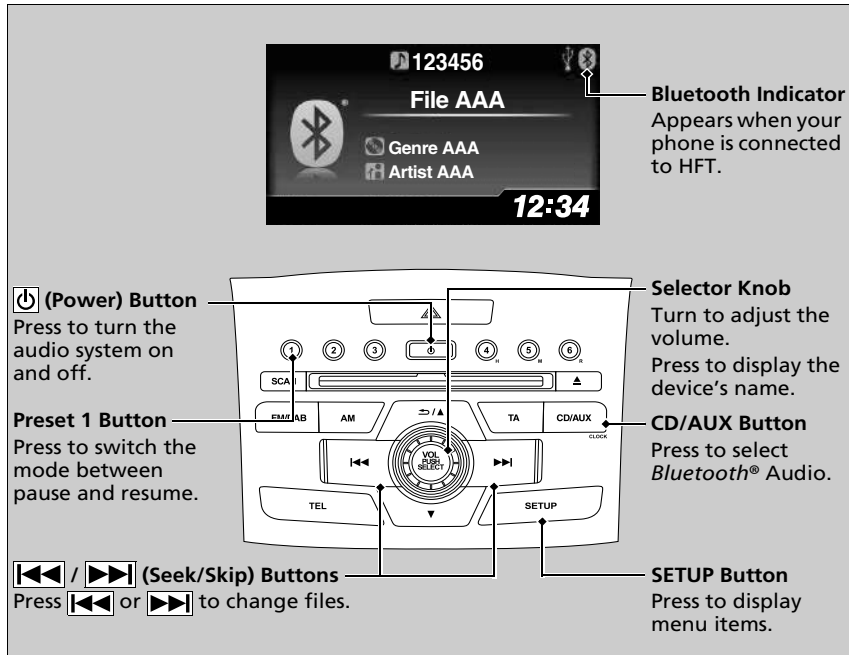

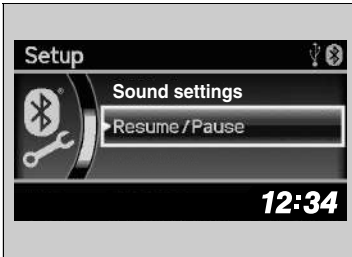

■ To Play *Bluetooth*® Audio Files



1. Make sure that your phone is paired and connected to the system.
2. Press the **CD/AUX** button.

If the phone is not recognized, another HFT-compatible phone, which is not compatible for *Bluetooth*® Audio, may already be connected.

■ To pause or resume a file

1. Press the **SETUP** button.
2. Rotate  to select **Resume/Pause**, then press .

Each time you press , the setting switches between pause and resume.

▶▶ To Play *Bluetooth*® Audio Files

To play the audio files, you may need to operate your phone. If so, follow the phone maker's operating instructions.



The pause function may not be available on some phones.

If any audio device is connected to the auxiliary input jack, you may need to press the **CD/AUX** button repeatedly to select the *Bluetooth*® Audio system.

Switching to another mode pauses the music playing from your phone.

Audio System Basic Operation

Audio system with two displays

To use the audio system function, the ignition switch must be in ACCESSORY  or ON *1.

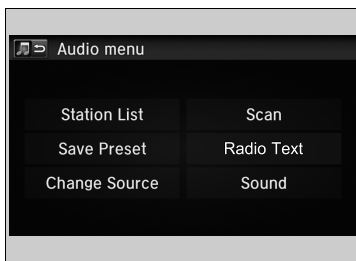
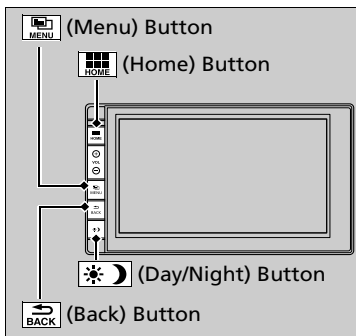





 (Home) Button: Press to go to the home screen.

➤ **Switching the Display** P. 272

 (Menu) Button: Press to select any mode. The available mode includes **Change Source**, **Station List**, **Save Preset**, **Radio Text**, **Music Search**, and play modes. Play modes can be also selected from **Scan**, **Random/Repeat**, and so on.

 (Back) Button: Press to go back to the previous display when it is displayed.

 (Day/Night) button: Press to change the audio/information screen brightness.

Press the  button once and select  or  to make an adjustment.

▶ Each time you press the  button, the mode switches among the daytime mode, nighttime mode and off mode.

➤ Audio System Basic Operation

Audio Menu Items

➤ **Station List** P. 291

➤ **How to Select a File from the Music Search List (MP3/WMA/AAC)** P. 297, 303

➤ **Scan** P. 294

➤ **How to Select a Play Mode** P. 298, 301, 304

When the battery has been reconnected or replaced, the next start-up may take a few minutes for the audio system to start. Wait a few moments while the system is starting up.

Press and hold the  (Power) button for approximately 10 seconds to reset the system. When the system is reset and started up, you are required to input the password.

➤ **Audio System Theft Protection** P. 244

*1: Models with the keyless access system have an **ENGINE START/STOP** button instead of an ignition switch.

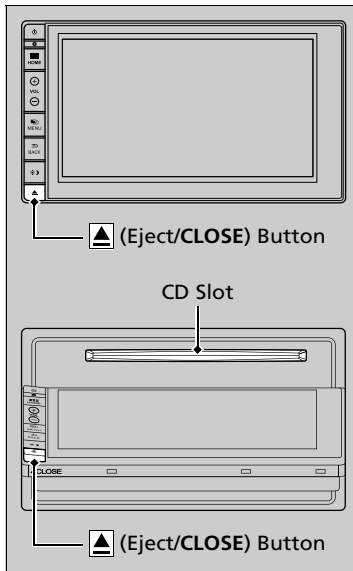
Models with navigation system**How to access the disc slot**

Press the  (Eject/**CLOSE**) button to open the screen.

▶ The screen folds back, and the CD slot appears.

Press the  (Eject/**CLOSE**) button to return the screen to the upright position.

How to access the disc slot

If you eject the CD but do not remove it from the slot, the system reloads the CD automatically after several seconds.

Do not use the folded down screen as a tray.

Models without keyless access system

You cannot open the screen when the key is in the ignition switch.

Models with keyless access system

You cannot open the screen when the power mode is in VEHICLE OFF.

Audio/Information Screen

Displays the audio status and wallpaper. From this display, you can go to various setup options.

■ Switching the Display

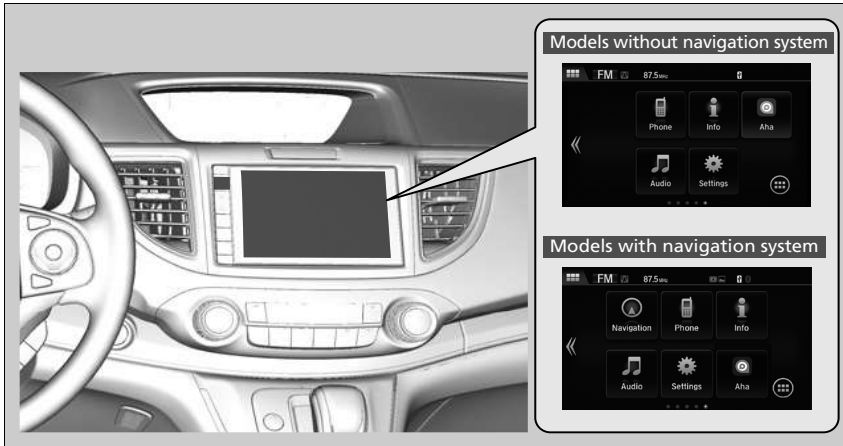

Press the  button to go to the home screen.
Select **Phone**, **Info**, **Audio**, **Settings**, or **Navigation***.

■ Phone

Displays the HFT information.

 **Hands-Free Telephone System** P. 364

■ Info

To see all available information, **Trip Computer**, **Clock/Wallpaper**, or **System/Device Information**, press the  button.

Trip Computer:

- **Current Drive** tab: Displays the current trip information.
- **History of Trip A** tab: Displays information for the three previous drives. The information is stored every time you reset Trip A.

Clock/Wallpaper:

Displays the clock and wallpaper.

System/Device Information:

- **Version Information**: Displays the software version of the audio system.
- **USB Device Information**: Displays the memory usage of the USB device.
- **USB Device Change**: Connects or disconnects USB device to this audio system.

■ Audio

Displays the current status.

■ Settings

Enters the customizing menu screen.

 **Customized Features*** P. 323

■ Navigation*

Displays the navigation screen.

 **Refer to the Navigation System Manual**

* Not available on all models

■ Changing the Home Screen Icon Layout

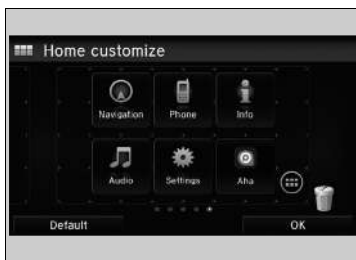

1. Press the  button.
2. Select **Settings**.
3. Select **System**.
4. Select the **HOME** tab.
5. Select **Home icon position**.
6. Select and hold the icon then, drag it to the desired position.

Wallpaper Setup

You can change, store, and delete the wallpaper on the audio/information screen.

Import wallpaper

You can import up to five images, one at a time, for wallpaper from a USB flash drive.

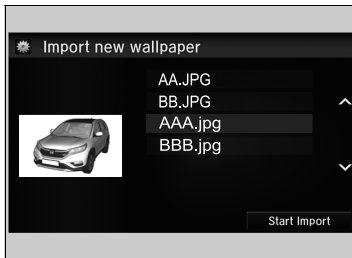

1. Connect the USB flash drive to the USB port.

▶ **USB Ports*** P. 242

2. Select **Settings**.

3. Select **Info**.

4. Select **Clock/Wallpaper Type**, then open the **Wallpaper** tab.

5. Select **Add New**.

▶ The picture name is displayed on the list.

6. Select a desired picture.

▶ The preview is displayed on the left side on the screen.

7. Select **Start Import** to save the data.

▶ The display will return to the wallpaper list.

Wallpaper Setup

- The wallpaper you set up on **Clock Wallpaper/Type** cannot be displayed on the i-multi-information display.
- When importing wallpaper files, the image must be in the USB flash drive's root directory. Images in a folder cannot be imported.
- The file name must be fewer than 64 characters.
- The file format of the image that can be imported is BMP (bmp) or JPEG (jpg).
- The individual file size limit is 5 MB.
- The maximum image size is 4,096 × 4,096 pixels. If the image size is less than 800 × 480 pixels, the image is displayed in the middle of the screen with the extra area appearing in black.
- If the USB flash drive does not have any pictures, the **No files detected** message appears.

* Not available on all models

Continued

■ Select wallpaper

1. Select **Settings**.
2. Select **Info**.
3. Select **Clock/Wallpaper Type**, then open the **Wallpaper** tab.
 - ▶ The screen changes to the wallpaper list.
4. Select a desired wallpaper.
 - ▶ The preview is displayed on the left side on the screen.
 - ▶ The pop-up menu appears on the screen.
5. Select **Set**.
 - ▶ The display will return to the wallpaper list.

■ Delete wallpaper

1. Select **Settings**.
2. Select **Info**.
3. Select **Clock/Wallpaper Type**, then open the **Wallpaper** tab.
 - ▶ The screen changes to the wallpaper list.
4. Select a wallpaper that you want to delete.
 - ▶ The preview is displayed on the left side on the screen.
 - ▶ The pop-up menu appears on the screen.
5. Select **Delete**.
 - ▶ A confirmation message appears on the screen.
6. Select **Yes** to delete completely.
 - ▶ The display will return to the wallpaper list.

Wallpaper Setup

From the pop-up menu, select **Preview** to see a preview at full-size screen.

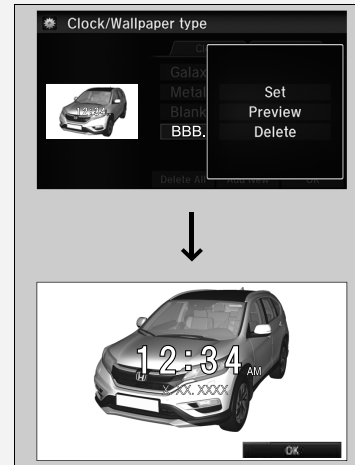

To go back to the previous screen, select **OK**, or press the  (**BACK**) button.



When the file size is large, it takes a while to be previewed.

To delete all wallpapers you add, select **Delete All**, then **Yes**.

■ Home Screen

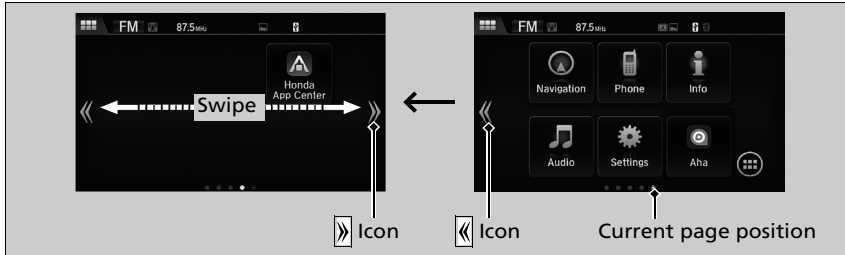
■ To change to a next screen



Selecting  or , or swiping the screen left or right changes to the next screen.

▶▶ To change to a next screen

The home screen has 5 pages (fixed). You cannot add any more pages.

Continued

■ To use apps or widgets

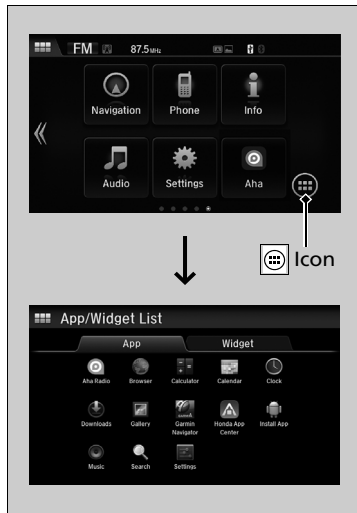

1. Select .
 - ▶ The **App/Widget List** screen appears.
2. Select the app or widget you want to use.

Preinstall app list:

- **Aha Radio**: Starts up Aha app.
- **Browser**: Displays the web browser utilized by smartphone and Wi-Fi connection.
- **Calculator**: Displays calculator.
- **Calendar**: Displays calendar.
- **Clock**: Displays clock.
- **Downloads**: Displays the data downloaded from the web browser and so on.
- **Gallery**: Displays the image list stored in the audio system.
- **Garmin Navigator**: Starts up navigation app.
- **Honda App Center**: Displays Honda App Center.
- **Install App**: Installs and updates app stored in the USB flash drive. However, you can install and update app only through Honda App Center.
- **Music**: Displays the music list stored in the audio system.
- **Search**: Displays various retrieval screens.
- **Settings**: Displays the Android setting screen.

▶▶ To use apps or widgets

Select and hold a selected app or widget to add that app's or widget's shortcut on the home screen.

If preinstall apps do not startup normally, try **Factory Data Reset**.

In case those apps still do not startup normally even after **Factory Data Reset**, contact a dealer.

If you perform **Factory Data Reset**, it may reset all the settings to their factory default.

▶▶ **Defaulting All the Settings** P. 339

■ To add app or widget icons on the home screen

App or widget icons can be added on the home screen.

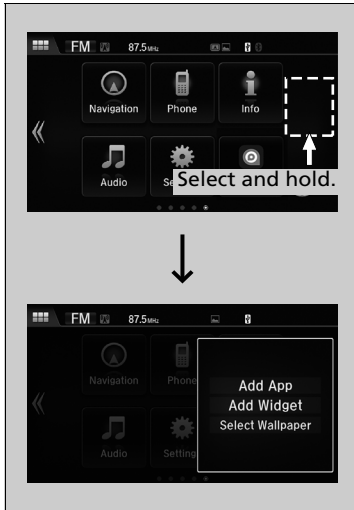

1. Select and hold empty space on the home screen.
 - ▶ The pop-up menu appears on the screen.
2. Select **Add App** or **Add Widget**.
 - ▶ The **Add App/Widget** screen appears.

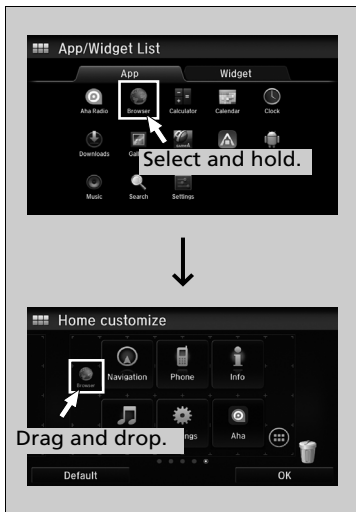

3. Select and hold an app or widget icon you want to add.
 - ▶ The screen switches to the **Home customize** screen.
4. Drag and drop the icon to where you want it to be.
5. Select **OK**.
 - ▶ The screen will return to the home screen.

■ To move icons on the home screen

You can change location on the home screen.

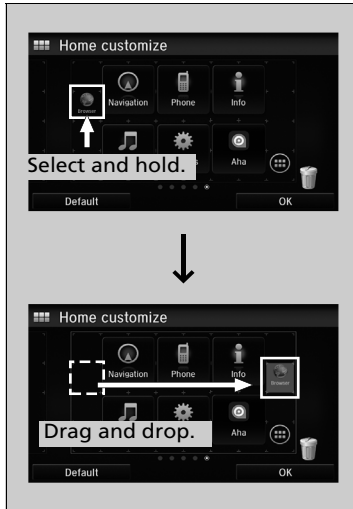

1. Select and hold an icon.
 - ▶ The screen switches to the **Home customize** screen.
2. Drag and drop the icon to where you want it to be.
3. Select **OK**.
 - ▶ The screen will return to the home screen.

☒ To move icons on the home screen

You can also move the **Phone**, **Info**, **Audio**, **Settings**, and **Navigation*** icons in the same manner.

* Not available on all models

Continued

■ To delete icons on the home screen

You can delete the icons on the home screen.

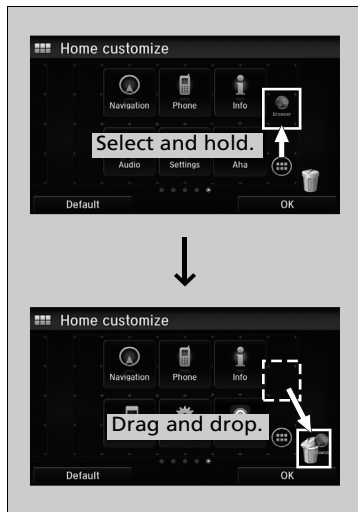

1. Select and hold an icon.
 - ▶ The screen switches to the **Home customize** screen.
2. Drag and drop the icon you want to delete to waste basket icon.
 - ▶ The icon is deleted.
3. Select **OK**.
 - ▶ The screen will return to the home screen.

❏ To delete icons on the home screen

You cannot delete the **Phone**, **Info**, **Audio**, **Settings**, and **Navigation*** icons.

Apps or widgets will not be deleted by deleting the icon on the home screen.

■ To change a wallpaper of the home screen

You can change a wallpaper of the home screen.

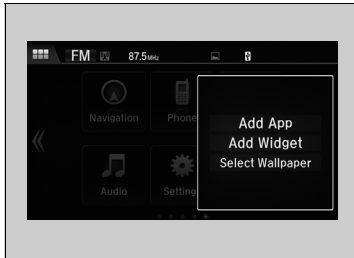

1. Select and hold empty space on the home screen.
 - ▶ The pop-up menu appears on the screen.
2. Select **Select Wallpaper**.
 - ▶ The pop-up menu appears on the screen.

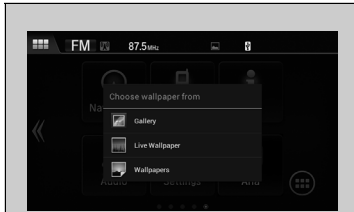

3. Select an app for selecting wallpapers.
4. Select the wallpaper you want to change.
5. Select **Set wallpaper**.
 - ▶ The wallpaper is changed, then the screen will return to the home screen.





Status Area



Swipe the upper area of the screen.

▶ The status area appears.

Select an item to see the details.

Select  or swipe up the  icon to close the area.

■ Changing the Screen Interface

You can change the screen interface design.

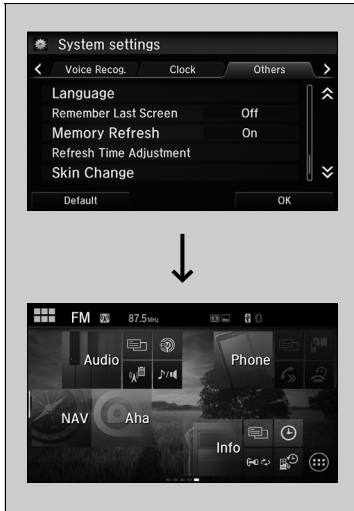

1. Press the  button.
2. Select **Settings**.
3. Select **System**.
4. Select the **Others** tab.
5. Select **Skin Change**.
6. A confirmation message appears on the screen. Select **Yes**.

▶▶ Changing the Screen Interface

You need to reboot the system after changing the interface design. Wait a few moments while the system is starting up.

You can change the wallpaper on the audio/information screen.

▶ **Wallpaper Setup** P. 275

If you change the screen interface, some of the setting items will change.

▶ **Customized Features*** P. 323

* Not available on all models

Closing Apps

You can close apps running in the background on the system.

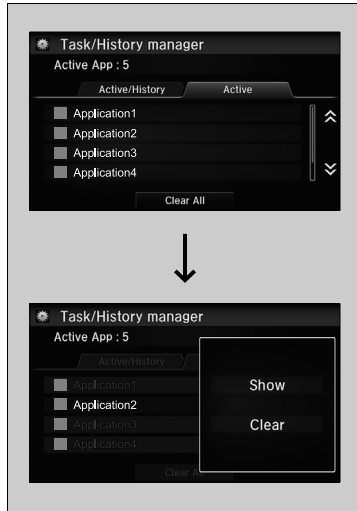

1. Press and hold the  button.
2. Select the **Active** tab.
 - ▶ If you select the **Active/History** tab, you can close the apps that are currently running and delete the app activity history simultaneously.
3. Select an app you want to close.
4. Select **Clear**.
 - ▶ The display will return to the app list.

Closing Apps

If you leave the apps used open in the background, some apps may stop operating properly next time using them.
If this happens close unused apps.

To close all apps on the system, select **Clear All**, then **Yes**.

Adjusting the Sound

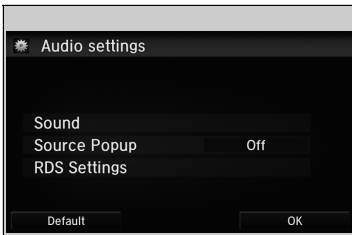

1. Press the  button.
2. Select **Settings**.
3. Select **Audio**.
4. Select **Sound**.

Select a tab from the following choices:
BASS, TREBLE, FADER, BALANCE, SUBW
 (Subwoofer)*, **Speed Volume**
Compensation (SVC)

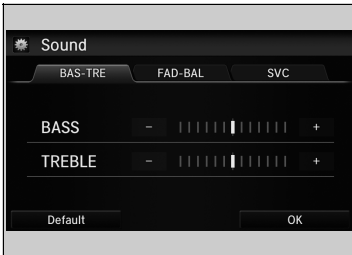

Adjusting the Sound

The SVC has four modes: **Off, Low, Mid,** and **High**. SVC adjusts the volume level based on the vehicle speed. As you go faster, audio volume increases. As you slow down, audio volume decreases.

* Not available on all models

Display Setup

You can change the brightness or colour theme of the audio/information screen.

■ Changing the Screen Brightness

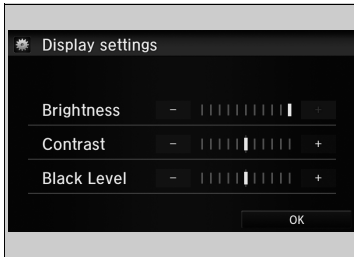

1. Press the  button.
2. Select **Settings**.
3. Select **System**.
4. Select the **Display** tab.
5. Select **Display settings**.
6. Select the setting you want.
7. Select **OK**.

■ Changing the Screen's Colour Theme

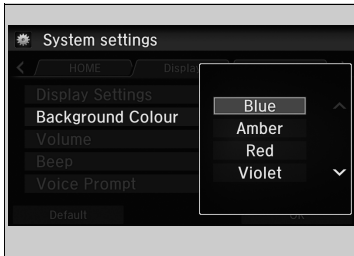

1. Press the  button.
2. Select **Settings**.
3. Select **System**.
4. Select the **Display** tab.
5. Select **Background Colour**.
6. Select the setting you want and select it again.
 - ▶ A confirmation message appears on the screen. Select **Yes** to reboot the system.

▶▶ Changing the Screen Brightness

You can change the **Contrast** and **Black Level** settings in the same manner.

▶▶ Changing the Screen's Colour Theme

Reboot may take a few minutes. If you default the **System settings** when the colour theme is changed from its default colour, the system reboots.

➤ **Customized Features*** P. 323

Selecting an Audio Source

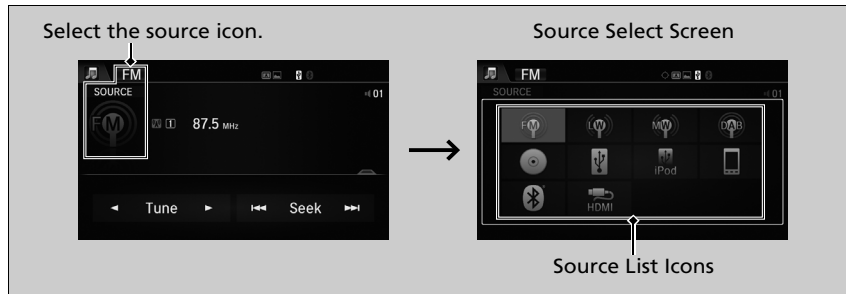

Select the current source icon, then select an icon on the source list to switch the audio source.

Limitations for Manual Operation

Certain manual functions are disabled or inoperable while the vehicle is in motion. You cannot select a grayed-out option until the vehicle is stopped.

▶▶ Selecting an Audio Source

If you startup preinstalled audio apps, **AUDIO Apps** is displayed on the upper left of the screen. These preinstalled apps cannot be displayed on the source select screen. You can startup those audio apps from **App/Widget List**.

Playing AM/FM Radio

The diagram illustrates the car's audio system interface. At the top, the **i-Multi-Information Display** shows 'FM 1 103.5MHz ST' and the time '12:34'. Below it, the **Audio/Information Screen** displays 'FM SOURCE 87.5 MHz' and '01'. The screen includes **Tune** and **Seek** icons. The physical control panel on the left features a **(Power) Button**, **VOL (Volume) Buttons**, **(Menu) Button**, **(Back) Button**, and **Tune Icons**. The **Open/Close Icon** is located on the right side of the screen.

(Power) Button
Press to turn the audio system on and off.

VOL (Volume) Buttons
Press to adjust the volume.

(Menu) Button
Press to display the menu items.

(Back) Button
Press to go back to the previous display.

Tune Icons
Select ◀ or ▶ to tune the radio frequency.

i-Multi-Information Display

Audio/Information Screen

Open/Close Icon^{*1}
Displays/hides the detailed information.

Seek Icons
Select ◀◀ or ▶▶ to search up and down the selected band for a station with a strong signal.

*1: Some or all of the lists may not be displayed.

■ Preset Memory

To store a station:

1. Tune to the selected station.
2. Press the  button.
3. Select **Save Preset**.
4. Select the preset number for the station you want to store.

■ Station List

Lists the strongest stations on the selected band.

1. Press the  button.
2. Select **Station List**.
3. Select the station.

■ Manual update

Updates your available station list at any time.

1. Press the  button.
2. Select **Station List**.
3. Select **Update List**.

■ Scan

Samples each of the strongest stations on the selected band for 10 seconds.

1. Press the  button.
2. Select **Scan**.

To turn off scan, select **Cancel Scan**.

▶▶ Preset Memory

The **ST** indicator appears on the display indicating stereo FM broadcasts.
Stereo reproduction in AM is not available.

Switching the Audio Mode

Press the **SOURCE** button on the steering wheel or select **SOURCE** on the screen.

▶▶ **Audio Remote Controls** P. 245

You can also switch the mode by selecting **Change Source** on the **Audio menu** screen.

You can store 6 AM stations and 12 FM stations into preset memory.

■ Radio Data System (RDS)

Provides text data information related to your selected RDS-capable FM station.

■ To find an RDS station from Station List

1. Press the  button while listening to an FM station.
2. Select **Station List**.
3. Select the station.

■ Manual update

Updates your available station list at any time.

1. Press the  button while listening to an FM station.
2. Select **Station List**.
3. Select **Update List**.

■ Radio text

Displays the radio text information of the selected RDS station.

1. Press the  button.
2. Select **Radio Text**.

■ Scan

Samples each of the strongest stations on the selected band for 10 seconds.

1. Press the  button.
2. Select **Scan**.

To turn off scan, select **Cancel Scan**.

☒ Radio Data System (RDS)

When you select an RDS-capable FM station, the RDS automatically turns on, and the frequency display changes to the station name. However, when the signals of that station become weak, the display changes from the station name to the frequency.

Playing DAB (Digital Audio Broadcasting)

The diagram illustrates the car's audio system interface for playing DAB. It features a central **Audio/Information Screen** and a smaller **i-Multi-Information Display** at the top. The main screen shows the DAB source as 'AAA' with a signal strength of '01'. Below the screen are **Ensemble Icons** (left and right arrows) and **Service Icons** (double left and right arrows). The physical buttons on the left side of the unit include a Power button, Volume buttons, Menu button, and Back button. The i-Multi-Information Display shows 'DAB 1', a frequency placeholder '2', a website address 'WWW...', and the time '12:34'.

(Power) Button — Press to turn the audio system on and off.

VOL (Volume) Buttons — Press to adjust the volume.

(Menu) Button — Press to display the menu items.

(Back) Button — Press to go back to the previous display.

Ensemble Icons — Select ◀ or ▶ to tune the frequency.

i-Multi-Information Display

Audio/Information Screen

Open/Close Icon^{*1} — Displays/hides the detailed information.

Service Icons — Select ◀◀ or ▶▶ to search up and down the selected band for a station with a strong signal.

*1:Some or all of the lists may not be displayed.

■ Preset Memory

Stores a station:

1. Tune to the selected station.
2. Press the  button.
3. Select **Save Preset**.
4. Select the preset number for the station you want to store.

■ Ensemble List

Lists the strongest stations.

1. Press the  button.
2. Select **Ensemble List**.
3. Select the station.

■ Manual update

Updates your available station list at any time.

1. Press the  button.
2. Select **Ensemble List**.
3. Select **Update List**.

■ Scan

Samples each of the strongest stations on the selected band for 10 seconds.

1. Press the  button.
2. Select **Scan**.
3. Select **Scan Ensemble** or **Scan Service**.

To turn off scan, select **Cancel Scan**.

▶▶ Playing DAB (Digital Audio Broadcasting)

Switching the Audio Mode

Press the **SOURCE** button on the steering wheel or select **SOURCE** on the screen.

 **Audio Remote Controls** P. 245

You can also switch the mode by selecting **Change Source** on the **Audio menu** screen.

You can store 12 DAB stations into preset memory.

■ Radio text

Displays the radio text information of the selected DAB station.

1. Press the  button.
2. Select **Radio Text**.

Models with navigation system

Playing a CD

Your audio system supports audio CDs, CD-Rs, and CD-RWs in either MP3 or WMA, or AAC*1 format. With the CD loaded, select the CD mode.

The diagram illustrates the audio system's interface for playing a CD. It features two main displays: the **i-Multi-Information Display** at the top and the **Audio/Information Screen** below it. The i-Multi-Information Display shows track information for 'Track AAA', including a CD icon, track number '01', genre 'Genres AAA', and artist 'Artists AAA'. The Audio/Information Screen displays 'CD' mode, a track list with '01 BBB' selected, and playback controls. The interface is controlled by a vertical panel of buttons on the left, including Power, Volume, Menu, Back, and Eject/Close buttons. Track icons for folder and track navigation are also shown.

(Power) Button — Press to turn the audio system on and off.

VOL (Volume) Buttons — Press to adjust the volume.

(Menu) Button — Press to display the menu items.

(Back) Button — Press to go back to the previous display.

(Eject/Close) Button — Press to eject a CD.

Folder Icons — Select to skip to the next folder, and to skip to the beginning of the previous folder in MP3, WMA, or AAC.

i-Multi-Information Display

Audio/Information Screen

Open/Close Icon*2 — Displays/hides the detailed information.

Track Icons — Select or to change tracks (files in MP3, WMA, or AAC). Select and hold to move rapidly within a track.

*1: Only AAC format files recorded with iTunes are playable on this unit.

*2: Some or all of the lists may not be displayed.

How to Select a File from the Music Search List (MP3/WMA/AAC)



1. Press the  button and select **Music Search**.

2. Select a folder.

3. Select a track.

▶▶▶ Playing a CD

NOTICE

Do not use CDs with adhesive labels. The label can cause the CD to jam in the unit.

WMA files protected by digital rights management (DRM) cannot be played.

The audio system displays **Unplayable File**, then skips to the next file.

Text data appears on the display under the following circumstances:

- When you select a new folder, file, or track.
- When you change the audio mode to CD.
- When you insert a CD.

If you eject the CD but do not remove it from the slot, the system reloads the CD automatically after several seconds.

Continued

How to Select a Play Mode

You can select scan, repeat, and random modes when playing a track or file.



1. Press the  button.
2. Select **Scan** or **Random/Repeat**.
3. Select a mode.

To turn off a play mode

1. Press the  button.
2. Select the mode you want to turn off.

How to Select a Play Mode

Play Mode Menu Items

Scan

Scan Folders (MP3/WMA/AAC): Provides 10-second sampling of the first file in each of the main folders.

Scan Tracks: Provides 10-second sampling of all tracks on the CD (all files in the current folder in MP3, WMA, or AAC).

Random/Repeat

Repeat Folder (MP3/WMA/AAC): Repeats all files in the current folder.

Repeat Track: Repeats the current track/file.

Random in Folder (MP3/WMA/AAC): Plays all files in the current folder in random order.

Random All Tracks: Plays all tracks/files in random order.

Playing an iPod

Connect the iPod using your USB connector to the USB port, then select the iPod mode.

📖 **USB Ports** * P. 242

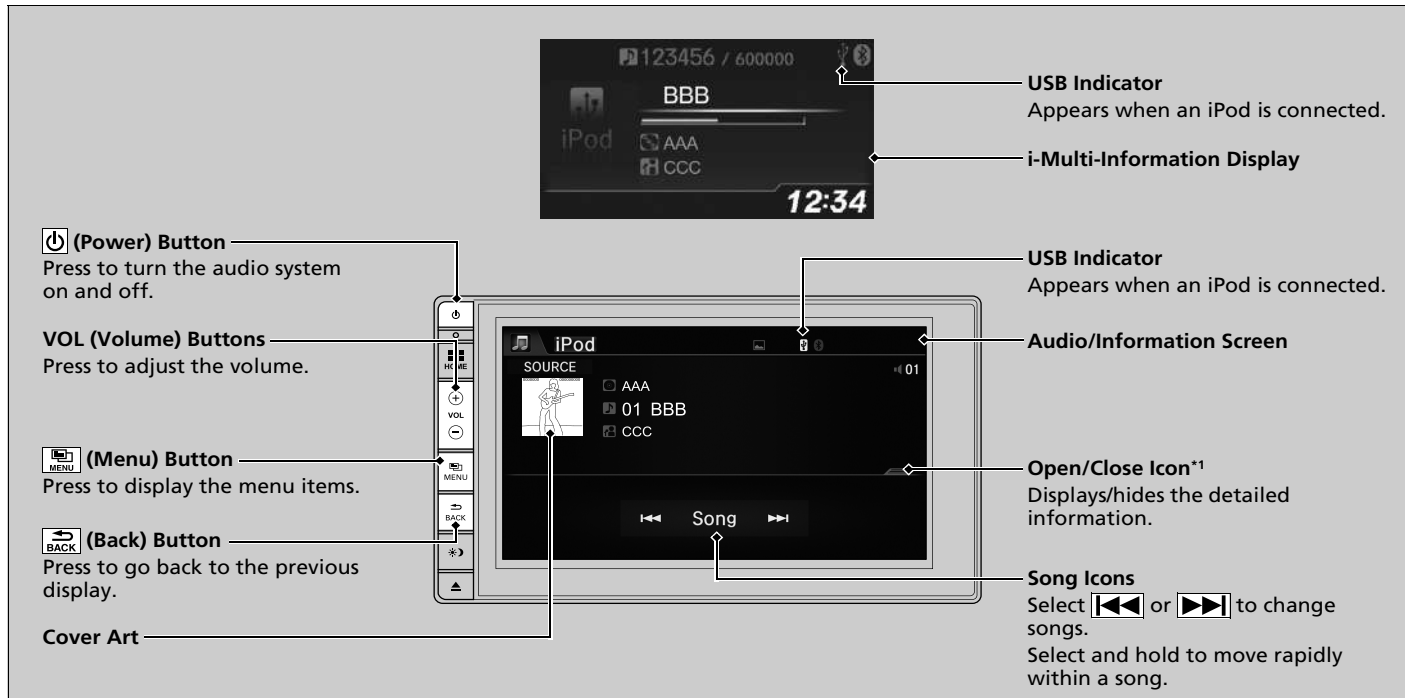

* 1: Some or all of the lists may not be displayed.

* Not available on all models

How to Select a Song from the Music Search List

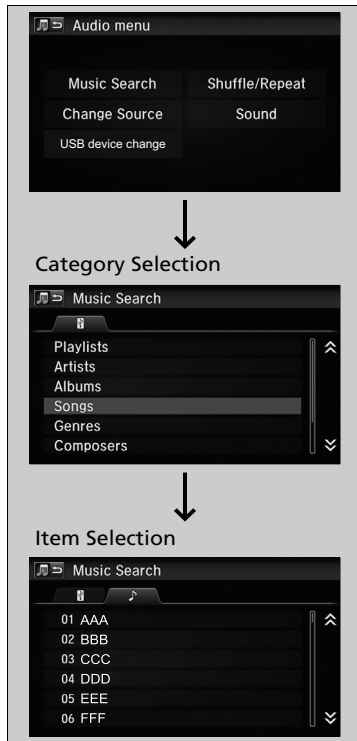

1. Press the  button and select **Music Search**.

2. Select the items on that menu.

▶▶ Playing an iPod

Available operating functions vary on models or versions. Some functions may not be available on the vehicle's audio system.

If there is a problem, you may see an error message on the audio/information screen.

 **Audio Error Messages** P. 315

If you operate the music app on your iPhone/iPod while the phone is connected to the audio system, you may no longer be able to operate the same app on the audio/information screen. Reconnect the device if necessary.

Select **USB device change** in the **Audio menu** screen to switch to another USB device.

■ How to Select a Play Mode

You can select repeat and shuffle modes when playing a file.

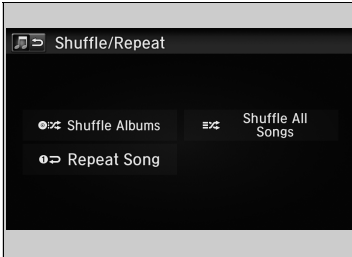

1. Press the  button.
2. Select **Shuffle/Repeat**.
3. Select a mode.

■ To turn off a play mode

1. Press the  button.
2. Select the mode you want to turn off.

▶▶ How to Select a Play Mode

Play Mode Menu Items

Shuffle Albums: Plays all available albums in a selected list (playlists, artists, albums, songs, podcasts, genres, composers, or audiobooks) in random order.

Shuffle All Songs: Plays all available files in a selected list (playlists, artists, albums, songs, podcasts, genres, composers, or audiobooks) in random order.

Repeat Song: Repeats the current track.

Playing a USB Flash Drive

Your audio system reads and plays sound and video files on a USB flash drive in either MP3, WMA, AAC*¹, or WAV format.

Connect your USB flash drive to the USB port, then select the USB mode.

➤ **USB Ports*** P. 242

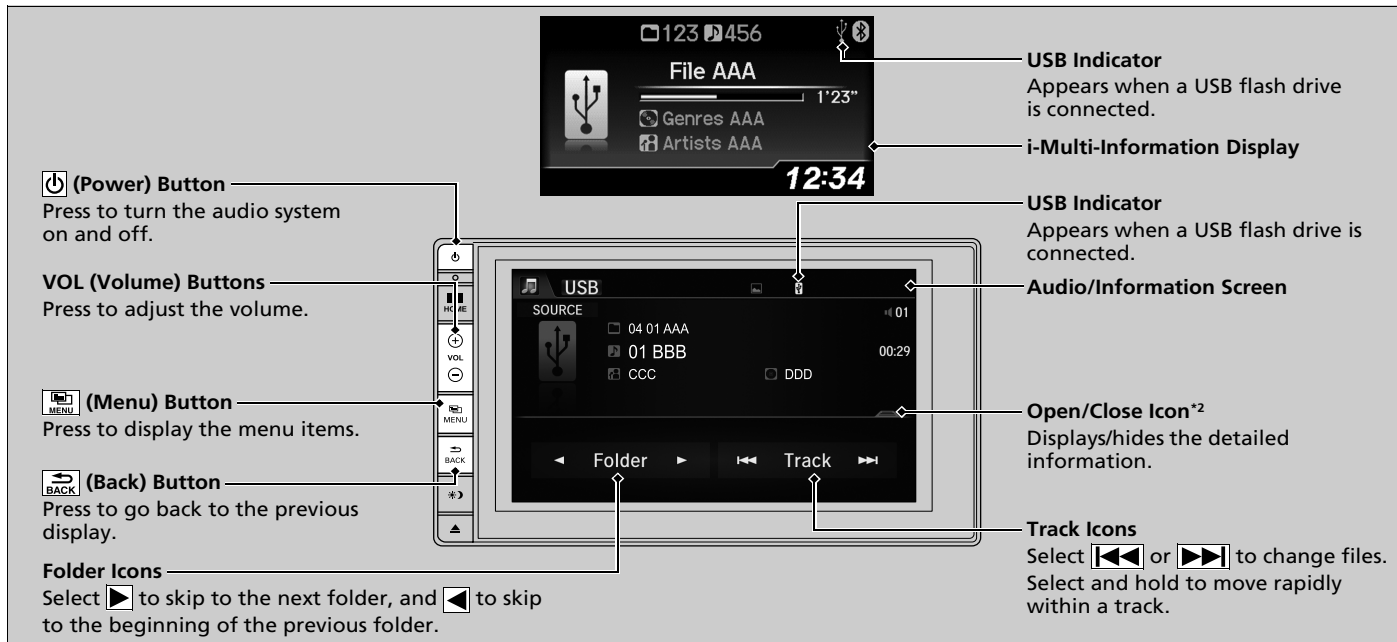

*1: Only AAC format files recorded with iTunes are playable on this unit.

*2: Some or all of the lists may not be displayed.

How to Select a File from the Music Search List

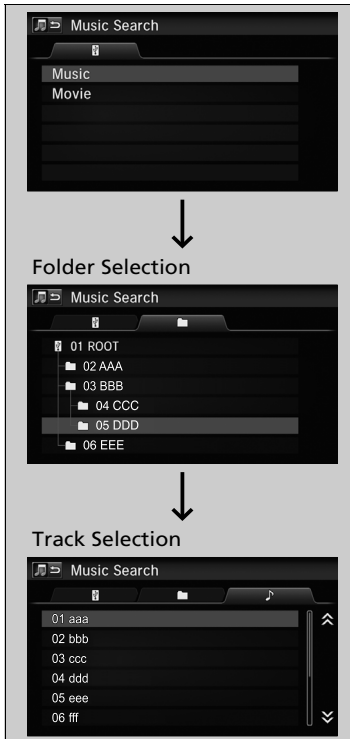

1. Press the  button and select **Music Search**.

2. Select **Music** or **Movie**.

3. Select a folder.

4. Select a track.

▶▶ Playing a USB Flash Drive

Use the recommended USB flash drives.

▶ **General Information on the Audio System**
P. 319

WMA files protected by digital rights management (DRM) cannot be played.

The audio system displays **Unplayable File**, then skips to the next file.

If there is a problem, you may see an error message on the audio/information screen.

▶ **Audio Error Messages** P. 315

Select **USB device change** in the **Audio menu** screen to switch to another USB device.

How to Select a Play Mode

You can select scan, repeat, and random modes when playing a file.

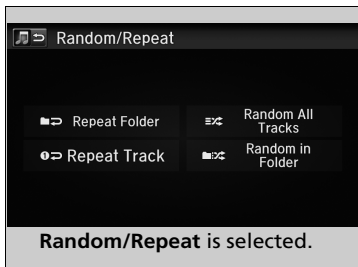

1. Press the  button.
2. Select **Scan** or **Random/Repeat**.
3. Select a mode.

To turn off a play mode

1. Press the  button.
2. Select the mode you want to turn off.

How to Select a Play Mode

Play Mode Menu Items

Scan

Scan Folder: Provides 10-second sampling of the first file in each of the main folders.

Scan Track (Scan Movies*¹): Provides 10-second sampling of all files in the current folder.

Random/Repeat

Repeat Folder: Repeats all files in the current folder.

Repeat Track (Repeat Movies*¹): Repeats the current file.

Random in Folder: Plays all files in the current folder in random order.

Random All Tracks (Random All Movies*¹): Plays all files in random order.

When playing a video file:

Play/Pause: Select to resume or play a file.

Stop: Select to stop a file.

*1: When playing a video file

Playing *Bluetooth*® Audio

Your audio system allows you to listen to music from your *Bluetooth*-compatible phone.

This function is available when the phone is paired and connected to the vehicle's Hands-Free Telephone (HFT) System.

📱 **Phone Setup** P. 370

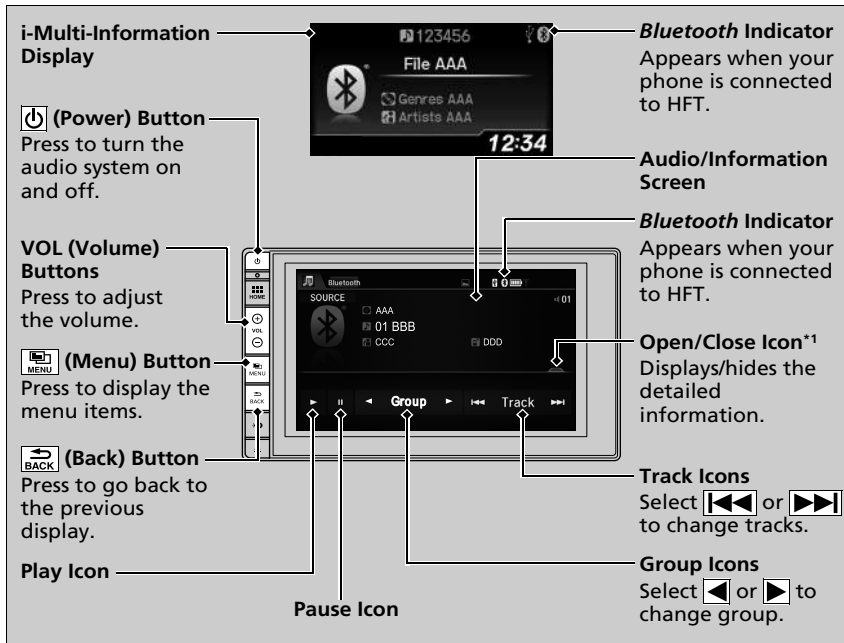

*1: Depending on the *Bluetooth*® device you connect, some or all of the lists may not be displayed.

▶▶ Playing *Bluetooth*® Audio

Not all *Bluetooth*-enabled phones with streaming audio capabilities are compatible. To check if your phone is compatible, ask a dealer.

It may be illegal to perform some data device functions while driving.

Only one phone can be used with HFT at a time. When there are more than two paired phones in the vehicle, the first paired phone the system finds is automatically connected.

If more than one phone is paired to the HFT system, there may be a delay before the system begins to play.

In some cases, the name of the artist, album, or track may not appear correctly.

Some functions may not be available on some devices.

Continued

■ To Play *Bluetooth*® Audio Files

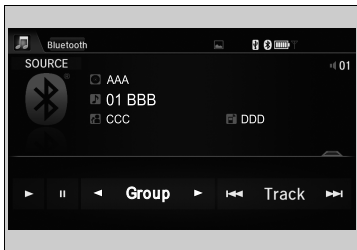



1. Make sure that your phone is paired and connected to the system.
 - ▶ **Phone Setup** P. 370
2. Select the *Bluetooth*® Audio mode.

If the phone is not recognised, another HFT-compatible phone, which is not compatible for *Bluetooth*® Audio, may already be connected.

- **To pause or resume a file**
Select the play icon or pause icon.

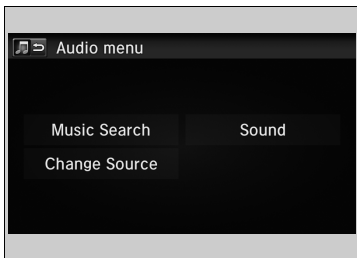
■ Searching for Music



1. Press the  button.
2. Select **Music Search**.
3. Select a search category (e.g., Albums).
4. Select an item.
 - ▶ The selection begins playing.

▶▶ To Play *Bluetooth*® Audio Files

To play the audio files, you may need to operate your phone. If so, follow the phone maker's operating instructions.

Switching to another mode pauses the music playing from your phone.

▶▶ Searching for Music

Depending on the *Bluetooth*® device you connect, some or all of the lists may not be displayed.

Playing a Video Using HDMI™

Your audio system allows you to play videos from an HDMI-compatible device. Connect the device, using an HDMI™ cable, then select the HDMI™ mode.

📄 **HDMI™ Port*** P. 243

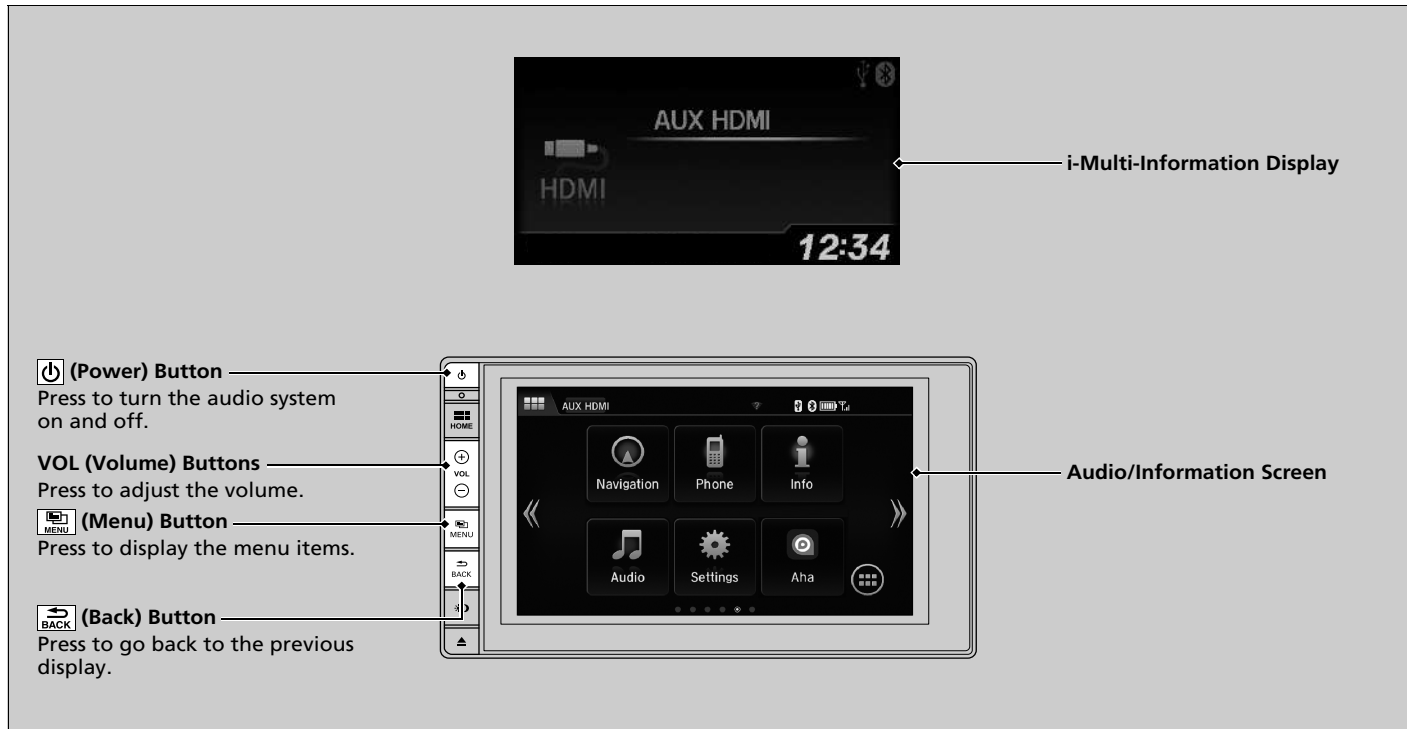

* Not available on all models

■ Changing the Screen Aspect

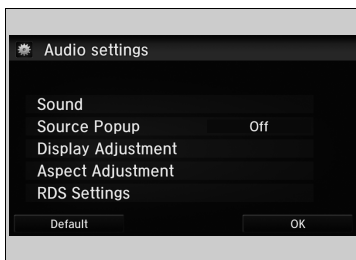

1. Press the  button.
2. Select **Settings**.
3. Select **Audio**.
4. Select **Aspect Adjustment**.
5. Select the setting you want.
6. Select **OK**.

▶▶ Playing a Video Using HDMI™

This feature is limited while driving. To play videos, stop your vehicle and apply the parking brake.

On Board Apps

Honda Connect has the capability of On Board Apps which may be created by Honda or by 3rd parties. Apps may be already installed or can be downloaded through Honda App Center. Some apps require internet access which can be established by Wi-Fi connection.

📶 **Wi-Fi Connection** P. 312

Please visit the below web address for further information:

<https://ivhs.os.ixonos.com/honda/help>

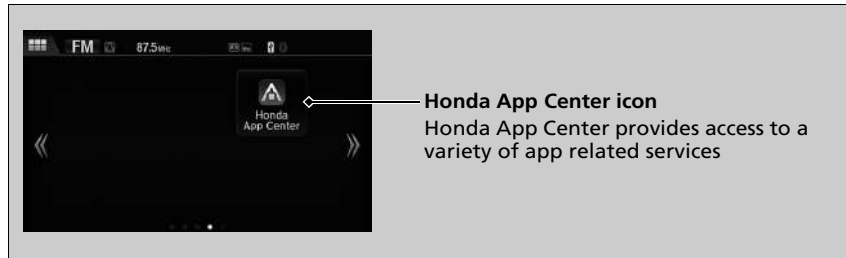

- Using the Display Audio system while driving can take your attention away from the road, causing a crash in which you could be seriously injured or killed. Only operate system controls when the conditions permit you to safely do so. **Please always adhere to the laws of the territory when operating this device.**
- Applications on the head unit are subject to change at anytime. This may mean that they are not available or operate differently. Honda shall not be liable to you in such instances.
- Applications available on the device may be provided by parties other than Honda to which 3rd party software licences and charges may apply.
- Data usage and roaming charges may result in using applications on the device in conjunction with your mobile phone and Honda is not liable for any costs you might incur from such use. Honda recommends you consult your mobile phone network provider in advance.
- Downloading applications from the Honda App Center will be subject to Terms and Conditions which can be found at: <https://ivhs.os.ixonos.com/honda/help>, and may also incur charges.

* Not available on all models

📶 On Board Apps

Make sure the GPS setting is turned on before using Honda App Center.

📶 **Customized Features*** P. 323

Even if you change **Background Colour** on the **System settings** screen, it will not be reflected on the Honda App Center screen.

Smartphone Connection

Some of your smartphone apps can be displayed and operated on the audio/information screen when the phone is connected to the audio system. You can connect your phone using a cable, or wirelessly.

➤ **Connecting Your iPhone** P. 311

➤ **Wi-Fi mode (setting for the first time)** P. 312

To use smartphone connection, you need to first pair your smartphone to the audio system via *Bluetooth*®.

➤ **Phone Setup** P. 370

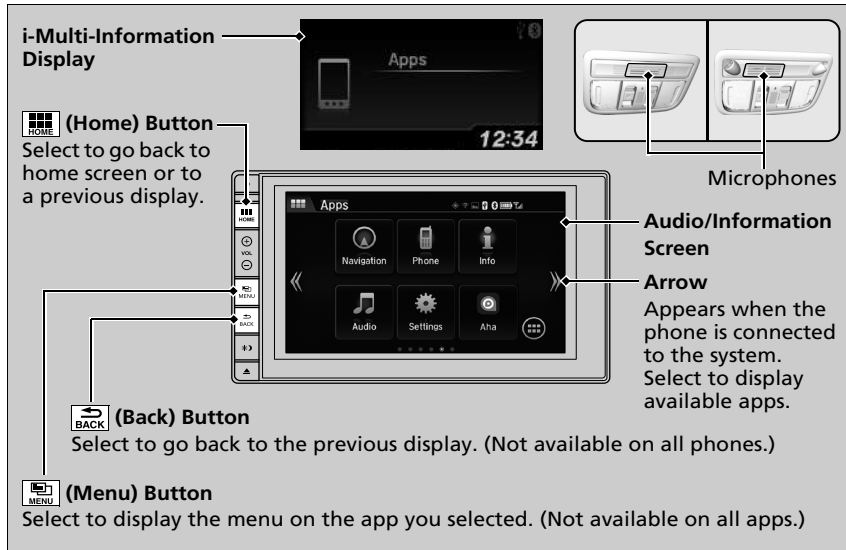

Smartphone Connection

Park in a safe place before connecting your phone and while operating the displayed apps.

Not all phones are compatible with the system. The system does not display all the available apps on your smartphone, and some apps need to be preinstalled. Ask a dealer for details.

You need to switch the *Bluetooth*® connection to your smartphone if another electronic device is connected.

➤ **To change the currently paired phone** P. 371

The following may vary by phone type:

- How to connect a smartphone to the system.
- Apps that can be operated on the screen.
- Display response time/update time

We do not support every app operation on the audio system.

Ask the app provider for any queries on the app's features.

Do not get drawn into the display while operating a vehicle.

■ Connecting Your iPhone

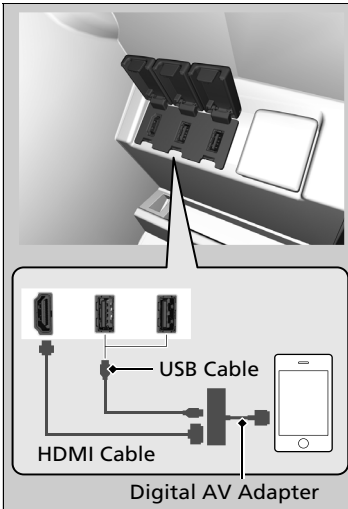

1. Connect your phone to the audio system via *Bluetooth*®.
▶ **Phone Setup** P. 370
2. Plug in the digital AV adapter to the HDMI™ port.
3. Connect the digital AV adapter to your iPhone.
▶ Wait until an arrow appears on the home screen.
4. Select the arrow to display the available smartphone apps on the audio/information screen.
▶ You may need to operate from the phone.
5. Select an app you want to operate from the audio/information screen.
▶ To go back to the previous screen, press the  button.

☒ Connecting Your iPhone

Make sure to plug in the digital AV adapter to the HDMI™ port first. If not, smartphone connection may not work properly.

To recharge your phone, connect it to the USB port, too.

Contact a dealer for the digital AV adapter or HDMI™ cable purchasing information.

Wi-Fi Connection

You can connect the display audio system to the Internet using Wi-Fi and browse websites or use online services on the audio/information screen. If your phone has mobile hotspot capabilities, the system can be tethered to the phone. Go through the following steps for a setup.

Wi-Fi mode (setting for the first time)

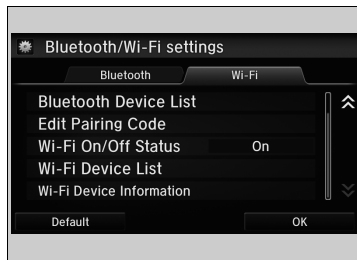

1. Press the button.
2. Select **Settings**.
3. Select **Bluetooth / Wi-Fi**.
4. Select the **Wi-Fi** tab.
5. Select **Wi-Fi On/Off Status**, then **On**.
6. Select **Wi-Fi Device List**.
 - ▶ Make sure your phone's Wi-Fi setting is in access point (tethering) mode.
 - ▶ Select the phone you want to connect to the system.
 - ▶ If you do not find the phone you want to connect in the list, select **Scan**.
7. Select **Connect**.
 - ▶ Enter a password for your phone, and select **OK**.
 - ▶ When the connection is successful, the icon is displayed on the list.
8. Press the button to go back to the home screen.

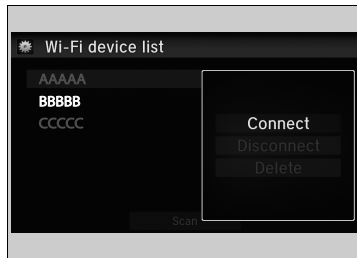

Wi-Fi mode (setting for the first time)

You cannot go through the setting procedure while a vehicle is moving. Park in a safe place to set the audio system in Wi-Fi mode.

Some telecom carriers charge for tethering. Check your phone's subscribed package.

Check your phone manual to find out if the phone has Wi-Fi connectivity.

You can confirm whether Wi-Fi connection is on or off with the icon on **Wi-Fi Device list**. Transmission speed and others will not be displayed on this screen.

If you cannot enter the password on the displayed keyboard, change the keyboard to the one in which you can enter from the following order:
Settings → **Android** → **Language & input** → select next to **Android keyboard** → **Input language** → uncheck the box next to **Use system language** → select the keyboard languages that you can enter.

■ Wi-Fi mode (after the initial setting has been made)

Make sure your phone's Wi-Fi setting is in access point (tethering) mode.

☒ Wi-Fi mode (after the initial setting has been made)

iPhone users

You may need to go through an initial setup for Wi-Fi connection again after you boot your phone.

Siri Eyes Free

You can talk to Siri using the  (Talk) button on the steering wheel when your iPhone is paired to the Hands-Free Telephone (HFT) System.

▶ **Phone Setup** P. 370

■ Using Siri Eyes Free

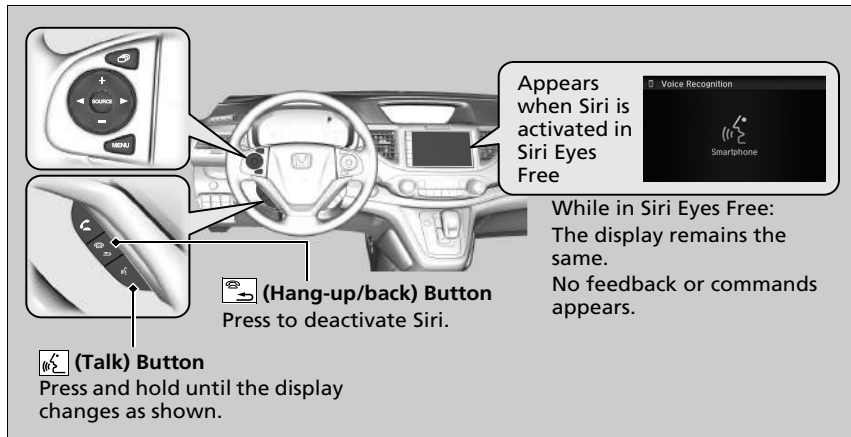

▶ Siri Eyes Free

Siri is a trademark of Apple Inc.

Check Apple Inc. website for features available for Siri.







We recommend against using Siri other than in Siri Eyes Free while operating a vehicle.

▶ Using Siri Eyes Free

Some commands work only on specific phone features or apps.

CD Player*

If a disc error occurs, you may see the following error messages.

Error Message	Cause	Solution
Heat error	High temperature	<ul style="list-style-type: none"> Turn the audio system off and allow the player to cool down until the error message is cleared.
Unsupported* ¹	Track/file format not supported	<ul style="list-style-type: none"> Current track/file will be skipped. The next supported track/file plays automatically.
Unplayable File* ²		
Bad disc Please check owners manual. Push eject* ¹	Mechanical error	<ul style="list-style-type: none"> Press the  (eject)*¹/ (eject/CLOSE)*² button and remove the disc, and check that the error message is cleared. Check that the disc is not damaged or deformed, and insert the disc again. <ul style="list-style-type: none">  Protecting CDs P. 319 If the error message reappears, press the  (eject)*¹/ (eject/CLOSE)*² button, and pull out the disc. Insert a different disc. If the error message repeats, or the disc cannot be removed, contact a dealer. <p>Do not try to force the disc out of the player.</p>
Bad Disc Please Check Owner's Manual Push Eject* ²		
Mechanical error		
Bad disc Please check owners manual.* ¹	Servo error	<ul style="list-style-type: none"> If the new disc plays, there is a problem with the first disc. If the error message repeats, or the disc cannot be removed, contact a dealer. <p>Do not try to force the disc out of the player.</p>
Bad Disc Please Check Owner's Manual* ²		
Check disc	Disc error	<ul style="list-style-type: none"> Check that the disc is not damaged or deformed. <ul style="list-style-type: none">  Protecting CDs P. 319

*1:Audio system with one display

*2:Audio system with two displays

* Not available on all models

iPod/USB Flash Drive

If an error occurs while playing an iPod or USB flash drive, you may see the following error messages. If you cannot clear the error message, contact a dealer.

Error Message	Solution
USB error	Appears when there is a problem with the USB adapter unit. Check if the device is compatible with the USB adapter unit.
Incompatible USB device^{*1}	
Incompatible USB Device Please Check Owner's Manual^{*2}	Appears when an incompatible device is connected. Disconnect the device. Then turn the audio system off, and turn it on again. Do not reconnect the device that caused the error.
No Song^{*1}	Appears when the iPod is empty. Check that compatible files are stored on the device.
Unsupported ver^{*1}	
Unsupported Version^{*2}	Appears when an unsupported iPod is connected. If it appears when a supported iPod is connected, update the iPod software to the newer version.
Retry connection^{*1}	
Connect Retry^{*2}	Appears when the system does not acknowledge the iPod. Reconnect the iPod.
Unplayable file	Appears when the files in the USB flash drive are DRM or an unsupported format. This error message appears for about three seconds, then plays the next song.

*1:Audio system with one display

*2:Audio system with two displays





Error Message	Solution
No data	iPod^{*1} Appears when the iPod is empty. Check that compatible files are stored on the device. USB flash drive Appears when the USB flash drive is empty or there are no MP3, WMA, or AAC files in the USB flash drive. Check that compatible files are stored on the device.
Unsupported	Appears when an unsupported device is connected. If it appears when a supported device is connected, reconnect the device.

*1:Audio system with two displays

Models with two displays

Android/Apps

If an error occurs while using the audio system or apps, you may see the following error messages. If you cannot clear the error message, contact a dealer.

Error Message	Solution
Unfortunately, **** has stopped.	<p>Error has occurred within app, select OK on the screen to close the app. Unless it is a fatal error, it would return to normal if you startup the app. If it does not return to normal even after starting up the app, press and hold the  (Power) button to perform the forced reset. If it still does not get back to normal, you need Factory Data Reset.</p> <p> Factory Data Reset P. 339</p>
**** is not responding. Would you like to close it?	<p>App is in a busy state. Select Wait if you can wait for a response from app a little longer. If it does not respond even if you keep waiting, select OK to close the app and start it up. When it does not return to normal, press and hold the  (Power) button to perform the forced reset. You also need Factory Data Reset.</p> <p> Factory Data Reset P. 339</p>
Security warning	<p>Occurs if you open the browser when the system date is older than the certificate date information. It also occurs when you are in the area where GPS reception is unavailable or GPS setting of the Android setting is turned off.</p> <ul style="list-style-type: none"> - Turn on GPS setting of the Android setting. - Move to the area where GPS reception is available. <p> Customized Features* P. 323</p>

**** part is variable characters, and will change depending upon where an error occurs.

General Information on the Audio System

Recommended CDs*

- Use only high-quality CD-R or CD-RW discs labelled for audio use.
- Use only CD-R or CD-RW discs on which the recordings are closed.
- Play only standard round shaped CDs.

The CD packages or jackets should have one of these marks.



CDs with MP3, WMA, or AAC* files

- Some software files may not allow for audio play or text data display.
- Some versions of MP3, WMA, or AAC* formats may be unsupported.

Protecting CDs

Follow these precautions when handling or storing CDs:

- Store a CD in its case when it is not being played.
- When wiping a CD, use a soft clean cloth from the centre to the outside edge.
- Handle a CD by its edge. Never touch either surface.
- Never insert foreign objects into the CD player.
- Keep CDs out of direct sunlight and extreme heat.
- Do not place stabilizer rings or labels on the CD.
- Avoid fingerprints, liquids, and felt-tip pens on the CD.

Recommended CDs*

A Dual-disc cannot play on this audio unit. If recorded under certain conditions, a CD-R or CD-RW may not play either.

Protecting CDs

NOTICE

Do not insert a damaged CD. It may get stuck inside and damage the audio unit.

Examples:

- Bubbled, wrinkled, labelled, and excessively thick CDs



Bubbled/
Wrinkled



With Label/
Sticker



Using Printer
Label Kit

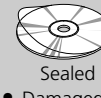

Sealed



With Plastic Ring

- Damaged CDs

- Poor quality CDs



Chipped/
Cracked



Warped

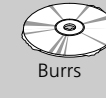

Burrs

- Small CDs

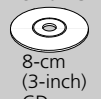

8-cm
(3-inch)
CD

* Not available on all models

Compatible iPod, iPhone, and USB Flash Drive

■ iPod and iPhone Model Compatibility

Model
iPod (5th generation)
iPod classic
iPod nano (1st to 6th generation) launch in 2010
iPod nano (7th generation) launch in 2012
iPod touch (1st to 4th generation) launch in 2010
iPod touch (5th generation) launch in 2012
iPhone 3G/iPhone 3GS/iPhone 4/iPhone 4s/iPhone 5/iPhone 5c ^{*1} /iPhone 5s ^{*1}

* 1: Models with two displays

■ USB Flash Drives

- Use a recommended USB flash drive of 256 MB or higher.
- Some digital audio players may not be compatible.
- Some USB flash drives (e.g., a device with security lockout) may not work.
- Some software files may not allow for audio play or text data display.
- Some versions of MP3, WMA, AAC, or WAV^{*} formats may be unsupported.

⌘ iPod and iPhone Model Compatibility

This system may not work with all software versions of these devices.

⌘ USB Flash Drives

Files on the USB flash drive are played in their stored order. This order may be different from the order displayed on your PC or device.

Models with two displays

Recommended Devices

Media	USB Flash Drive	
Profile (MP4 version)	Baseline Level 3 (MPEG4-AVC), Simple Level 5 (MPEG4)	
File extension (MP4 version)	.mp4/.m4v	
Compatible audio codec	AAC	MP3
Compatible video codec	MPEG4-AVC (H.264)	MPEG4 (ISO/IEC 14496 Part.2)
Bit rate	10 Mbps (MPEG4-AVC)	8 Mbps (MPEG4)
Maximum image	720 × 576 pixels	



About Open Source Licences

To see the open source licence information, follow these steps.

1. Select .
2. Select **Settings**.
3. Select **Android**.
4. Select **About device**.
5. Select **Legal information**.
6. Select **Open source licences**.

▶ About Open Source Licences

You can also go to step 4 when you:

- Swipe down from the top.
 - ▶ Select  appears on the screen.
- Select , then select **Settings** on the **App** tab.

Audio system with two displays

Use the audio/information screen to customize certain features.

■ How to customize

With the ignition switch in ON **[II]***1, select **Settings**, then select a setting item.

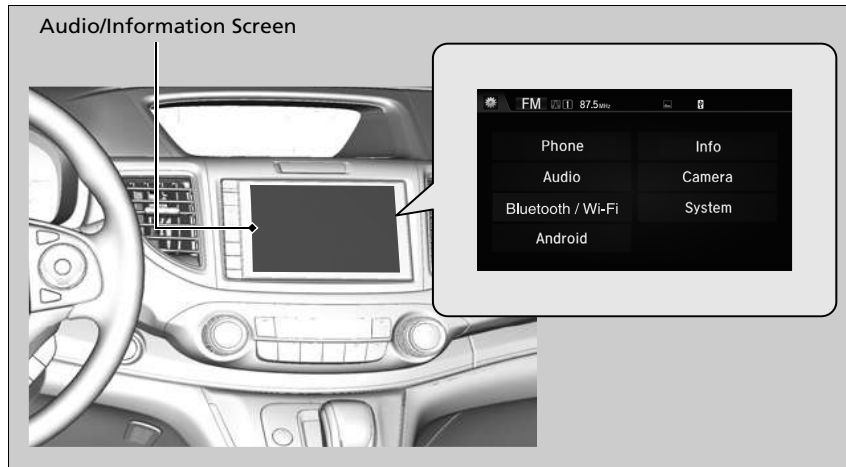

*1: Models with the keyless access system have an **ENGINE START/STOP** button instead of an ignition switch.

* Not available on all models

Continued

▶ Customized Features*

When you customize settings, make sure that the vehicle is at a complete stop and shift to **[P]**.

To customize other features, select **Settings**.

▶ **List of customizable options** P. 328

If you press and hold the **[P]** (power) button when resetting the system, it may restore the customized value to its default value depending on the setting items.

■ Customization flow

Press the  button.

Select **Settings**.

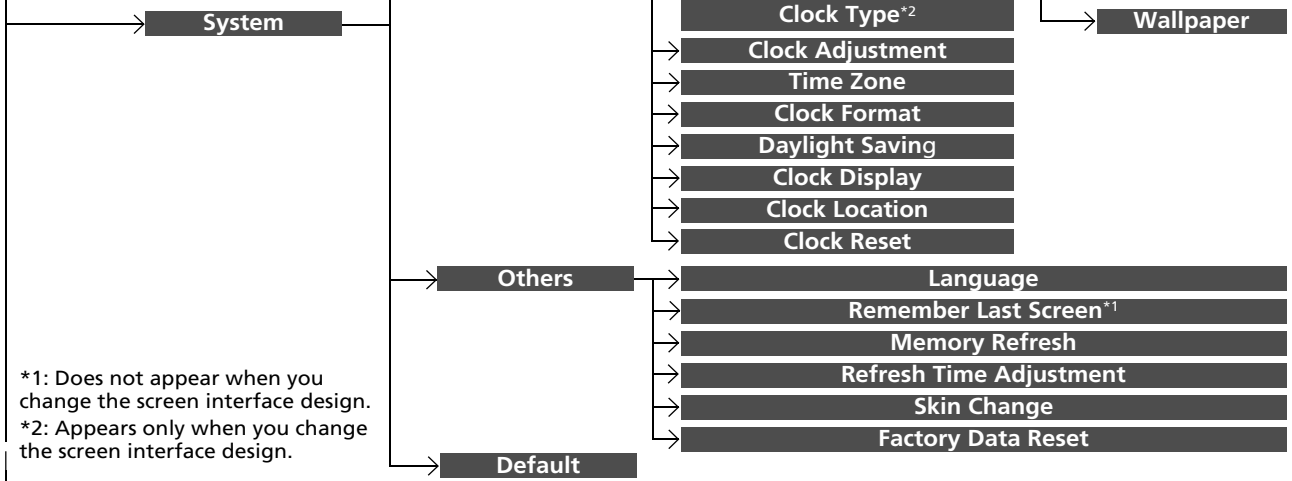
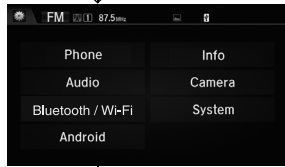

*1: Does not appear when you change the screen interface design.
 *2: Appears only when you change the screen interface design.

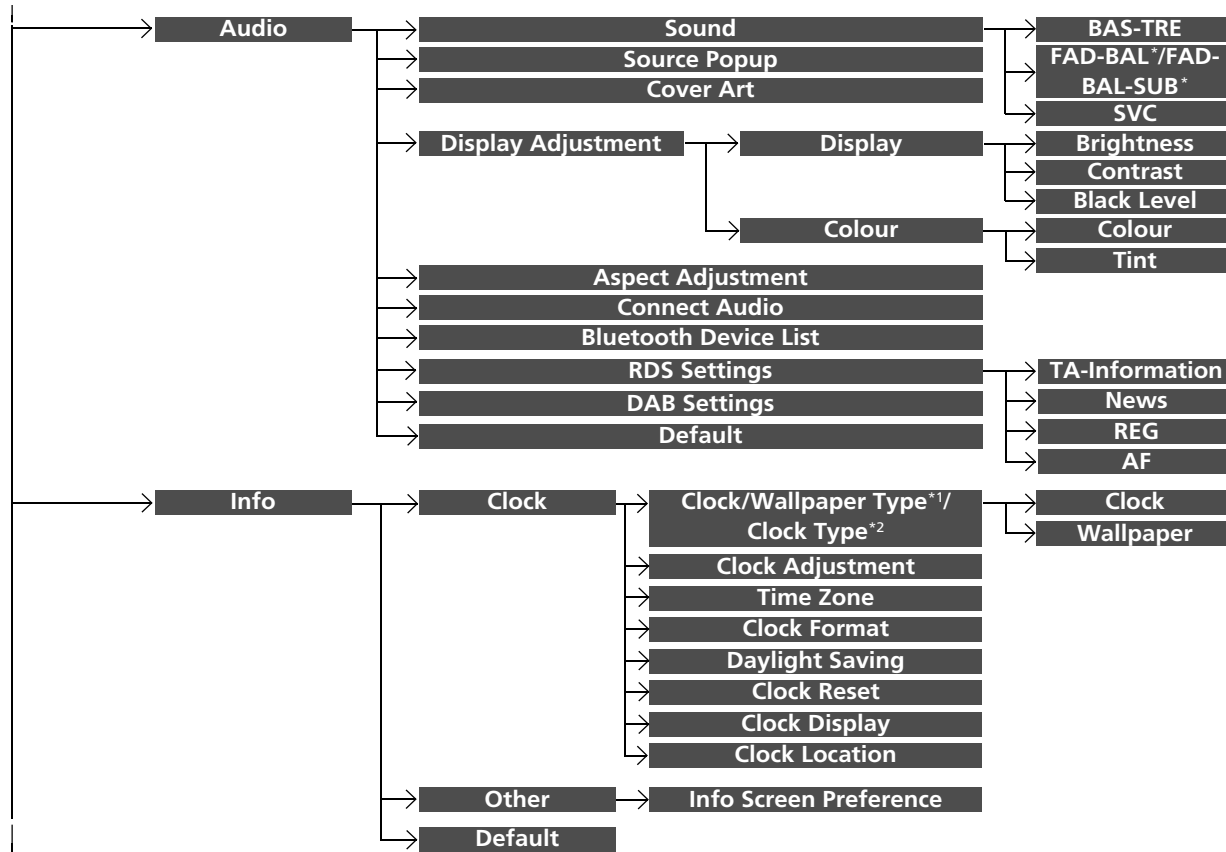

* Not available on all models

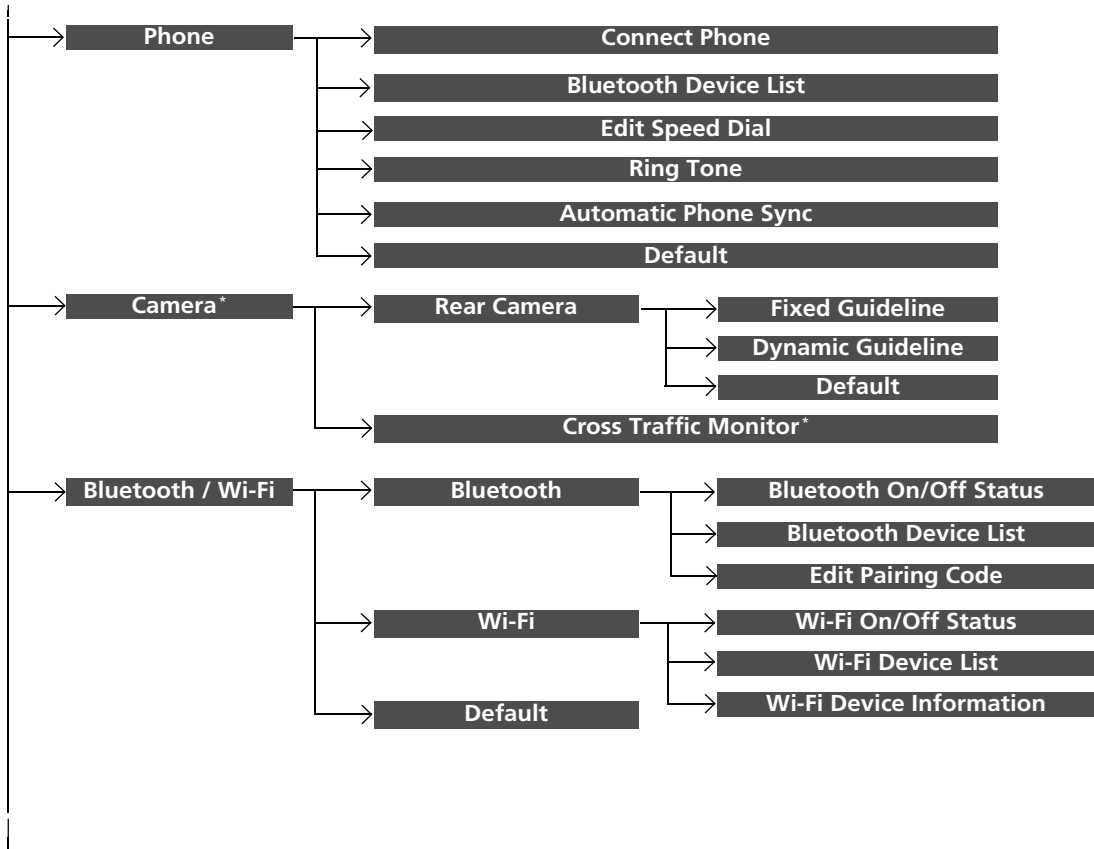

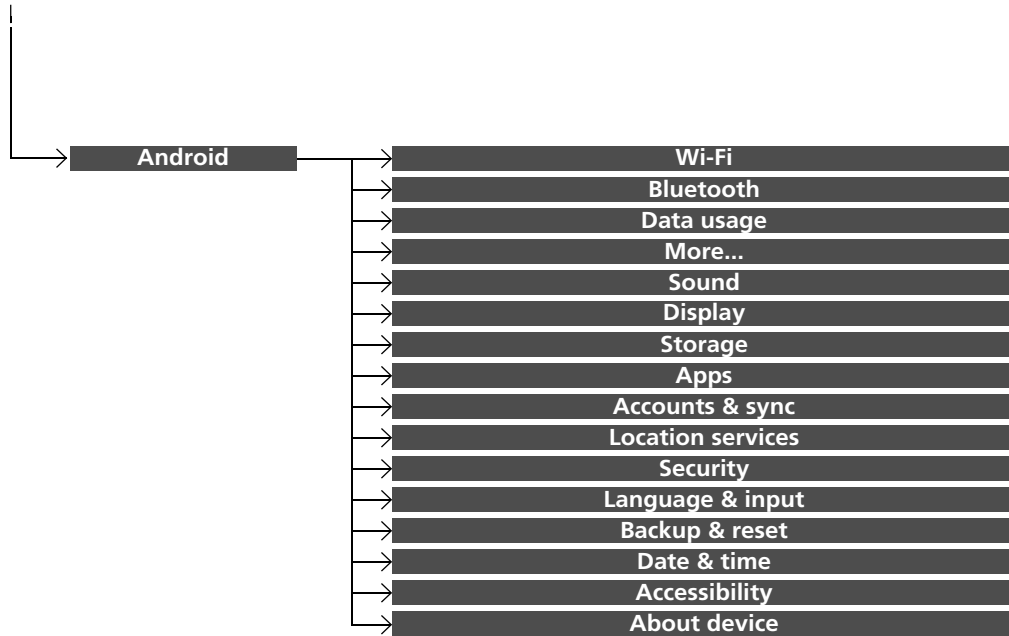

■ List of customizable options

Setup Group	Customizable Features	Description	Selectable Settings		
System	HOME	Home icon position	Changes the home screen icon layout.	—	
		Menu Icon Position* ³	Changes the home screen icon layout.	—	
	Display	Brightness	Brightness	Changes the brightness of the audio/information screen.	—
			Contrast	Changes the contrast of the audio/information screen.	—
		Black Level	Black Level	Changes the black level of the audio/information screen.	—
			Background Colour* ²	Changes the background colour of the audio/information screen.	Blue* ¹ /Amber/Red/Violet
	Sound/Beep	Volume	Changes the sound volume. Adjusts the guidance volume of the navigation system. ☞ Refer to the Navigation System Manual	0 ~ 6* ¹ ~ 11	
			Beep	Changes the beep volume.	Off/1/2* ¹ /3
	Voice Recog.	Voice Prompt	Turns the voice prompt on and off.	On* ¹ /Off	

*1:Default Setting

*2:Does not appear when you change the screen interface design.

*3:Appears only when you change the screen interface design.

Setup Group	Customizable Features	Description	Selectable Settings	
System	Clock/ Wallpaper Type ^{*2/} Clock Type ^{*3}	Clock	Changes the clock display type.	Analog/Digital^{*1/} Small Digital/Off
		Wallpaper	<ul style="list-style-type: none"> • Changes the wallpaper type. • Imports an image file for a new wallpaper. • Deletes an image file for a wallpaper. 	Galaxy^{*1/}Metallic/ Blank
		Clock Adjustment	Adjusts clock. ☑ Clock P. 156	—
		Time Zone	Changes the time zones.	GMT/WET^{*1}
		Clock Format	Selects the digital clock display from 12H to 24H.	12H^{*1/}24H
		Daylight Saving	Adjusts the clock automatically when a summer time change occurs.	On^{*1/}Off
		Clock Display	Selects whether the clock display comes on.	On/Off^{*1}
		Clock Location	Changes the clock display layout.	Upper right^{*1/}Upper left/Lower right/ Lower left/Off
		Clock Reset	Resets the clock settings to the factory default.	—

*1:Default Setting

*2:Does not appear when you change the screen interface design.

*3:Appears only when you change the screen interface design.

Setup Group	Customizable Features	Description	Selectable Settings
System	Language	Changes the display language.	English (United Kingdom)*1 : See other selectable languages on the screen.
	Remember Last Screen ⁺²	Selects whether the device remembers the last screen.	On/Off ⁺¹
	Others		
	Memory Refresh	Turns on the audio system automatically and restores the fragmentation of a memory when the ignition switch is LOCK <input type="checkbox"/> *3.	On ⁺¹ / Off
	Refresh Time Adjustment	Sets the time for Memory Fresh .	00:00 ~ 02:00 ⁺¹ ~ 23:59
	Skin Change	Changes the screen interface design.	—
	Factory Data Reset	Resets all the settings to their factory default. <input checked="" type="checkbox"/> Defaulting All the Settings P. 339	Yes/No
Default	Cancels/Resets all customized items in the System settings group as default.	Yes/No	
Audio	Sound	Adjusts the settings of the audio speakers' sound. <input checked="" type="checkbox"/> Adjusting the Sound P. 248	-6 ~ 0 ⁺¹ ~ +6 (Bass, Treble and SUBW*) , RR9 ~ 0 ⁺¹ ~ FR9 (FADER) , L9 ~ 0 ⁺¹ ~ R9 (BALANCE) , Off/Low/Mid ⁺¹ / High (Speed Volume Compensation)

*1:Default Setting

*2:Does not appear when you change the screen interface design.

*3:Models with the keyless access system have an **ENGINE START/STOP** button instead of an ignition switch.

Setup Group	Customizable Features	Description	Selectable Settings		
Audio	Source Popup	Selects whether the list of selectable audio sources comes on when Audio is selected on the home screen.	On/Off ^{*1}		
	CD, iPod, USB mode Cover Art	Turns the cover art display on and off.	On ^{*1} / Off		
	Display Adjustment	Display	Brightness	See System on P. 328	
			Contrast		
		Colour	Black Level		—
			Colour		
	USB, HDMI™ mode	Aspect Adjustment	Selects the display mode with a different aspect ratio from Original (only USB)*, Normal , Full and Zoom .	Original (only USB)*/ Normal/Full ^{*1} / Zoom	
	Bluetooth® Audio mode	Connect Audio	Connects, disconnects or pairs a <i>Bluetooth®</i> Audio device to HFT.	—	
	Bluetooth® Audio mode	Bluetooth Device List	Pairs a new phone to HFT, edits or deletes a paired phone. ☞ Phone Setup P. 370	—	

*1: Default Setting

* Not available on all models

Setup Group	Customizable Features	Description	Selectable Settings	
Audio	TA-Information	Turns on and off the traffic announcement function.	On/Off ^{*1}	
	RDS Settings	News	Turns on and off the alternative frequency function.	On/Off ^{*1}
		REG	Turns on and off the regional function.	On ^{*1} / Off
		AF	Turns on and off the interruption news function.	On ^{*1} / Off
		DAB-DAB Link	Selects whether the system automatically searches for the same station from Ensembles, and switches to it.	On ^{*1} / Off
	DAB Settings	DAB-FM Link	Selects whether the system finds the same station from an FM band, and automatically switches the band.	On ^{*1} / Off
		Band select	Selects specific bands to reduce the time to update the lists, and search for a station.	BOTH ^{*1} / BAND III/L-BAND
Default		Cancels/Resets all customized items in the Audio settings group as default.	Yes/No	



*1:Default Setting

Setup Group	Customizable Features	Description	Selectable Settings																
Info	<table border="1"> <tr> <td>Clock/ Wallpaper Type^{*2}/Clock Type^{*3}</td> <td>Clock Wallpaper</td> </tr> <tr> <td>Clock Adjustment</td> <td></td> </tr> <tr> <td>Time Zone</td> <td></td> </tr> <tr> <td>Clock Format</td> <td></td> </tr> <tr> <td>Daylight Saving</td> <td></td> </tr> <tr> <td>Clock Reset</td> <td></td> </tr> <tr> <td>Clock Display</td> <td></td> </tr> <tr> <td>Clock Location</td> <td></td> </tr> </table>	Clock/ Wallpaper Type^{*2}/Clock Type^{*3}	Clock Wallpaper	Clock Adjustment		Time Zone		Clock Format		Daylight Saving		Clock Reset		Clock Display		Clock Location		See System on P. 329	
	Clock/ Wallpaper Type^{*2}/Clock Type^{*3}	Clock Wallpaper																	
	Clock Adjustment																		
	Time Zone																		
	Clock Format																		
	Daylight Saving																		
	Clock Reset																		
	Clock Display																		
	Clock Location																		
	Other	Info Screen Preference	Changes the information screen type.	Info Top/Info Menu/ Off^{*1}															
Default		Cancels/Resets all customized items in the Info settings group as default.	Yes/No																

*1: Default Setting

*2: Does not appear when you change the screen interface design.

*3: Appears only when you change the screen interface design.

Setup Group	Customizable Features	Description	Selectable Settings
Phone	Connect Phone	Pairs a new phone to HFT, connects or disconnects a paired phone.  Phone Setup P. 370	—
	Bluetooth Device List	Pairs a new phone to HFT, edits or deletes a paired phone.  Phone Setup P. 370	—
	Edit Speed Dial	Edits, adds or deletes a speed dial entry.  Speed Dial P. 376	—
	Ring Tone	Selects the ring tone.	Fixed/Mobile phone *1
	Automatic Phone Sync	Sets phonebook and call history data to be automatically imported when a phone is paired to HFT.	On/Off
	Default	Cancels/Resets all customized items in the Phone settings group as default.	Yes/No

*1: Default Setting

Setup Group	Customizable Features	Description	Selectable Settings
Camera*	Rear Camera		
	Fixed Guideline	Selects whether the fixed guidelines come on the rear camera monitor. <input checked="" type="checkbox"/> Multi-View Rear Camera * P. 519	On^{*1}/Off
	Dynamic Guideline	Selects whether the dynamic guidelines come on the rear camera monitor. <input checked="" type="checkbox"/> Multi-View Rear Camera * P. 519	On^{*1}/Off
	Default	Cancels/Resets all customized items in the Rear Camera group as default.	Yes/No
	Cross Traffic Monitor*	Turns on and off the cross traffic monitor.	On/Off

*1:Default Setting

Setup Group	Customizable Features	Description	Selectable Settings
Bluetooth / Wi-Fi	Bluetooth On/Off Status	Selects to display the <i>Bluetooth</i> ® status.	On*¹/Off
	Bluetooth Device List	Pairs a new phone to HFT, edits or deletes a paired phone, or creates a security PIN. ➤ Phone Setup P. 370	—
	Edit Pairing Code	Edits a pairing code. ➤ To change the pairing code setting P. 371	Random/Fixed*¹
	Wi-Fi On/Off Status	Changes the Wi-Fi mode.	On*¹/Off
	Wi-Fi Device List	Connects, disconnects, or deletes the Wi-Fi device.	—
	Wi-Fi Device Information	Shows the Wi-Fi information of the device.	—
Default		Cancels/Resets all customized items in the Bluetooth / Wi-Fi settings group as default.	Yes/No

*1:Default Setting

Setup Group	Customizable Features	Description	Selectable Settings
Android	Wi-Fi	Shows the status of the Wi-Fi connection (On/Off) and adds new Wi-Fi networks.	On^{*1}/Off
	Bluetooth	Shows the status of the <i>Bluetooth</i> ® connection (On/Off) and adds the connections with new Bluetooth devices.	On^{*1}/Off
	Data usage	Shows the data usage of the system.	—
	More...	Adds VPN (Virtual Private Network).	—
	Sound	Adjusts the alarm volume and selects the favorite sound.	—
	Display	Sets up the wallpaper and changes the font size.	—
	Storage	Shows the storage capacity of the system and the USB capacity.	—
	Apps	Shows the status of the installed apps.	—
	Accounts & sync	Adds the additional account information.	—

*1:Default Setting

Setup Group	Customizable Features	Description	Selectable Settings
Android	Location services	Turn on/off the GPS Setting before using apps.	—
	Security	Shows the security status of the system.	—
	Language & input	Changes the display language of the system and the input keyboard.	—
	Backup & reset	Resets the system.	—
	Date & time	Changes the date, the time zones, and the clock format.	—
	Accessibility	Changes the display font of the system and the voice guidance of the password.	—
	About device	Shows the status of the system, the Android version, the legal information, and so on.	—

Defaulting All the Settings

Reset all the menu and customized settings as the factory defaults.

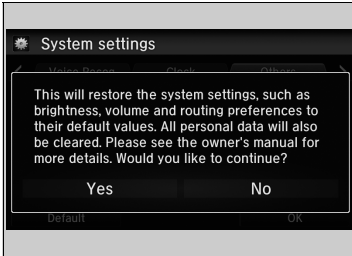

1. Press the  button.
2. Select **Settings**.
3. Select **System**.
4. Select the **Others** tab.
5. Select **Factory Data Reset**.
 - ▶ A confirmation message appears on the screen.
6. Select **Yes** to reset the settings.
7. Select **Yes** again to reset the settings.
 - ▶ A confirmation message appears on the screen. Select **OK**.

Defaulting All the Settings

When you transfer the vehicle to a third party, reset all settings to default and delete all personal data.

If you perform **Factory Data Reset**, it will reset the preinstalled apps to their factory default.

Hands-Free Telephone System*

Audio system with one display

Hands-Free Telephone (HFT) System allows you to place and receive phone calls using your vehicle's audio system, without handling your mobile phone.

Using HFT

HFT Buttons

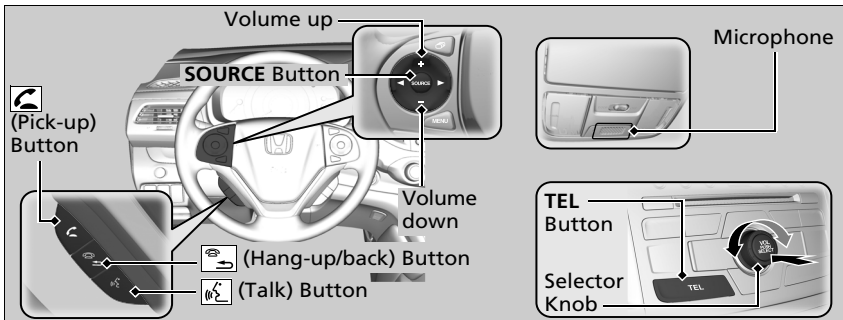



(Pick-up) button: Press to go directly to the **Phone** screen or to answer an incoming call.

(Hang-up/back) Button: Press to end a call, go back to the previous command, or cancel a command.

(Talk) Button: Press to give a command or answer a call.

TEL Button: Press to go directly to the **Phone** screen.

Selector knob: Rotate  to select an item on the screen, then press .

Hands-Free Telephone System*

To use the system, you need a *Bluetooth*-compatible mobile phone. For a list of compatible phones, pairing procedures, and special feature capabilities:

- Europe: Visit <http://www.hondahandsfree.com/>.

Voice control tips

- Aim the vents away from the ceiling and close the windows, as noise coming from them may interfere with the microphone.
- Press the  (Talk) button when you want to call a number using a stored voice tag. Speak clearly and naturally after a beep.
- If the microphone picks up voices other than yours, the command may be misinterpreted.
- To change the volume level, use the audio system's volume knob or the remote audio controls on the steering wheel.

If you receive a call while using the audio system, the system resumes its operation after ending the call.

HFT Status Display

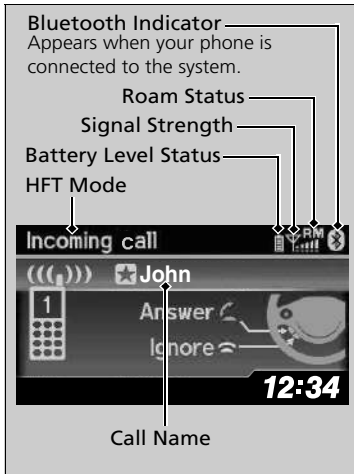

The i-multi-information display notifies you when there is an incoming call.

Limitations for Manual Operation

Certain manual functions are disabled or inoperable while the vehicle is in motion. You cannot select a grayed-out option until the vehicle is stopped.

Only previously stored speed dial entries with voice tags, phonebook names, or numbers can be called using voice commands while the vehicle is in motion.

➤ **Speed Dial** P. 355

Hands-Free Telephone System*

Bluetooth® Wireless Technology

The *Bluetooth*® word mark and logos are registered trademarks owned by *Bluetooth SIG, Inc.*, and any use of such marks by Honda Motor Co., Ltd., is under licence. Other trademarks and trade names are those of their respective owners.

HFT Limitations

An incoming call on HFT will interrupt the audio system when it is playing. It will resume when the call is ended.

European models

For information of DoC (Declaration of Conformance) Hereby, Johnson Controls Automotive, declares that this Hands-Free Telephone System is in compliance with the essential requirements and other relevant provisions of Directive 1999/5/EC.

www.jciblueconnect.com/faq/EU_Doc.pdf

Except European models

For additional conformance information:

www.jciblueconnect.com/faq

HFT Status Display

The information that appears on the i-multi-information display varies between phone models.

You can change the system language from English to other available one.

➤ **Customized Features** P. 145

* Not available on all models

HFT Menu

The ignition switch must be in ACCESSORY **I** or ON **II** to use HFT.

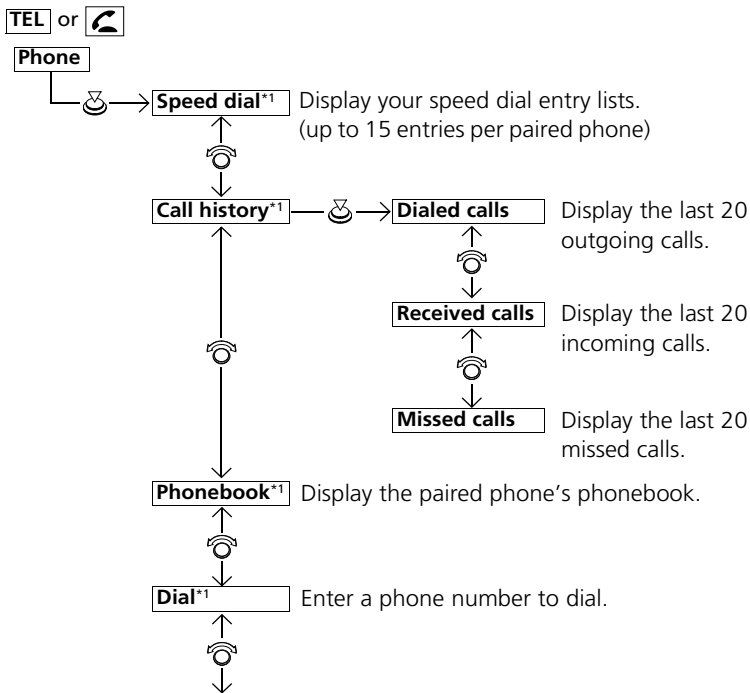

HFT Menus

To use the system, you must first pair your *Bluetooth*-compatible mobile phone to the system while the vehicle is parked.

*1:Appears only when a phone is connected to the system.

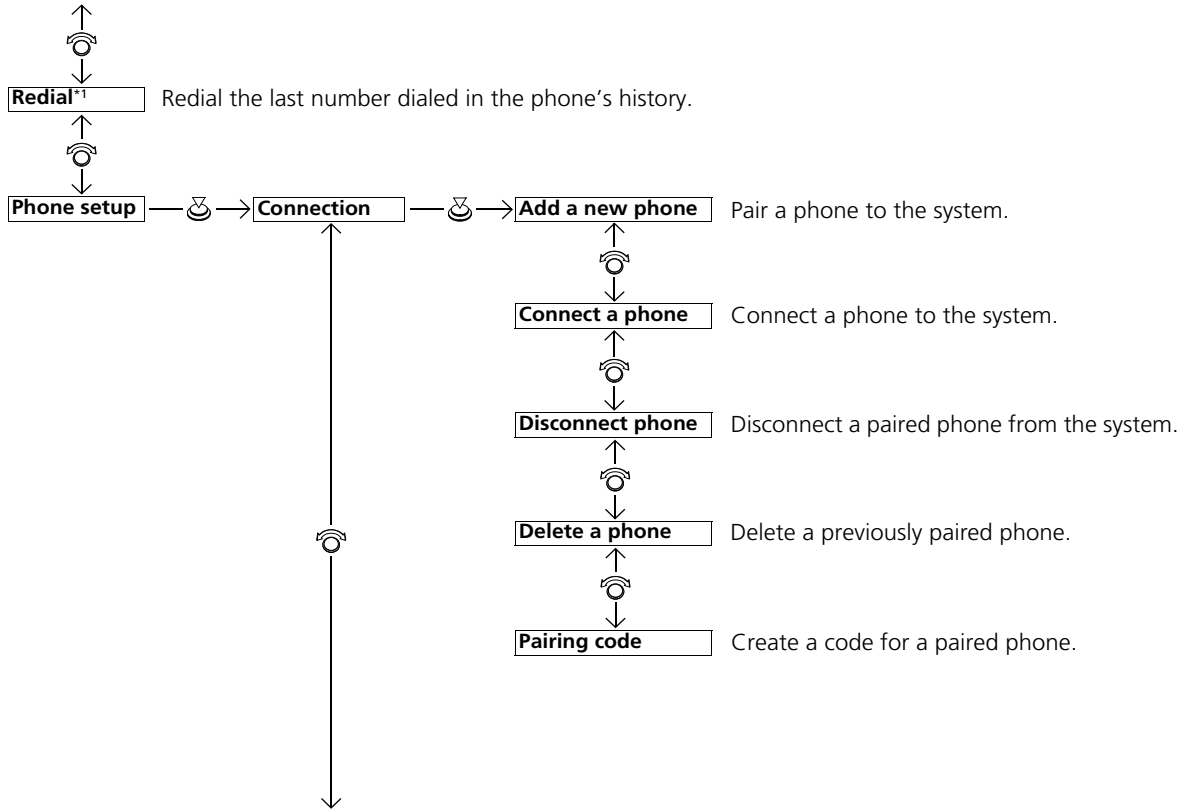

*1:Appears only when a phone is connected to the system.

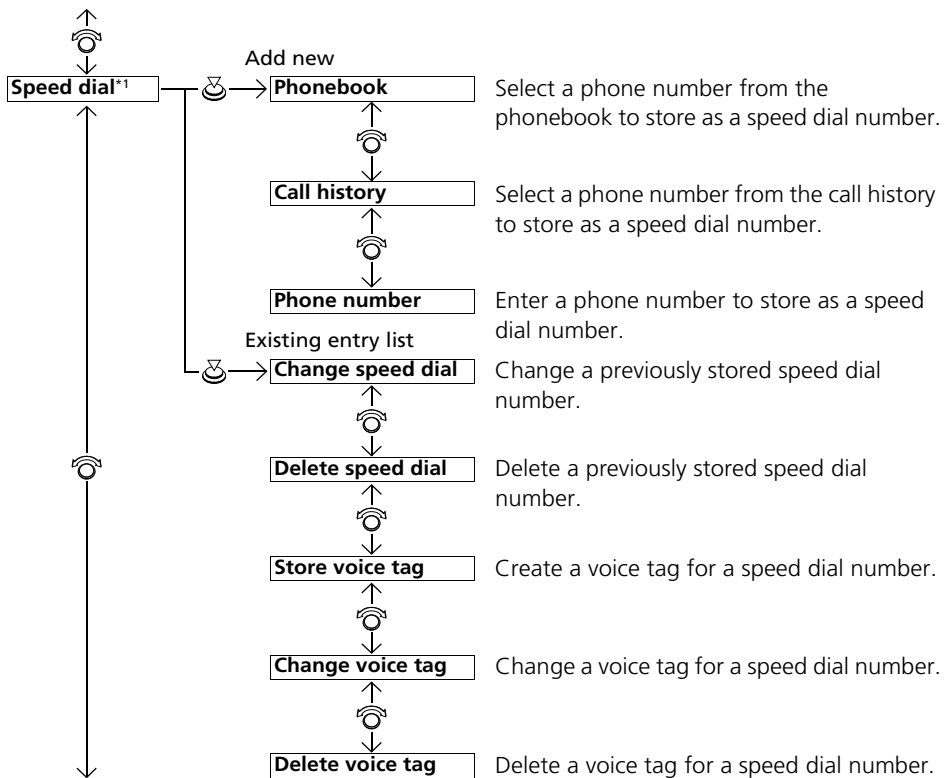

*1:Appears only when a phone is connected to the system.

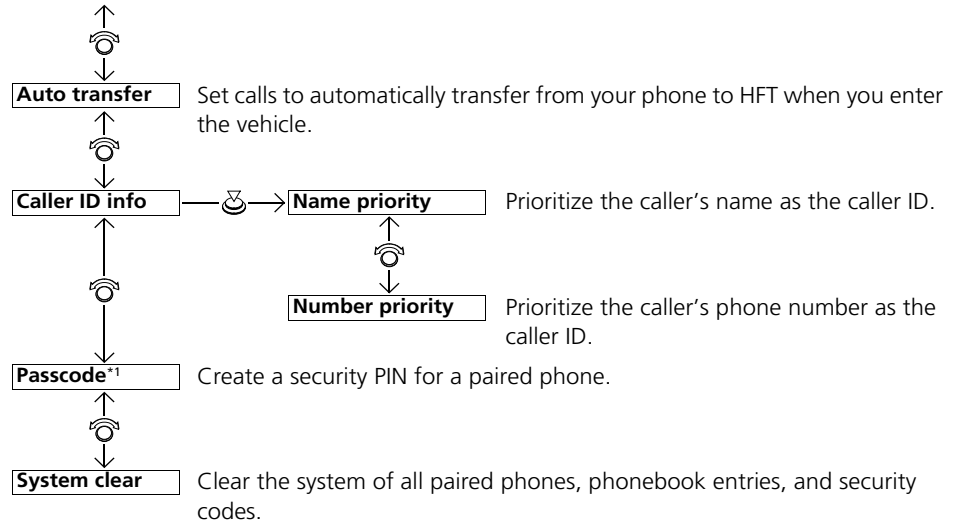

*1:Appears only when a phone is connected to the system.

Phone Setup

■ To pair a mobile phone (No phone has been paired to the system)

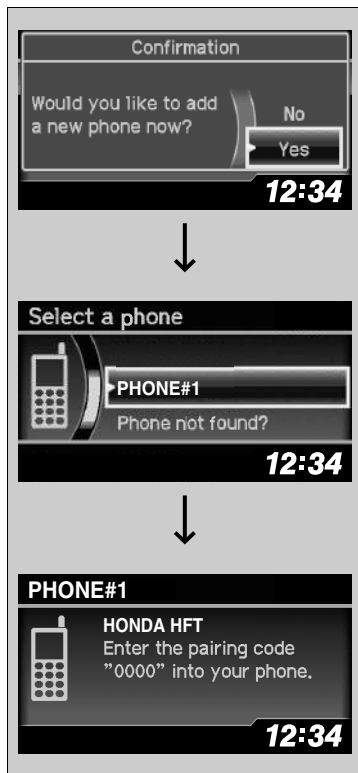

1. Press the **TEL** button or the button.
2. Rotate to select **Yes**, then press .
3. Make sure your phone is in search or discoverable mode, then press .
 - ▶ The system automatically searches for a Bluetooth device.

4. When your phone appears on the list, select it by pressing .
 - ▶ If your phone doesn't appear, select **Phone not found?** and search for Bluetooth devices using your phone. From your phone, select **HONDA HFT**.

5. The system gives you a four-digit pairing code to input on your phone. When your phone prompts you, input the four-digit pairing code.
6. A notification appears on the screen if pairing is successful.

Phone Setup

Your *Bluetooth*-compatible phone must be paired to the system before you can make and receive hands-free calls.

Phone Pairing Tips:

- You cannot pair your phone while the vehicle is moving.
- Up to six phones can be connected.
- Your phone's battery may drain faster when it is paired to the system.
- If your phone is not ready for pairing or not found by the system within three minutes, the system will time out and returns to idle.







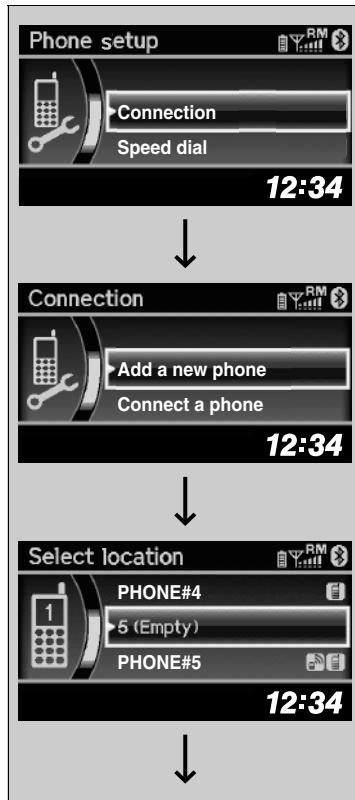

Once you have paired a phone, you can see it displayed on the screen with one or two icons on the right side.

These icons indicate the following:

- : The phone can be used with HFT.
- : The phone is compatible with *Bluetooth*® Audio.

■ To pair a mobile phone (when a phone has already been paired to the system)



1. Press the **TEL** button or the  button.
2. Rotate  to select **Phone setup**, then press .
 - ▶ If a prompt appears asking to connect to a phone, select **No** and proceed with step 2.
3. Rotate  to select **Connection**, then press .
4. Rotate  to select **Add a new phone**, then press .
 - ▶ The screen changes to **Select location**.
5. Rotate  to select **Empty**, then press .

Continued

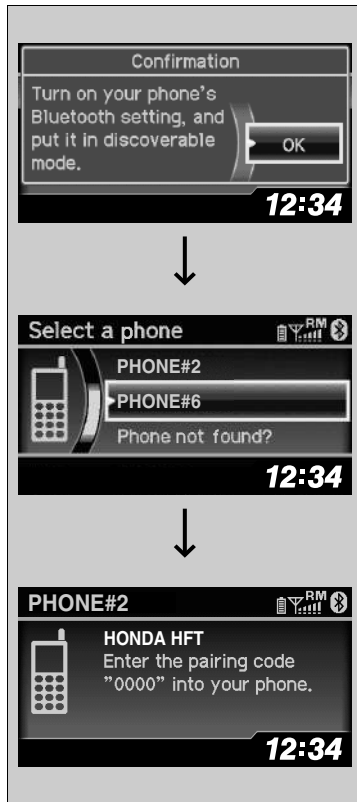









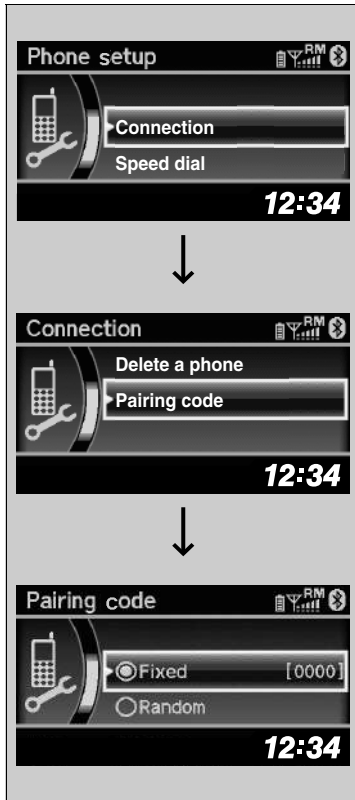

6. Make sure your phone is in search or discoverable mode, then press .
 - ▶ The system automatically searches for a Bluetooth device.

7. When your phone appears on the list, select it by pressing .
 - ▶ If your phone doesn't appear, select **Phone not found?** and search for Bluetooth devices using your phone. From your phone, select **HONDA HFT**.

8. The system gives you a four-digit pairing code to input on your phone. When your phone prompts you, input the four-digit pairing code.
9. A notification appears on the screen if pairing is successful.

■ To change the pairing code setting



1. Press the **TEL** button or the  button.
 - ▶ Rotate  to select **Phone setup**, then press .
2. Rotate  to select **Connection**, then press .
3. Rotate  to select **Pairing code**, then press .
4. Rotate  to select **Fixed** or **Random**, then press .

▣ To change the pairing code setting

The default pairing code is **0000** until you change the setting.





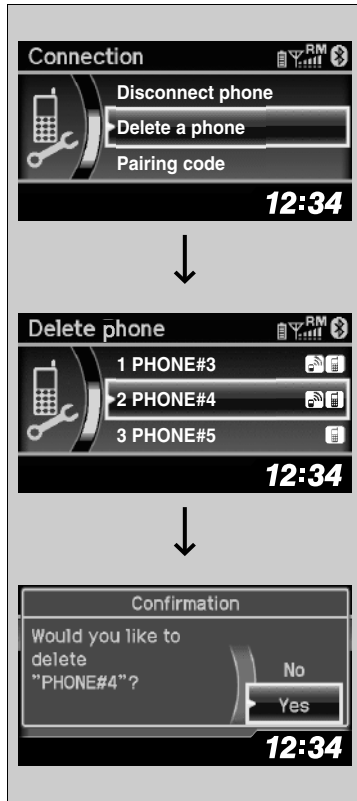

To create your own, select **Fixed**, and delete the current code, then enter a new one.

For a randomly generated pairing code each time you pair a phone, select **Random**.

Continued

■ To delete a paired phone



1. Press the **TEL** button or the  button.
2. Rotate  to select **Phone setup**, then press .
▶ Repeat the procedure to select **Connection**, then **Delete a phone**.
3. Rotate  to select a phone you want to delete, then press .
4. A confirmation message appears on the screen. Rotate  to select **Yes**, then press .
▶ A notification appears if the deletion is successful.

To Create a Security PIN

You can protect each of the six mobile phones with a security PIN.

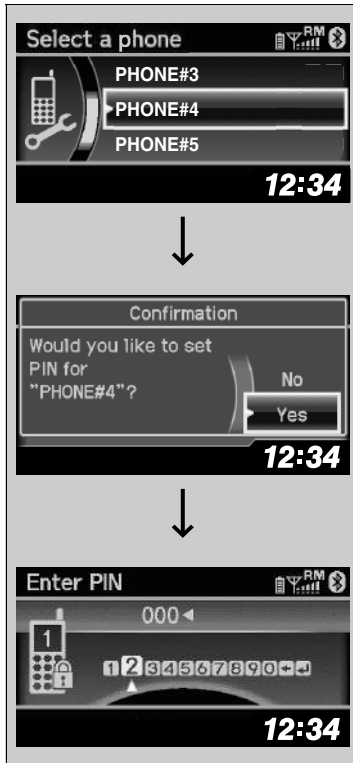

1. Press the **TEL** button or the button.
2. Rotate to select **Phone setup**, then press .
 - ▶ Repeat the procedure to select **Passcode**.
3. Select a phone you want to add a security PIN to.
 - ▶ Rotate to select a phone you want to add a security PIN to, then press .
4. A confirmation message appears on the screen.
 - ▶ Rotate to select **Yes**, then press .
5. Enter a new four-digit number.
 - ▶ Rotate to select, then press . Press to delete. Press to enter the security PIN.
6. Re-enter the four-digit number.
 - ▶ The screen returns to the screen in step 2.

Continued

▶ To Create a Security PIN

If the phone is already security PIN protected, you need to enter the current security PIN before clearing the PIN or creating a new one.

Automatic Transferring

If you get into the vehicle while you are on the phone, the call can be automatically transferred to the system.



1. Press the **TEL** button or the button.
2. Rotate to select **Phone setup**, then press .
 - ▶ Repeat the procedure to select **Auto transfer**.
3. Rotate to select **On**, then press .
4. A notification appears on the screen if the change is successful.

Caller's ID Information

You can select a caller's information to be displayed when you have an incoming call.

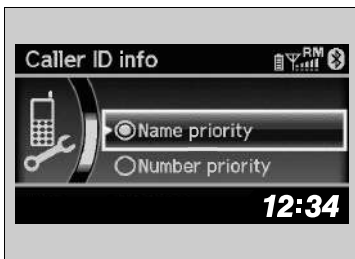

1. Press the **TEL** button or the button.
2. Rotate to select **Phone setup**, then press .
 - ▶ Repeat the procedure to select **Caller ID info**.
3. Rotate to select a mode you want, then press .
4. A notification appears on the screen if the change is successful.

☒ Caller's ID Information

Name priority mode: A caller's name is displayed if it is stored in the phonebook.

Number priority mode: A caller's phone number is displayed.

■ To Clear the System

Security codes, paired phones, all stored voice tag, all speed dial entries, and all imported phonebook data are erased.

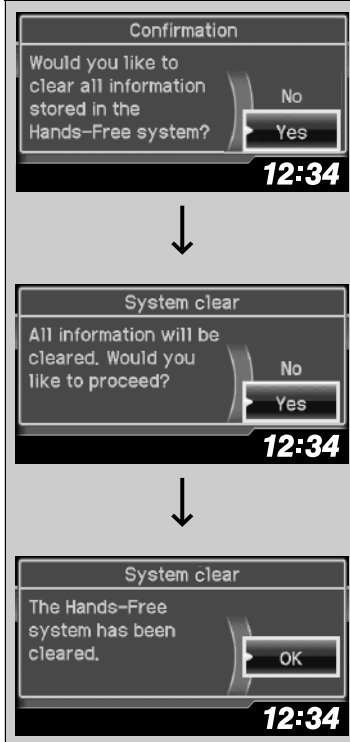

1. Press the **TEL** button or the button.
2. Rotate to select **Phone setup**, then press .
 - ▶ Repeat the procedure to select **System clear**.
3. Rotate to select **Yes**, then press .
4. A confirmation message appears on the screen. Rotate to select **Yes**, then press .
5. A confirmation message appears on the screen. Press to finish.

Continued

Automatic Import of Mobile Phonebook and Call History

When your phone is paired, the contents of its phonebook and call history are automatically imported to the system.



Automatic Import of Mobile Phonebook and Call History

When you select a person from the list in the mobile phonebook, you can see up to three category icons. The icons indicate what types of numbers are stored for that name.



If a name has four or more numbers, ... appears instead of category icons.

On some phones, it may not be possible to import the category icons to the system.

The phonebook is updated after every connection. Call history is updated after every connection or call.

Speed Dial

Up to 15 speed dial numbers can be stored per phone.

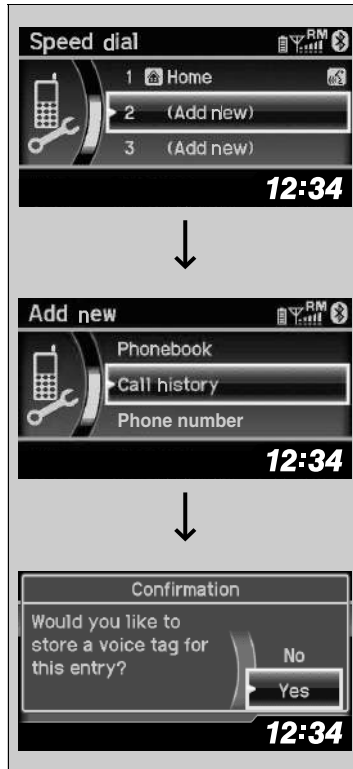

To store a speed dial number:

1. Press the **TEL** button or the button.
2. Rotate to select **Phone setup**, then press .
 - ▶ Repeat the procedure to select **Speed dial**, then **Add new**.
3. Rotate to select a place to choose a number from, then press .
 - By **Phonebook**:
 - ▶ Select a number from the connected mobile phone's imported phonebook.
 - By **Call history**:
 - ▶ Select a number from the call history.
 - By **Phone number**:
 - ▶ Input the number manually.
4. When the speed dial is successfully stored, you are asked to create a voice tag for the number. Rotate to select **Yes** or **No**, then press .
5. Using the button, follow the prompts to say the name for the speed dial entry.

Speed Dial

You can use the audio preset buttons during a call to store a speed dial number:

1. Press and hold the desired audio preset button during a call.
2. The contact information for the active call will be stored for the corresponding speed dial.

Continued

■ To add a voice tag to a stored speed dial number









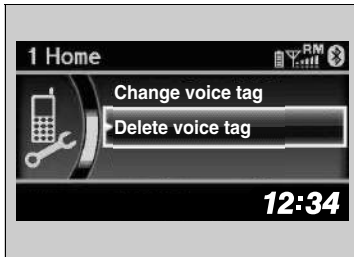

1. Press the **TEL** button or the button.
2. Rotate to select **Phone setup**, then press .
- ▶ Repeat the procedure to select **Speed dial**.
3. Select an existing speed dial entry.
4. Rotate to select **Store voice tag**, then press .
5. Using the button, follow the prompts to complete the voice tag.

▣ Speed Dial

Avoid using duplicate voice tag.
Avoid using "home" as a voice tag.
It is easier for the system to recognize a longer name.
For example, use "John Smith" instead of "John."







■ To delete a voice tag



1. Press the **TEL** button or the  button.
2. Rotate  to select **Phone setup**, then press .
 - ▶ Repeat the procedure to select **Speed dial**.
3. Select an existing speed dial entry.
4. Rotate  to select **Delete voice tag**, then press .
 - ▶ A confirmation message appears on the screen. Rotate  to select **Yes**, then press .

■ To delete a speed dial number



1. Press the **TEL** button or the  button.
2. Rotate  to select **Phone setup**, then press .
 - ▶ Repeat the procedure to select **Speed dial**.
3. Select an existing speed dial entry.
4. Rotate  to select **Delete speed dial**, then press .
 - ▶ A confirmation message appears on the screen. Rotate  to select **Yes**, then press .

■ Making a Call

You can make calls by inputting any phone number, or by using the imported phonebook, call history, speed dial entries, or redial.

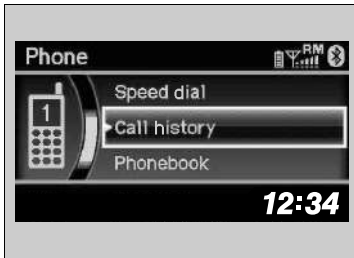

▣ Making a Call

The maximum range between your phone and vehicles is 10 metres (30 feet).

Once a call is connected, you can hear the voice of the person you are calling through the audio speakers.

Any voice-tagged speed dial entry can be dialed by voice from any screen.

Press the  button and follow the prompts.

■ To make a call using the imported phonebook



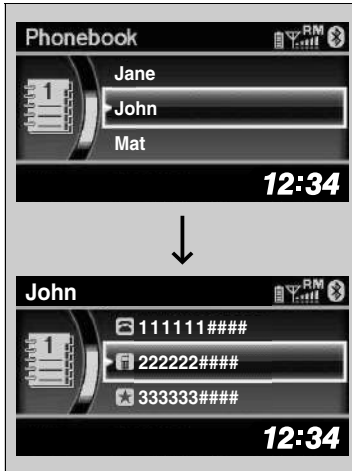





When your phone is paired, the contents of its phonebook are automatically imported to the system.



1. Press the **TEL** button or the button.
 2. Rotate to select **Phonebook**, then press .
 3. The phonebook is stored alphabetically. Rotate to select the initial, then press .
 4. Rotate to select a name, then press .
 5. Rotate to select a number, then press .
- ▶ Dialing starts automatically.



■ To make a call using a phone number

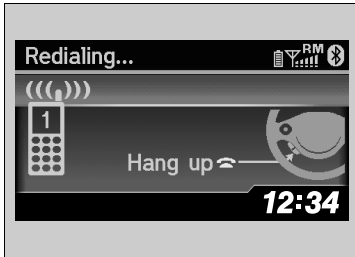

1. Press the **TEL** button or the  button.
2. Rotate  to select **Dial**, then press .
3. Rotate  to select a number, then press .
4. Rotate  to select , then press .
▶ Dialing starts automatically.

■ To make a call using redial









1. Press the **TEL** button or the  button.
2. Rotate  to select **Redial**, then press .
▶ Dialing starts automatically.

■ To make a call using the call history





Call history is stored by **Dialed calls**, **Received calls**, and **Missed calls**.

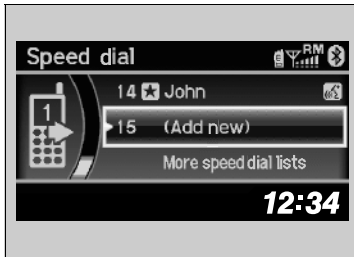

1. Press the **TEL** button or the  button.
2. Rotate  to select **Call history**, then press .
3. Rotate  to select **Dialed calls**, **Received calls**, or **Missed calls**, then press .
4. Rotate  to select a number, then press .
 - ▶ Dialing starts automatically.

■ To make a call using a speed dial entry



1. Press the **TEL** button or the  button.
2. Rotate  to select **Speed dial**, then press .
3. Rotate  to select a number, then press .
 - ▶ Dialing starts automatically.

☒ To make a call using the call history

The call history appears only when a phone is connected to the system, and displays the last 20 dialed, received, or missed calls.

☒ To make a call using a speed dial entry

On the **Phone** screen, the first six speed dials on the list can be directly selected by pressing the corresponding audio preset buttons (1-6).



Select **More speed dial lists** to view another paired phone's speed dial list.

Any voice-tagged speed dial entry can be dialed by voice from any screen. Press the  button and follow the prompts.

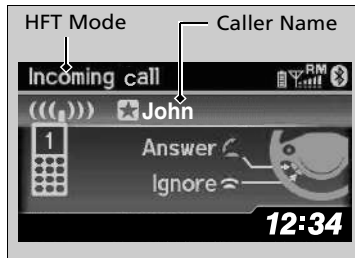
Receiving a Call





When there is an incoming call, an audible notification sounds (if activated) and the **Incoming call** screen appears.

Press the  button to answer the call.
Press the  button to decline or end the call.

Receiving a Call

Call Waiting

Press the  button to put the current call on hold to answer the incoming call.

Press the  button again to return to the current call.

Ignore the incoming call if you do not want to answer it.

Press the  button if you want to hang up the current call.

Options During a Call

The following options are available during a call.



Mute: Mute your voice.

Transfer call: Transfer a call from HFT to your phone.

Touch tones: Send numbers during a call. This is useful when you call an automated phone system.



1. To view the available options, press the **TEL** button.

2. Rotate  to select the option, then press .

- ▶ The check box is checked when **Mute** is selected. Select **Mute** again to turn it off.

Options During a Call

Touch tones: Available on some phones.

Hands-Free Telephone System

Audio system with two displays

The Hands-Free Telephone (HFT) System allows you to place and receive phone calls using your vehicle's audio system, without handling your mobile phone.

Using HFT

HFT Buttons

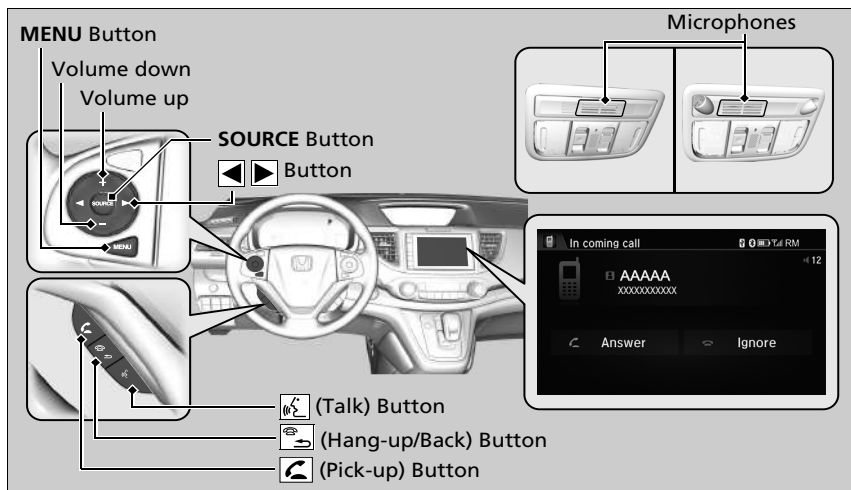

Hands-Free Telephone System

To use HFT, you need a *Bluetooth*-compatible mobile phone. For a list of compatible phones, pairing procedures, and special feature capabilities, ask a dealer or your local Honda.

To use the system, the **Bluetooth On/Off Status** setting must be **On**.

➤ **Customized Features*** P. 323

Voice control tips

- Aim the vents away from the ceiling and close the windows, as noise coming from them may interfere with the microphones.
- Press the  button when you want to call a number using a stored voice tag. Speak clearly and naturally after a beep.
- If the microphones pick up voices other than yours, the command may be misinterpreted.
- To change the volume level, select the audio system's **VOL** (Volume) or use the remote audio controls on the steering wheel.

Up to five speed dial entries can be displayed among a total of 20 that can be entered. If there is no entry in the system, Speed Dial is disabled.

➤ **Speed Dial** P. 376

Up to five call histories can be displayed among a total of 20 that can be entered. If there is no call history, Call History is disabled.

 **(Pick-up) button:** Press to go directly to the phone screen, or to answer an incoming call.

 **(Hang-up/back) button:** Press to end a call, go back to the previous command, or cancel a command.



 **(Talk) button:** Press to call a number with a stored voice tag.

MENU button: Press and hold to display **Speed Dial**, **Call History**, or **Redial** on the phone screen.

  **button:** Press to select an item displayed on the phone screen.

SOURCE button: Press to call a number listed in the selected item on the phone screen.

To go to the **Phone Menu** screen:

1. Press the  button.
2. Select **Phone** to switch the display to the phone screen.
3. Press the  button.

Hands-Free Telephone System

Bluetooth® Wireless Technology

The *Bluetooth*® word mark and logos are registered trademarks owned by *Bluetooth SIG, Inc.*, and any use of such marks by Honda Motor Co., Ltd., is under licence. Other trademarks and trade names are those of their respective owners.

HFT Limitations

An incoming call on HFT will interrupt the audio system when it is playing. It will resume when the call is ended.

Continued

HFT Status Display

The audio/information screen notifies you when there is an incoming call.

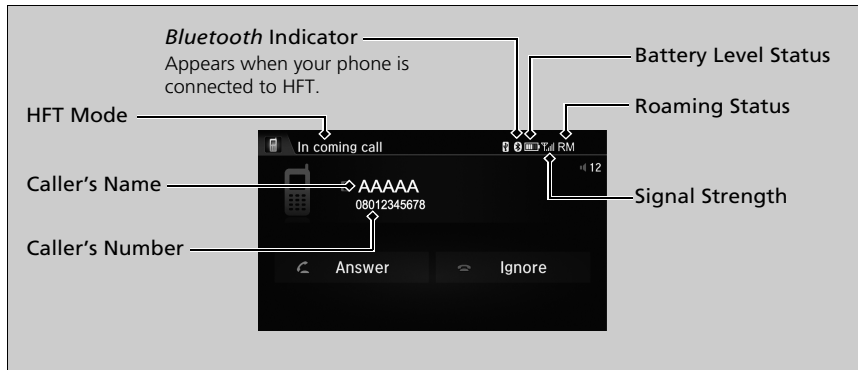

Limitations for Manual Operation

Certain manual functions are disabled or inoperable while the vehicle is in motion. You cannot select a grayed-out option until the vehicle is stopped.

Only previously stored speed dial entries with voice tags, phonebook names, or numbers can be called using voice commands while the vehicle is in motion.

➤ **Speed Dial** P. 376

HFT Status Display

The information that appears on the audio/information screen varies between phone models.

You can change the system language.

➤ **Customized Features*** P. 323

HFT Menus

The ignition switch must be in ACCESSORY **I** or ON **II***1 to use the system.

■ Phone settings screen

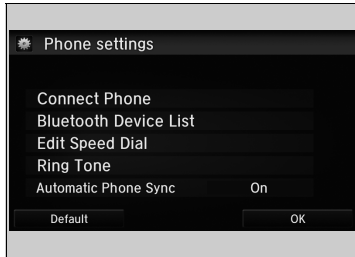

1. Press the button.
2. Select **Settings**.
3. Select **Phone**.

HFT Menu

To use HFT, you must first pair your *Bluetooth*-compatible mobile phone to the system while the vehicle is parked.

Some functions are limited while driving.

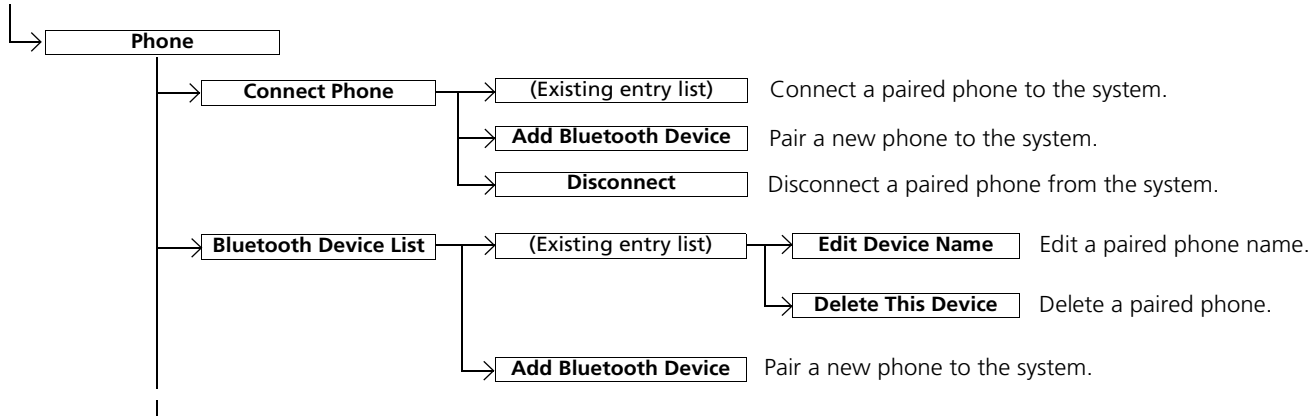

*1: Models with the keyless access system have an **ENGINE START/STOP** button instead of an ignition switch.

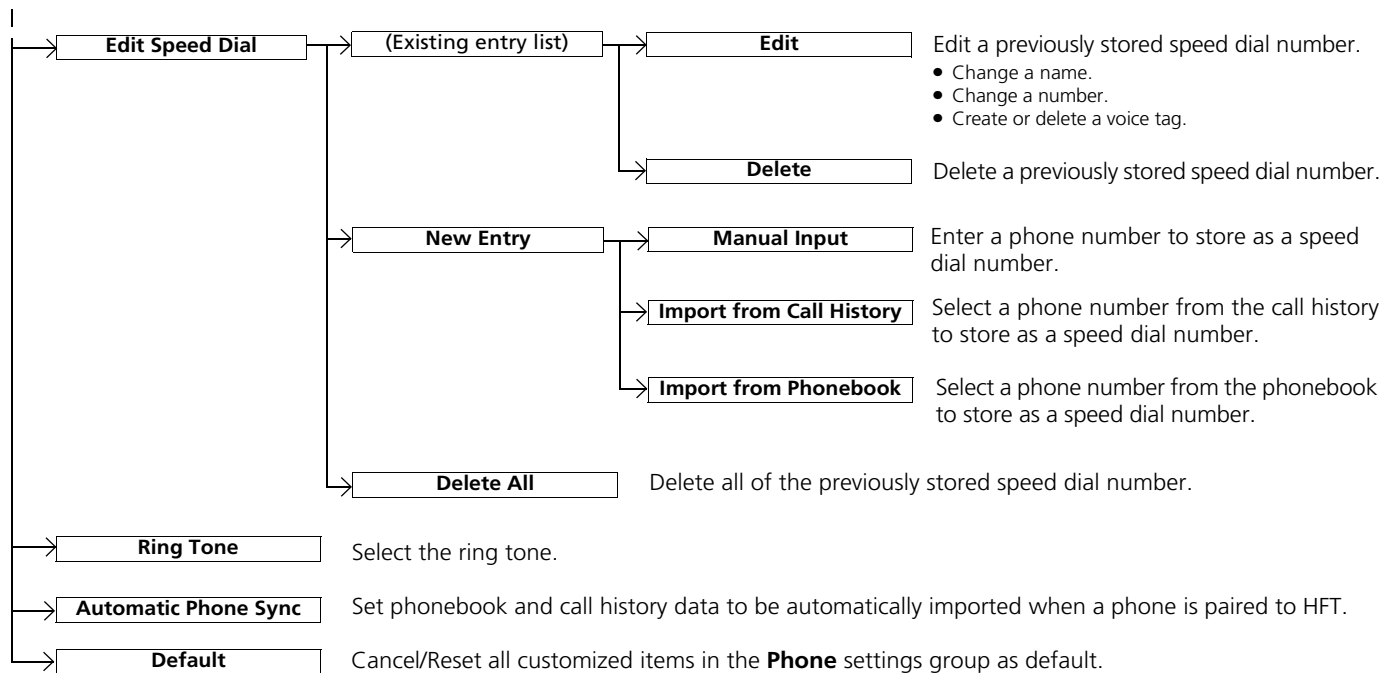

■ Phone Menu screen

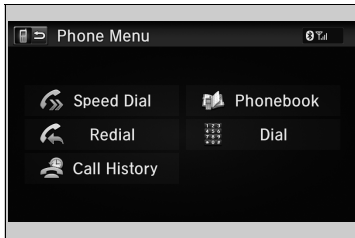

1. Press the  button.
2. Select **Phone**.
3. Press the  button.

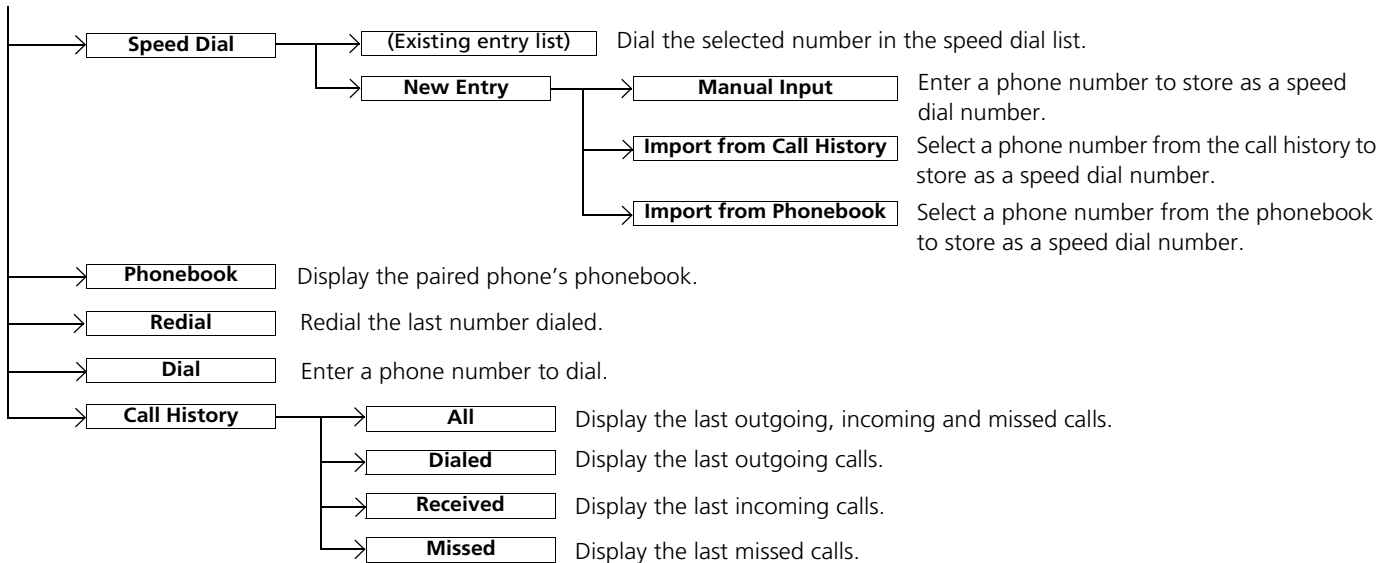

Continued

Phone Setup

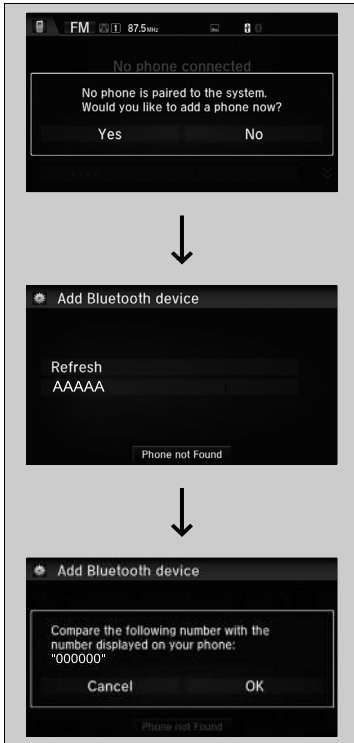

■ To pair a mobile phone (when there is no phone paired to the system)

1. Select **Phone**.
2. Select **Yes**.
3. Make sure your phone is search or discoverable mode, then select **Continue**.
 - ▶ HFT automatically searches for a *Bluetooth*® device.
4. Select your phone when it appears on the list.
 - ▶ If your phone does not appear, you can select **Refresh** to search again.
 - ▶ If your phone still does not appear, select **Phone not Found** and search for *Bluetooth*® devices using your phone. From your phone, search for **Honda HFT**.
5. The system gives you a pairing code on the audio/information screen.
 - ▶ Confirm if the pairing code on the screen and your phone match. This may vary by phone.

☒ Phone Setup

Your *Bluetooth*-compatible phone must be paired to the system before you can make and receive hands-free calls.

Phone Pairing Tips:

- You cannot pair your phone while the vehicle is moving.
- Up to six phones can be paired.
- Your phone's battery may drain faster when it is paired to the system.
- If your phone is not ready for pairing or not found by the system within three minutes, the system will time out and returns to idle.

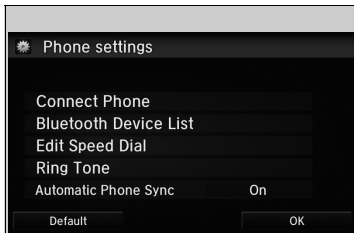

■ To change the currently paired phone

1. Go to the phone settings screen.
▶ **Phone settings screen** P. 367
2. Select **Connect Phone**.
3. Select a phone to connect.
▶ HFT disconnects the connected phone and starts searching for another paired phone.

■ To change the pairing code setting

1. Press the  button.
2. Select **Settings**.
3. Select **Bluetooth / Wi-Fi**.
4. Select the **Bluetooth** tab.
5. Select **Edit Pairing Code**.
6. Select **Random** or **Fixed**.

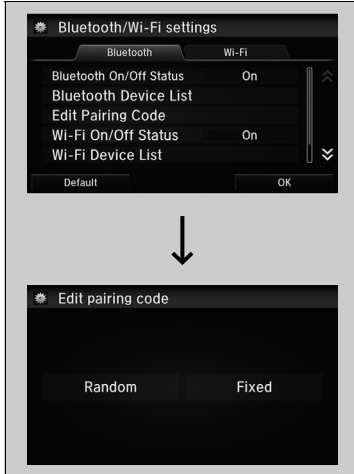

☒ To change the currently paired phone

If no other phones are found or paired when trying to switch to another phone, HFT will inform you that the original phone is connected again.

To pair other phones, select **Add Bluetooth Device** from the **Connect Phone** screen.

☒ To change the pairing code setting

The default pairing code is **0000** until you change the setting.

To create your own, select **Fixed**, and delete the current code, then enter a new one.

For a randomly generated pairing code each time you pair a phone, select **Random**.

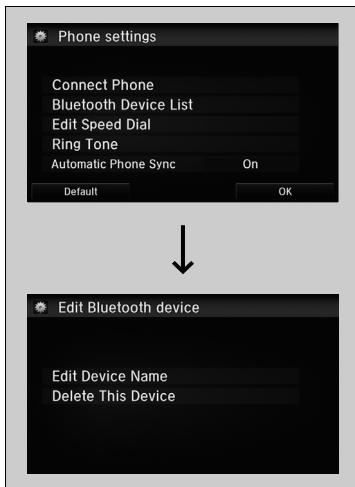

■ **To edit an already-paired phone name**

1. Go to the phone settings screen.
 - ▶ **Phone settings screen** P. 367
2. Select **Bluetooth Device List**.
3. Select a paired phone you want to edit.
4. Select **Edit Device Name**.
5. Edit the name and select **OK**.

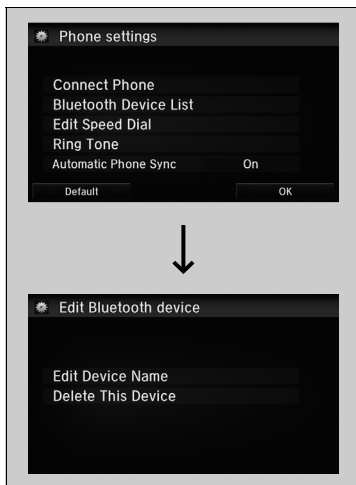

■ To delete a paired phone

1. Go to the phone settings screen.
 - ▶ **Phone settings screen** P. 367
2. Select **Bluetooth Device List**.
3. Select a phone you want to delete.
4. Select **Delete This Device**.
5. A confirmation message appears on the screen. Select **Yes**.

Ring Tone

You can change the ring tone setting.

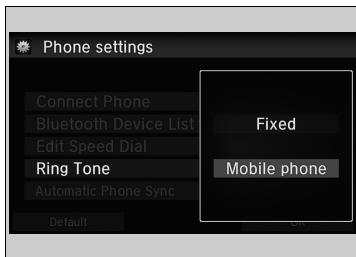

1. Go to the phone settings screen.
▶ **Phone settings screen** P. 367
2. Select **Ring Tone**.
3. Select **Fixed** or **Mobile phone**.

Ring Tone

Fixed: The fixed ring tone sounds from the speakers.
Mobile phone: The ring tone stored in the connected mobile phone sounds from the speakers.

Automatic Import of Cellular Phonebook and Call History

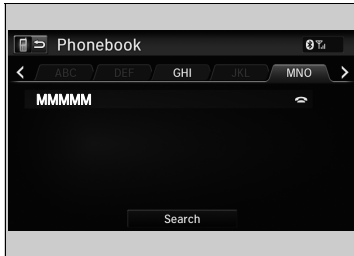

■ When Automatic Phone Sync is set to On:

When your phone is paired, the contents of its phonebook and call history are automatically imported to the system.

■ Changing the Automatic Phone Sync setting

1. Go to the phone settings screen.
 - ▶ **Phone settings screen** P. 367
2. Select **Automatic Phone Sync**.
3. Select **On** or **Off**.

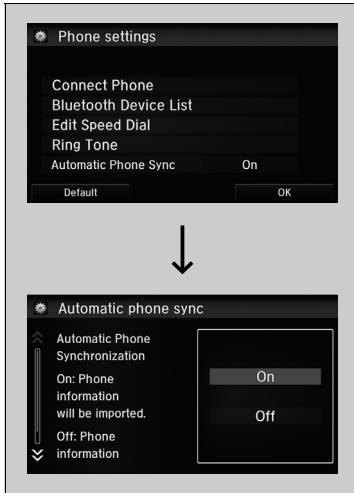

▶ Automatic Import of Cellular Phonebook and Call History

When you select a name from the list in the cellular phonebook, you can see up to three category icons. The icons indicate what types of numbers are stored for that name.

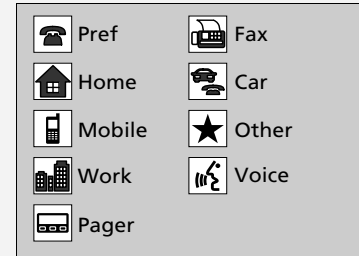

On some phones, it may not be possible to import the category icons to the system.

The phonebook is updated after every connection. Call history is updated after every connection or call.

■ Speed Dial

Up to 20 speed dial numbers can be stored per phone.

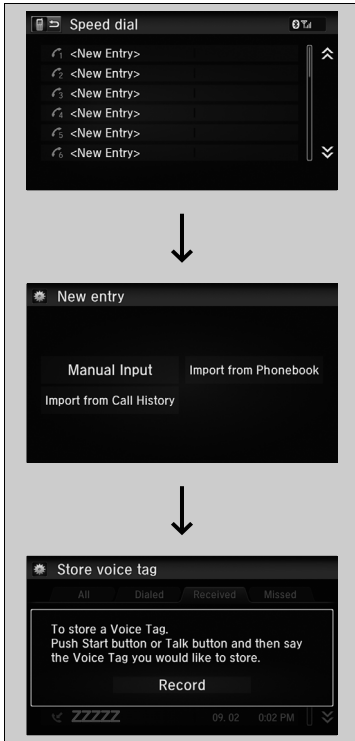

To store a speed dial number:

1. Go to the **Phone Menu** screen.
 - ▶ **Phone Menu screen** P. 369
2. Select **Speed Dial**.
3. Select **New Entry**.
4. Select a place to choose a number.
 - From **Import from Call History**:
 - ▶ Select a number from the call history.
 - From **Manual Input**:
 - ▶ Input the number manually.
 - From **Import from Phonebook**:
 - ▶ Select a number from the connected mobile phone's imported phonebook.
5. When the speed dial is successfully stored, you are asked to create a voice tag for the number. Select **Yes** or **No**.
6. Select **Record** to store a voice tag for the speed dial entry.
 - ▶ Using the  button, follow the prompts to store a voice tag for the speed dial entry.

▶▶ Speed Dial

When a voice tag is stored, press the  button to call the number using the voice tag. Say the voice tag name.

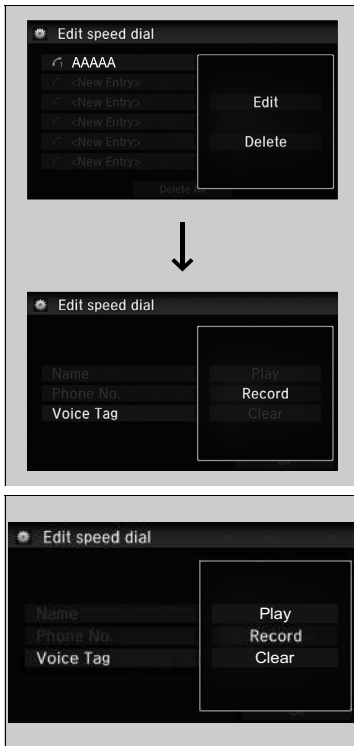

■ To add a voice tag to a stored speed dial number

1. Go to the phone settings screen.
▶ **Phone settings screen** P. 367
2. Select **Edit Speed Dial**.
3. Select an existing speed dial entry.
▶ From the pop-up menu, select **Edit**.
4. Select **Voice Tag**.
▶ From the pop-up menu, select **Record**.
5. Select **Record** to store the voice tag.
6. Using the  button, follow the prompts to complete the voice tag.

■ To delete a voice tag

1. Go to the phone settings screen.
▶ **Phone settings screen** P. 367
2. Select **Edit Speed Dial**.
3. Select an existing speed dial entry.
▶ From the pop-up menu, select **Edit**.
4. Select **Voice Tag**.
▶ From the pop-up menu, select **Clear**.
5. A confirmation message appears on the screen. Select **Yes**.

☒ Speed Dial

Avoid using duplicate voice tags.

Avoid using "home" as a voice tag.

It is easier for the system to recognise a longer name.

For example, use "John Smith" instead of "John."

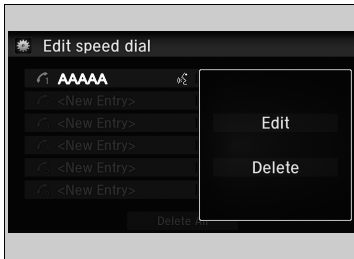

■ **To edit a speed dial**

1. Go to the phone settings screen.
 - ▶ **Phone settings screen** P. 367
2. Select **Edit Speed Dial**.
3. Select an existing speed dial entry.
 - ▶ From the pop-up menu, select **Edit**.
4. Select a setting you want.

■ **To delete a speed dial**

1. Go to the phone settings screen.
 - ▶ **Phone settings screen** P. 367
2. Select **Edit Speed Dial**.
3. Select an existing speed dial entry.
 - ▶ From the pop-up menu, select **Delete**.
4. A confirmation message appears on the screen. Select **Yes**.

■ **Making a Call**

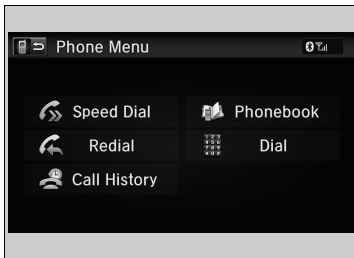

You can make calls by inputting any phone number, or by using the imported phonebook, call history, speed dial entries, or redial.

▶▶ Making a Call

Any voice-tagged speed dial entry can be dialed by voice from most screens.

Press the  button and say the voice tag name.

Once a call is connected, you can hear the voice of the person you are calling through the audio speakers.

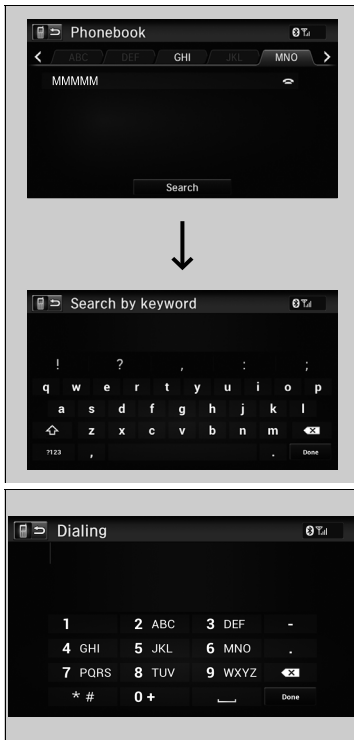

■ To make a call using the imported phonebook

1. Go to the **Phone Menu** screen.
 - ▶ **Phone Menu screen** P. 369
2. Select **Phonebook**.
3. Select a name.
 - ▶ You can also search by letter. Select **Search**.
 - ▶ Use the keyboard on the touch screen for entering letters.
4. Select a number.
 - ▶ Dialing starts automatically.

■ To make a call using a phone number

1. Go to the **Phone Menu** screen.
 - ▶ **Phone Menu screen** P. 369
2. Select **Dial**.
3. Select a number.
 - ▶ Use the keyboard on the touch screen for entering numbers.
4. Select **Done**.
 - ▶ Dialing starts automatically.

☒ To make a call using the imported phonebook

You can call a stored voice-tagged speed dial number using voice commands.

- ▶ **Speed Dial** P. 376

☒ To make a call using a phone number

You can call a stored voice-tagged speed dial number using voice commands.

- ▶ **Speed Dial** P. 376

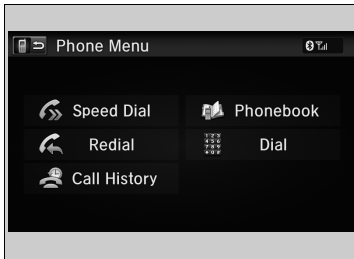

■ **To make a call using redial**

1. Go to the **Phone Menu** screen.
 - ▶ **Phone Menu screen** P. 369
2. Select **Redial**.
 - ▶ Dialing starts automatically.

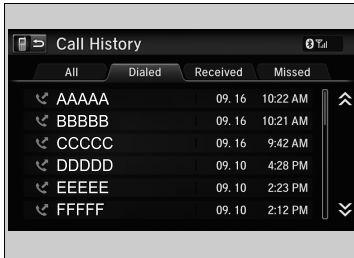

■ **To make a call using the Call History**

Call history is stored by **All, Dialed, Received, and Missed**.

1. Go to the **Phone Menu** screen.
 - ▶ **Phone Menu screen** P. 369
2. Select **Call History**.
3. Select **All, Dialed, Received, or Missed**.
4. Select a number.
 - ▶ Dialing starts automatically.

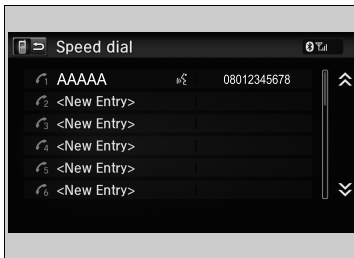

■ **To make a call using a Speed Dial entry**

1. Go to the **Phone Menu** screen.
 - ▶ **Phone Menu screen** P. 369
2. Select **Speed Dial**.
3. Select a number.
 - ▶ Dialing starts automatically.

▶▶ To make a call using redial

Press and hold the button to redial the last number dialed.

▶▶ To make a call using the Call History

The call history displays the last 20 all, dialed, received, or missed calls. (Appears only when a phone is connected to the system.)

▶▶ To make a call using a Speed Dial entry

When a voice tag is stored, press the button to call the number using the voice tag.



▶ **Speed Dial** P. 376

Any voice-tagged speed dial entry can be dialed by voice from any screen. Press the button and follow the prompts.

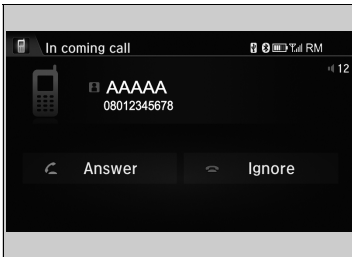
Receiving a Call



When there is an incoming call, an audible notification sounds (if activated) and the **Incoming call** screen appears.

Press the  button to answer the call.
Press the  button to decline or end the call.

Options During a Call

The following options are available during a call.

Mute: Mute your voice.

Transfer: Transfer a call from the system to your phone.

Touch Tones: Send numbers during a call. This is useful when you call a menu-driven phone system.

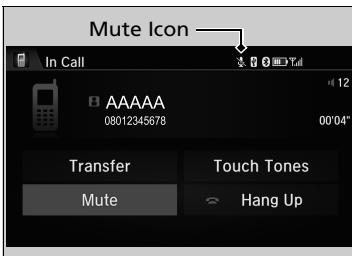

The available options are shown on the lower half of the screen.

Select the option.

- ▶ The mute icon appears when **Mute** is selected. Select **Mute** again to turn it off.

Receiving a Call



Call Waiting

Press the  button to put the current call on hold to answer the incoming call.

Press the  button again to return to the current call.

Select **Ignore** to ignore the incoming call if you do not want to answer it.

Press the  button if you want to hang up the current call.

You can select the icons on the audio/information screen instead of the  and  buttons.

Options During a Call

Touch Tones: Available on some phones.

You can select the icons on the audio/information screen.



Driving

This chapter discusses driving, refueling, and information on items such as accessories.

Before Driving			
Driving Preparation	384		
Load Limit	387		
Towing a Trailer			
Towing Preparation.....	388		
Driving Safely with a Trailer	392		
Off-road Guidelines	395		
When Driving			
Starting the Engine	397, 400		
Precautions While Driving.....	404		
Automatic Transmission*	405		
Shifting	406, 411, 420		
Auto Idle Stop.....	423, 427		
ECON Button	430		
Cruise Control*	431		
		Adjustable Speed Limiter.....	435
		Adaptive Cruise Control (ACC)*	441
		Forward Collision Warning*	455
		Lane Departure Warning*	459
		Traffic Sign Recognition System*	463
		Lane Keeping Assist System (LKAS)*	470
		Vehicle Stability Assist (VSA) System	478
		Adjusting Headlight Distribution	480
		Blind Spot Information System*	481
		Deflation Warning System.....	484
		REAL TIME AWD with Intelligent Control System*	486
		Braking	
		Brake System	487
		Anti-lock Brake System (ABS)	490
		Brake Assist System	491
		Emergency Stop Signal	492
		Collision Mitigation Braking System (CMBS)*	493
		City-Brake Active system*	502
		Parking Your Vehicle	
		When Stopped	507
		Parking Sensor System*	509
		Cross Traffic Monitor*	513
		Rearview Camera*	518
		Multi-View Rear Camera*	519
		Refueling	
		Fuel Information	522, 523
		How to Refuel	524, 525
		Fuel Economy and CO₂ Emissions	526

* Not available on all models

Driving Preparation

Check the following items before you start driving.

Exterior Checks

- Make sure there are no obstructions on the windows, door mirrors, exterior lights, or other parts of the vehicle.
 - ▶ Remove any frost, snow, or ice.
 - ▶ Remove any snow on the roof, as this can slip down and obstruct your field of vision while driving. If frozen solid, remove ice once it has softened.
 - ▶ When removing ice from around the wheels, be sure not to damage the wheel or wheel components.
- Make sure the bonnet is securely closed.
 - ▶ If the bonnet opens while driving, your front view will be blocked.
- Make sure the tyres are in good condition.
 - ▶ Check air pressures, check for damage and excessive wear.
 - 📄 **Checking and Maintaining Tyres** P. 580
- Make sure there are no people or objects behind or around the vehicle.
 - ▶ There are blind spots from the inside.

Exterior Checks

NOTICE

When doors are frozen shut, use warm water around the door edges to melt any ice. Do not try to force them open, as this can damage the rubber trim around the doors. When done, wipe dry to avoid further freezing.

Do not pour warm water into the key cylinder. You will be unable to insert the key if the water freezes in the hole.

Heat from the engine and exhaust can ignite flammable materials left under the bonnet, causing a fire. If you've parked your vehicle for an extended period, inspect and remove any debris that may have collected, such as dried grass and leaves that have fallen or have been carried in for use as a nest by a small animal. Also check under the bonnet for leftover flammable materials after you or someone else has performed maintenance on your vehicle.

Interior Checks

- Store or secure all items on board properly.
 - ▶ Carrying too much luggage, or improperly storing it, can affect your vehicle's handling, stability, stopping distance, and tyres, and make it unsafe.
 - **Load Limit** P. 387
- Do not pile items higher than the seat height.
 - ▶ They can block your view and may be thrown forward in the event of sudden braking.
- Do not place anything in the front seat footwells. Make sure to secure the floor mat*.
 - ▶ An object or unsecured floor mat can interfere with your brake and accelerator pedal operation while driving.
- If you have any animals on board, do not let them move around in the vehicle.
 - ▶ They may interfere with driving and a crash could occur.
- Securely close and lock all doors and the tailgate.
- Adjust your seating position properly.
 - ▶ Adjust the head restraint, too.
 - **Adjusting the Seats** P. 210
 - **Adjusting the Head Restraints** P. 213
- Adjust the mirrors and steering wheel properly for your driving.
 - ▶ Adjust them while sitting in the proper driving position.
 - **Adjusting the Mirrors** P. 206
 - **Adjusting the Steering Wheel** P. 205

Interior Checks

The headlight aim is set by the factory, and does not need to be adjusted. However, if you regularly carry heavy items in the luggage area or tow a trailer, have the aiming readjusted at a dealer or by a qualified technician.

Models with headlight adjuster

You can adjust the low beam headlight angle by your self.

➤ **Headlight Adjuster*** P. 193

Models with high voltage discharge tube bulbs

Your vehicle is equipped with the automatic headlight adjusting system that automatically adjusts the vertical angle of the low beam headlights.

* Not available on all models

- Be sure items placed on the floor behind the front seats cannot roll under the seats.
 - ▶ They can interfere with the driver's ability to operate the pedals, or the operation of the seats.
- Everyone in the vehicle must fasten their seat belt.
 - 📄 **Fastening a Seat Belt** P. 43
- Make sure that the indicators in the instrument panel come on when you start the vehicle, and go off soon after.
 - ▶ Always have a dealer check the vehicle if a problem is indicated.
 - 📄 **Indicators** P. 84

Load Limit

When you load luggage, the total weight of the vehicle, all passengers, and luggage must not exceed the maximum permissible weight.

📄 **Specifications** P. 652, 655

The load for the front and rear axles also must not exceed the maximum permissible axle weight.

📄 **Specifications** P. 652, 655

📄 Load Limit

⚠ WARNING

Overloading or improper loading can affect handling and stability and cause a crash in which you can be hurt or killed.

Follow all load limits and other loading guidelines in this manual.

Towing Preparation

Towing Load Limits

Your vehicle can tow a trailer if you carefully observe the load limits, use the proper equipment, and follow the towing guidelines. Check the load limits before driving.

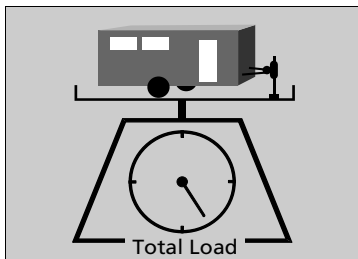

■ Total trailer weight

Do not exceed the maximum towing weight of the trailer and towbar (with/without brakes), luggage and everything in or on it.

Towing loads in excess of the maximum towing weight can seriously affect vehicle handling and performance and can damage the engine and drivetrain.

☒ Towing Load Limits

⚠ WARNING

Exceeding any load limit or improperly loading your vehicle and trailer can cause a crash in which you can be seriously hurt or killed.

Check the loading of your vehicle and trailer carefully before starting to drive.

Check if all loads are within limits at a public scale. If a public scale is not available, add the estimated weight of your luggage load to the weight of your trailer (as quoted by the manufacturer), and the trailer nose load.

Break-in Period

Avoid towing a trailer during your vehicle's first 1,000 km (625 miles).

If you tow a trailer in mountainous conditions, remember to reduce 10% of the combined vehicle and trailer weights from the maximum towing weight for every 1,000 metres of elevation.

Never exceed the maximum towing weight and any specified load limit.

☒ **Specifications** P. 654, 657

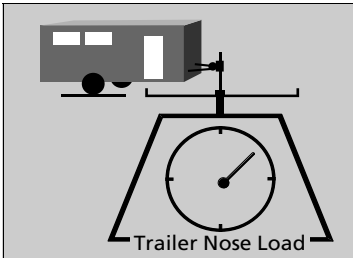

■ Trailer Nose load

The trailer nose load should never exceed 100 kg (220 lbs). This is the amount of weight the trailer puts on the towbar when it is fully-loaded. As a rule of thumb for trailer weights of less than 1,000 kg (2,205 lbs), the trailer nose load should be 10 percent of the total trailer package.

- Excessive trailer nose load reduces front tyre traction and steering control. Too little trailer nose load can make the trailer unstable and cause it to sway.
- To achieve a proper trailer nose load, start by loading 60% of the load toward the front of the trailer and 40% toward the rear. Readjust the load as needed.

■ Towing Equipment and Accessories

Towing equipment varies by the size of your trailer, how much load you are towing, and where you are towing.

■ Towbars

The towbar must be of an approved type and properly bolted to the underbody.

■ Safety chains

Always use safety chains when you tow a trailer. Leave enough slack to allow the trailer to turn corners easily, but do not allow the chains to drag on the ground.

■ Trailer brakes

If you are thinking of getting a trailer that has brakes, be sure they are electronically actuated. Do not attempt to tap into your vehicle's hydraulic system. No matter how successful it may seem, any attempt to attach trailer brakes to your vehicle's hydraulic system will lower braking effectiveness and create a potential hazard.

■ Additional towing equipment

There may be laws requiring special outside mirrors when towing a trailer. Even if mirrors are not required in your locale, you should install special mirrors if visibility is restricted in any way.

■ Trailer light

Trailer lights and equipment must comply with the regulations of the country where you are driving. Check with your local trailer sales or rental agency for the requirements in the area where you plan to tow.

▣ Towing Equipment and Accessories

Make sure that all equipment is properly installed and maintained, and that it meets the country's regulations where you are driving.

Consult your trailer sales or rental agency if any other items are recommended or required for your towing situation.

The lighting and wiring of trailers can vary by type and brand. If a connector is required, it should only be installed by a qualified technician.

Trailer Stability Assist

Helps to stabilize the vehicle and trailer when the trailer severely sways.

■ How trailer stability assist works

When the vehicle and trailer become unstable while driving, trailer stability assist determines the cause. If the trailer oscillation is detected as the cause, and the swaying increases, the system applies the brakes or controls engine output to reduce vehicle speed.

Both the vehicle and trailer brake lights come on automatically if you brake to reduce vehicle speed.

▣ Trailer Stability Assist

Trailer stability assist is not a function that prevents the vehicle and trailer from swaying. Avoid high speeds, abrupt steering, improper trailer load, and sudden braking to keep the trailer from swaying. When swayed too severely, the system becomes ineffective, and you may lose control of your vehicle, causing the trailer to roll over or get damaged.

▣ **Driving Safely with a Trailer** P. 392

Trailer towing sway is caused by:

- Crosswinds
- Improper towbar down load
- Excessive Speed

The VSA system indicator blinks during the trailer stability assist operation.

▣ **VSA Operation** P. 478

Driving Safely with a Trailer

■ Things You Need To Know Before Towing a Trailer

- Have the trailer properly serviced and keep it in good condition.
- Make sure that all the weights and load in the vehicle and trailer are within limits.
 - ✎ **Towing Load Limits** P. 388
- Securely attach the tow bar, safety chains, and other necessary parts to the trailer.
- Securely store all the items in and on the trailer so that they do not shift while driving.
- Check if the lights and brakes on the trailer are working properly.
- Check the pressures of the trailer tyres, including the spare.
- Check regulations concerning the maximum speed or driving restrictions for vehicles towing trailers. If you are driving across several countries, check each country's requirements before leaving home, because regulations may vary.

■ Models with Auto Idle Stop

- Turn off Auto Idle Stop system using Auto Idle Stop **OFF** button. The trailer weight can affect your vehicle's brake effectiveness if Auto Idle Stop is activated on a hill while towing a trailer.

✎ Driving Safely with a Trailer

Operating speed when towing a trailer is restricted up to 100 km/h (62 mph).

Parking

In addition to the normal precautions, place wheel chocks at each of the trailer's tyres.

We recommend you drive uphill of less than 12% slope. Follow the trailer association's recommendations for suitable roads.

Winds caused by passing large vehicles can sway your trailer, keep a constant speed and steer straight ahead.

Always drive slowly and have someone guide you when reversing.

Towing Speeds and Gears

- Drive slower than normal.
- Obey posted speed limits for vehicles with trailers.

Automatic transmission models

- Use the **D** position when towing a trailer on level roads.

Manual transmission models

Either shift up or shift down indicator will come on at the best time to shift to a higher or lower gear for the better fuel economy.

⌘ Towing Speeds and Gears

The shift down indicator will not prompt to downshift to 1st gear. It is up to you to downshift to 1st gear to increase engine braking. Avoid sudden engine braking.

Road and traffic conditions may require you to shift at times other than those indicated.

Continued

■ Turning and Braking

- Turn more slowly and with a wider turning arc than normal.
- Allow more time and distance for braking.
- Do not brake or turn suddenly.

■ Driving in Hilly Terrain

- Closely watch your temperature gauge. If it nears the red (Hot) mark, turn off the climate control system and reduce speed. Pull to the side of the road safely to cool down the engine if necessary.

Automatic transmission models

- Change the gear position to the **S** position if the transmission shifts frequently.

General Information

Your vehicle has been designed primarily for use on pavement, however, its higher ground clearance allows you to occasionally travel on unpaved roads. It is not designed for trail-blazing, or other challenging off-road activities.

If you decide to drive on unpaved roads, you will find that it requires somewhat different driving skills and that your vehicle will handle somewhat differently than it does on pavement. Pay attention to the precautions and tips in this section, and get acquainted with your vehicle before leaving the pavement.

Important Safety Precautions

To avoid loss of control or rollover, be sure to follow all precautions and recommendations:

- Be sure to store luggage properly and do not exceed your luggage load limits.
 - **Specifications** P. 652, 655
- Whenever you drive, make sure you and your passengers always wear seat belts.
- Keep your speed low, and never go faster than the conditions allow.
- It's up to you to continually assess the situation and drive within the limits.

Off-road Guidelines

⚠ WARNING

Improperly operating this vehicle on or off pavement can cause an accident or rollover in which you and your passengers could be seriously injured or killed.

- Follow all instructions and guidelines in this owner's manual.
- Keep your speed low, and don't drive faster than conditions permit.

Failure to operate your vehicle correctly might result in a crash or a rollover.

- **Important Handling Information** P. 36
- **Precautions While Driving** P. 404

Avoiding Trouble

- **Check Out Your Vehicle** before you leave the pavement and make sure that all scheduled maintenance has been completed. Pay special attention to the condition of the tyres, and check the tyre pressures.
- **Remember** the route you choose presents limits (too steep or bumpy), you have limits (driving skill and comfort), and your vehicle has limits (traction, stability, and power). Failing to recognize these limits will likely put you and your passengers in a hazardous situation.
- **Accelerating and Braking** should be done slowly and gradually. Trying to start or stop too fast can cause a loss of traction and you could lose control.
- **Avoiding Obstacles and Debris** in the road reduces the likelihood of a rollover or damage to your suspension or other components.
- **Driving on Slopes** increasing your risk of a rollover, particularly if you attempt to drive across a slope that is too steep. Going straight or down a slope is usually the safest. If you can't clearly see all conditions or obstacles on a slope, walk it before you drive it. If there is any doubt whether you can safely pass, don't try it. Find another route. If you get stuck when climbing, do not try to turn around. Back down slowly following the same route you took up the hill.
- **Crossing a Stream** - Avoid driving through deep water. If you encounter water in your route (a small stream or large puddle, for example), evaluate it carefully before going ahead. Make sure it is shallow, flowing slowly, and has firm ground underneath. If you are not sure of the depth or the ground, turn around and find another route. Driving through deep water can also damage your vehicle. The water can get into the transmission and differential, diluting the lubricant and causing an eventual failure. It can also wash the grease out of the wheel bearings.
- **If You Get Stuck**, carefully go in the direction that you think will get you unstuck. Do not spin the tyres as this will only make things worse and could damage the transmission. If you are unable to free yourself, your vehicle will need to be towed. Front and rear tow hooks are provided for this purpose.

Models without keyless access system

Starting the Engine

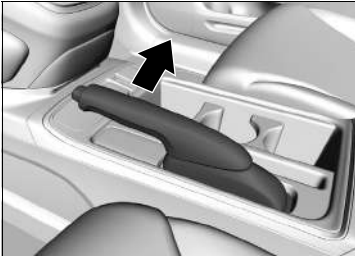

1. Make sure the parking brake is applied.

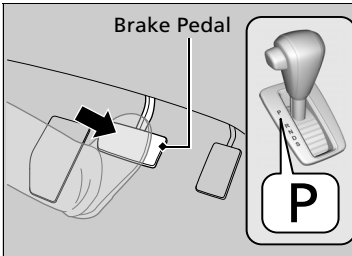

5-speed automatic transmission models

2. Check that the shift lever is in **P**, then depress the brake pedal.
 - ▶ Although it is possible to start the vehicle in **N**, it is safer to start it in **P**.

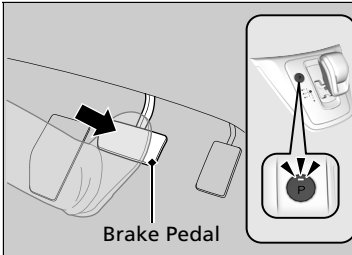

9-speed automatic transmission models

2. Depress the brake pedal.
 - ▶ Make sure the transmission is in **P**.

Starting the Engine

Keep your foot firmly on the brake pedal when starting the engine.

Petrol models

The engine is harder to start in cold weather and in thinner air found at altitudes above 2,400 metres (8,000 feet).

When starting the engine in cold weather, turn off all electrical accessories such as the lights, climate control system, and rear demister in order to reduce battery drain.

If the exhaust system sounds abnormal or you can smell exhaust gas inside the vehicle, have your vehicle checked by a dealer. There may be a problem with the engine or exhaust system.

The immobilizer system protects your vehicle from theft. If an improperly coded key (or other device) is used, the engine's fuel system is disabled.

▶ **Immobilizer System** P. 176

Continued

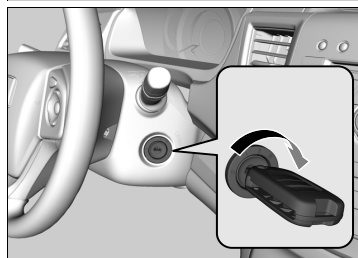
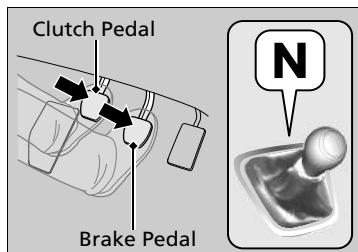

Manual transmission models

2. Check that the shift lever is in **N**. Then depress the brake pedal with your right foot, and the clutch pedal with your left foot.
 - ▶ The clutch pedal must be fully depressed to start the engine.
3. Turn the ignition switch to START **III** without depressing the accelerator pedal.

Starting the Engine

Do not hold the key in START **III** for more than 10 seconds.

- If the engine does not start right away, wait for at least 30 seconds before trying again.
- If the engine starts, but then immediately stops, wait at least 30 seconds before repeating step 3 while gently depressing the accelerator pedal. Release the accelerator pedal once the engine starts.

Diesel models

NOTICE

For proper lubrication, the engine must not be run above fast idle speed until the low oil pressure indicator goes off.

Avoid harsh acceleration or labouring the engine before the normal operating temperature has been reached.

Diesel models

When the engine malfunctions or stalls due to insufficient fuel, move the vehicle to a safe place immediately and refuel 10 Litres or more.

When fuel runs out, air enters the fuel system. This may cause slow starting of the engine.

If the engine does not start on the first try, try again a few times. If the engine still does not start, ask a dealer.

Starting to Drive

Automatic transmission models

1. Keeping your right foot on the brake pedal, release the parking brake. Check that the parking brake indicator has gone off.
 ➤ **Parking Brake** P. 487
2. Change the gear position to **[D]**. Select **[R]** when reversing.
3. Gradually release the brake pedal and gently depress the accelerator pedal to pull away.

Hill Start Assist System

Hill start assist keeps the brake engaged briefly to help prevent the vehicle from rolling on inclines as you move your foot from the brake pedal to the accelerator.

Manual transmission models

Depress the clutch pedal, and shift to one of the forward gears when facing uphill, or **[R]** when facing downhill, then release the brake pedal.

Automatic transmission models

Change the gear position to **[D]** or **[S]** when facing uphill, or **[R]** when facing downhill, then release the brake pedal.

The brakes remain engaged briefly as you release the brake pedal.

⚠Hill Start Assist System

Hill start assist may not prevent the vehicle from rolling downhill on a very steep or slippery slope, and will not operate on small inclines.

Hill start assist is not a replacement for the parking brake.

Models with keyless access system

Starting the Engine

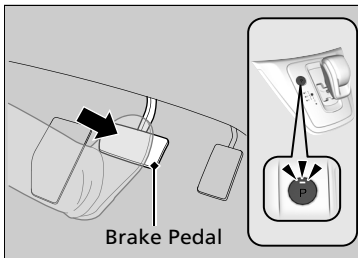
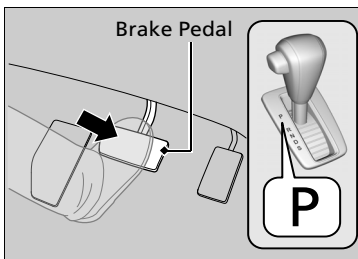
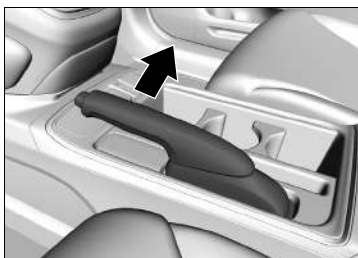

1. Make sure the parking brake is applied.

5-speed automatic transmission models

2. Check that the shift lever is in **P**, then depress the brake pedal.

▶ Although it is possible to start the vehicle in **N**, it is safer to start it in **P**.

9-speed automatic transmission models

2. Depress the brake pedal.

▶ Make sure the transmission is in **P**.

Starting the Engine

Keep your foot firmly on the brake pedal when starting the engine.

Petrol models

The engine is harder to start in cold weather and in thinner air found at altitudes above 2,400 metres (8,000 feet).

When starting the engine in cold weather, turn off all electrical accessories such as the lights, climate control system, and rear demister in order to reduce battery drain.

If exhaust system sounds abnormal or you can smell exhaust gas inside the vehicle, have your vehicle checked by a dealer. There may be a problem with the engine or exhaust system.

The immobilizer system protects your vehicle from theft. If an improperly coded key (or other device) is used, the engine's fuel system is disabled.

➤ **Immobilizer System** P. 176

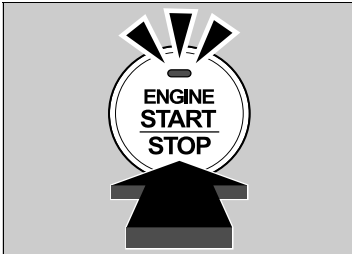
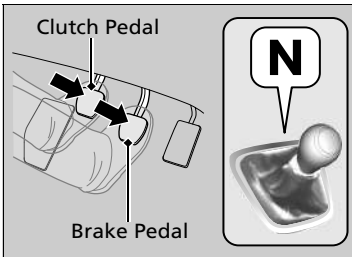
**Manual transmission models**

2. Check that the shift lever is in **N**. Then depress the brake pedal with your right foot, and the clutch pedal with your left foot.
 - ▶ The clutch pedal must be fully depressed to start the engine.

All models

3. Press the **ENGINE START/STOP** button without depressing the accelerator pedal.

Starting the Engine

Bring the keyless remote close to the **ENGINE START/STOP** button if the battery in the keyless remote is weak.

▶ **If the Keyless Remote Battery is Weak** P. 623

The engine may not start if the keyless remote is subjected to strong radio waves.

Do not hold the **ENGINE START/STOP** button to start the engine.

If the engine does not start, wait at least 30 seconds before trying again.

Diesel models**NOTICE**

For proper lubrication, the engine must not be run above fast idle speed until the oil pressure warning indicator goes off.

Avoid harsh acceleration or labouring the engine before the normal operating temperature has been reached.

Diesel models

When the engine malfunctions or stalls due to insufficient fuel, move the vehicle to a safe place immediately and refuel 10 Litres or more.

When fuel runs out, air enters the fuel system. This may cause slow starting of the engine.

If the engine does not start on the first try, try again a few times. If the engine still does not start, ask a dealer.

Continued

■ Stopping the Engine

You can turn the engine off when the vehicle is completely stopped.

Automatic transmission models

1. Change the gear position to **P**.
2. Press the **ENGINE START/STOP** button.

Manual transmission models

- If the shift lever is in **N**, press the **ENGINE START/STOP** button.
- If the shift lever is in any gear other than **N**, depress the clutch pedal, then press the **ENGINE START/STOP** button.

Starting to Drive

Automatic transmission models

1. Keeping your right foot on the brake pedal, release the parking brake. Check that the parking brake indicator has gone off.
 ➤ **Parking Brake** P. 487
2. Change the gear position to **[D]**. Select **[R]** when reversing.
3. Gradually release the brake pedal and gently depress the accelerator pedal to pull away.

Hill Start Assist System

Hill start assist helps to prevent the vehicle from rolling on inclines as you move your foot from the brake pedal to the accelerator.

Manual transmission models

Depress the clutch pedal, and shift to one of the forward gears when facing uphill, or **[R]** when facing downhill, then release the brake pedal.

Automatic transmission models

Change the gear position to **[D]** or **[S]** when facing uphill, or **[R]** when facing downhill, then release the brake pedal.

The brakes remain engaged briefly as you release the brake pedal.

Hill Start Assist System

Hill start assist may not prevent the vehicle from rolling downhill on a very steep or slippery slope, and does not operate on small inclines.

Hill start assist is not a replacement for the parking brake.

Precautions While Driving

In Rain

Avoid driving in deep water and on flooded roads. This can damage the engine or driveline, or cause electrical component failure.

Other Precautions

If there is a strong impact with something under the vehicle, stop in a safe location. Check the underside of the vehicle for damage or any fluid leaks.

Precautions While Driving

CAUTION: Do not drive on the road where water is deep. Driving through deep water will cause damage to the engine and electrical equipment and the vehicle will break down.

NOTICE

Do not change the gear position while pressing the accelerator pedal. You could damage the transmission.

If you repeatedly turn the steering wheel at an extremely low speed, or hold the steering wheel on the full left or right position for a while, the electric power steering (EPS) system heats up. The system goes into a protective mode, and limits its performance. The steering wheel becomes harder and harder to operate. Once the system cools down, the EPS system is restored. Repeated operation under these conditions can eventually damage the system.

Automatic Transmission *

■ Creeping

The engine runs at a higher idle speed and creeping increases. Keep the brake pedal firmly depressed when stopped.

■ Kickdown

Quickly depressing the accelerator pedal while driving uphill may cause the transmission to drop to a lower gear, unexpectedly increasing vehicle speed. Depress the accelerator pedal carefully, especially on slippery roads and curves.

⚠ Precautions While Driving

If the ignition switch is turned to ACCESSORY [I] or LOCK [0]*¹ while driving, the engine will shut down and all steering and brake power assist functions will stop, making it difficult to control the vehicle.

Do not change the gear position to [N], as you will lose engine braking (and acceleration) performance.

During the first 1,000 km (625 miles) of operation, avoid sudden acceleration or full throttle operation so as to not damage the engine or powertrain.

Avoid hard braking for the first 300 km (200 miles). You should also follow this when the brake pads are replaced.

*1: Models with the keyless access system have an **ENGINE START/STOP** button instead of an ignition switch.

* Not available on all models

5-speed automatic transmission models

Shifting

Change the shift position in accordance with your driving needs.

■ Shift lever positions

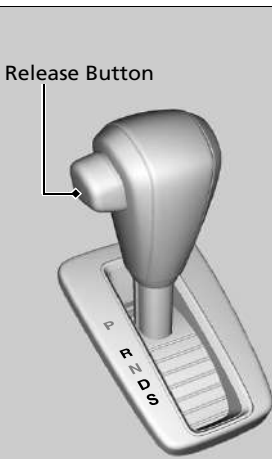

P **Park**
Used when parking or starting the engine

R **Reverse**
Used when reversing

N **Neutral**
Used when idling

D **Drive**
Used:
• For normal driving (gears change between 1st and 5th automatically)
• When temporarily driving in the sequential mode

S **Drive (S)**
Used for:
• Automatically changing gears between 1st and 4th (4th gear is used only at high speed)
• Driving in the sequential mode

▶ Shifting

You cannot turn the ignition switch to LOCK [0]*1 and remove the key unless the shift lever is in [P].

The vehicle may move forward very slightly even in [N] while the engine is cold. Depress the brake pedal firmly and, when necessary, apply the parking brake.

*1: Models with the keyless access system have an **ENGINE START/STOP** button instead of an ignition switch.

Shift Lever Operation

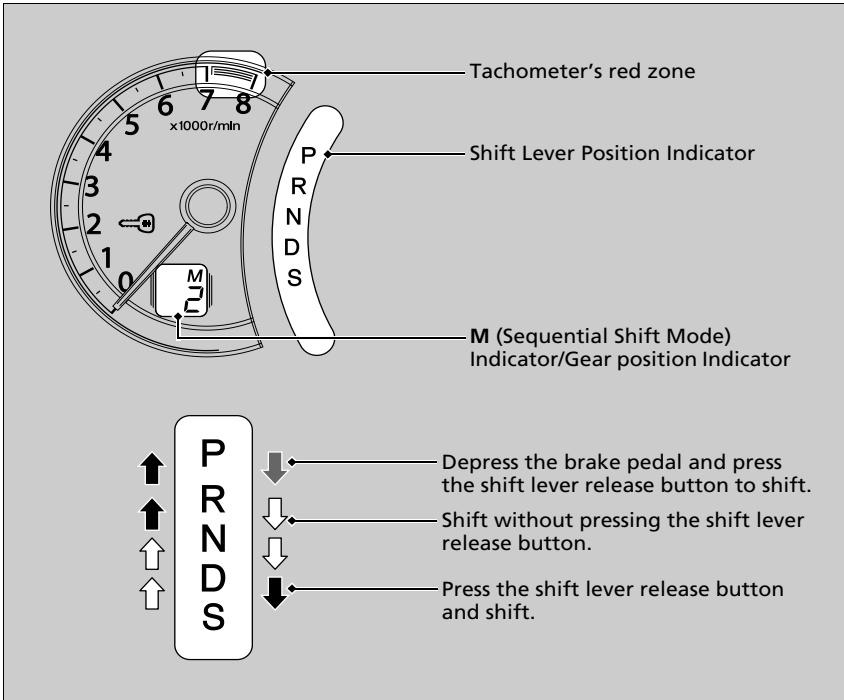

Shift Lever Operation

NOTICE

When you change the shift lever from **D** to **R** and vice versa, come to a complete stop and keep the brake pedal depressed. Operating the shift lever before the vehicle has come to a complete standstill can damage the transmission.

Use the shift lever position indicator to check the lever position before pulling away.

Whichever position the shift lever is in when driving, a blinking **D** indicator indicates a transmission problem. Avoid sudden acceleration and have the transmission checked by a dealer as soon as possible.

The fuel supply may be cut off if you drive at engine speeds in or over the tachometer's red zone (engine speed limit). If this happens, you may experience a slight jolt.

It may not be possible to operate the shift lever if the brake pedal is applied while the shift lever release button is held down. Depress the brake pedal first.

■ Sequential Shift Mode

Use the paddle shifters to change between 1st and 5th gears without removing your hands from the steering wheel. The transmission will switch to the sequential shift mode.

■ When the shift lever is in **[D]**:

The vehicle will go into the sequential shift mode momentarily, and the gear position indicator will come on.

Once you start travelling at a constant speed, the sequential shift mode will automatically switch off, and the gear position indicator will go off.

Hold the **[+]** paddle shifter for two seconds to return to normal drive.

■ When the shift lever is in **[S]**:

The vehicle will go into the sequential shift mode, and the **M** (sequential shift mode) indicator and gear position indicator will come on. At speeds of 10 km/h (6 mph) or less, the vehicle automatically shifts down into 1st gear. It will not automatically shift up, even if vehicle speed increases.

You can only pull away in 1st or 2nd gear.

When switching out of the sequential shift mode, move the shift lever from **[S]** to **[D]**. When the sequential shift mode is cancelled, the **M** indicator and gear position indicator go off.

■ Second gear lock mode

If you pull the **+** paddle shifter while stopped or driving at 10 km/h (6 mph) or less, the gear position will be locked in 2nd gear. This makes it easier to pull away on slippery surfaces such as snow covered roads.

To cancel the 2nd gear lock mode, pull the **-** paddle shifter, or move the shift lever from **[S]** to **[D]**.

■ Sequential Shift Mode Operation

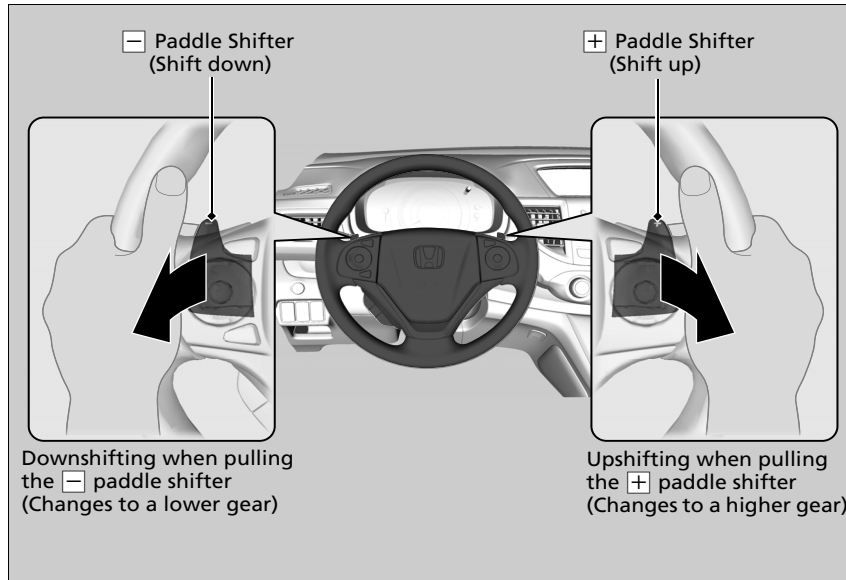

Continued

☒ Sequential Shift Mode Operation

Each paddle shift operation makes a single gear change.

To change gears continuously, release the paddle shifter before pulling it again for the next gear.

If the gear position indicator blinks when you try to shift up or down, this means your vehicle speed is not in its allowable gear shifting range. Slightly accelerate to shift up and decelerate to shift down while the indicator is blinking.

Shift Up Indicators

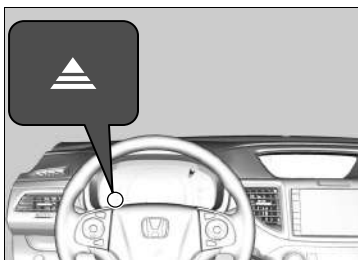

Come on while the vehicle is in the sequential shift mode to indicate when a gear change is appropriate to maintain the most fuel efficient driving style.

The shift up indicator: Comes on when shifting up is recommended.

Shift Up Indicators

⚠ WARNING

The shift indicator is only a guide to help you achieve better fuel economy. Never refer to the Shift Indicators when road and traffic conditions are unsuitable or when it may distract you.

When the ECON mode is on, ambient meter colour may change if you do not change gears when a shift indicator illuminates. This can result in a change in fuel economy.

Road and traffic conditions may require you to shift at times other than those indicated.

9-speed automatic transmission models

Shifting

Change the gear position in accordance with your driving needs.
Start the engine before you change the gear position.

■ Shift lever positions

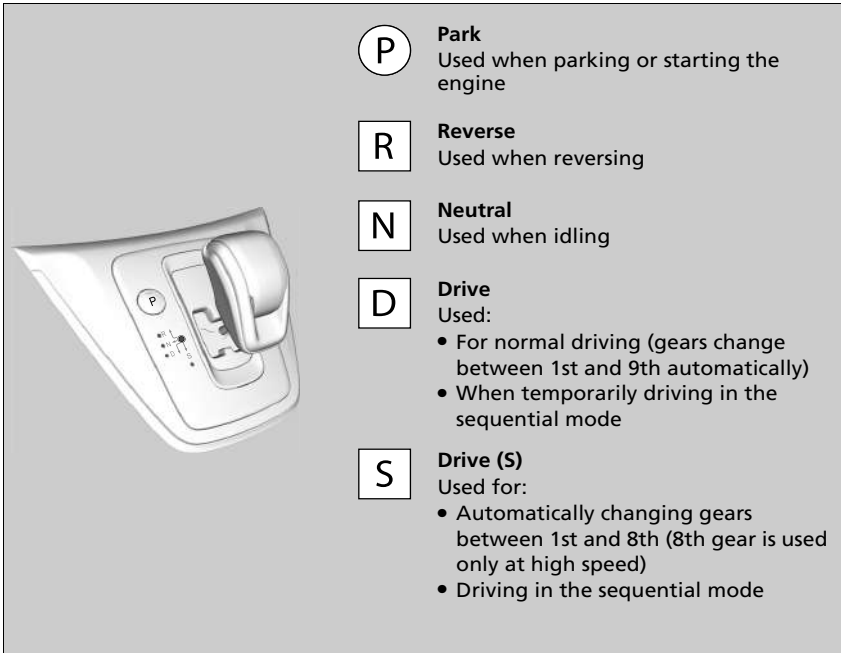

▶ Shifting

⚠ WARNING

The vehicle can roll away if left unattended without confirming that Park is engaged. Always keep your foot on the brake pedal until you have confirmed that **P** is shown on the gear position Indicator.

You cannot turn the ignition switch to LOCK **O***1 and remove the key unless the transmission is in **P**.

The vehicle may move forward very slightly even in **N** while the engine is cold. Depress the brake pedal firmly and, when necessary, apply the parking brake.

When shifting positions in extremely low temperatures (-30°C), there may be a short delay before the shift position is displayed. Always confirm you are in the correct shift position before driving.

The beeper sounds when you depress the accelerator pedal with the gear position in **N**. Change the gear position to **D** or **R** with the brake pedal depressed.

*1: Models with the keyless access system have an **ENGINE START/STOP** button instead of an ignition switch.

Continued

■ **P (Park) button**

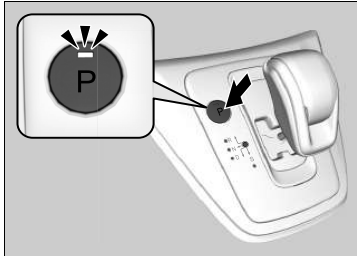

The gear position changes to **P** when you press the **P** button while the vehicle is parked with the ignition switch in ON **II***1. The indicator on the **P** button comes on.

*1: Models with the keyless access system have an **ENGINE START/STOP** button instead of an ignition switch.

Shift Lever Operation

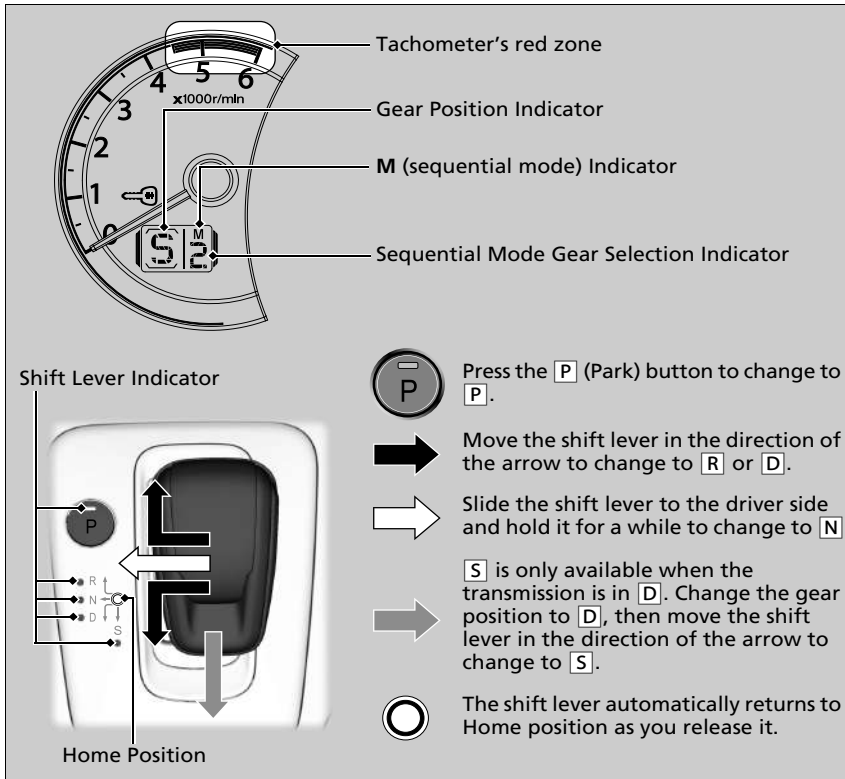

Shift Lever Operation

NOTICE

When you change the transmission position from **D** to **R** and vice versa, come to a complete stop and keep the brake pedal depressed. Operating the shift lever before the vehicle has come to a complete standstill can damage the transmission.

Use the gear position indicator and the shift lever indicator to check the gear position before selecting a gear position.

If the indicator of the currently selected gear position, or all segment of the gear position indicator is blinking, there is a problem with the transmission. Avoid sudden acceleration and have the transmission checked by a dealer as soon as possible.

The fuel supply may be cut off if you drive at engine speeds in or over the tachometer's red zone (engine speed limit). If this happens, you may experience a slight jolt.

The beeper sounds once when you change to **R**.

In freezing or sub-freezing conditions, the electronic gear selector response may be slow.

Always depress the brake pedal before changing the gear position to **P**, and confirm that **P** is shown on the gear position indicator before releasing the brake.

■ When opening the driver's door

If you open the driver's door under the following conditions, the gear position automatically changes to **P**.

- The vehicle is in stationary with the engine running, or moving at 2 km/h (1 mph) or slower.
- The transmission is in other than **P**.
- You have unfastened the driver side seat belt.

▶ If you manually change the gear position from **P** with the brake pedal depressed, the gear position will automatically return to **P** once you release the brake pedal.

■ When turning off the engine

If you turn the engine off while the vehicle is stationary, and the transmission is in other than **P**, the gear position automatically changes to **P**.

⚠ When opening the driver's door

You should always select **P** before opening the driver's door.

Make sure to park the vehicle in a safe place.

➡ **When Stopped** P. 507

If you want to drive the vehicle after the gear position has automatically changed to **P** under the described conditions, close the door, fasten the seat belt, depress the brake pedal, then change the gear position.

If you leave the vehicle, turn off the engine and lock the doors.

■ If you want to keep the transmission in **N** position [car wash mode]

With the engine running:

1. Press and hold the brake pedal.
2. Select **N**.

Models with keyless access system

3. Within five seconds, press the **ENGINE START/STOP** button.

The power mode changes to ACCESSORY.

- ▶ This puts the vehicle in car wash mode which must be used when your vehicle is pulled through a conveyor type automatic car wash where you or an attendant do not remain in the vehicle.
- ▶ The gear position remains in **N** with the power mode in ACCESSORY for 15 minutes, then, it automatically changes to **P** and the power mode changes to OFF.

Manually changing to **P** cancels ACCESSORY mode. The **P** indicator comes on and the power mode changes to OFF.

Models without keyless access system

3. Within five seconds, turn the ignition switch to ACCESSORY **I**.
 - ▶ This puts the vehicle in car wash mode which must be used when your vehicle is pulled through a conveyor type automatic car wash where you or an attendant do not remain in the vehicle.
 - ▶ The gear position remains in **N** with the ignition switch in ACCESSORY **I** for 15 minutes, then, it automatically changes to **P**.

■ Restriction on selecting a gear position

You cannot select a gear position under certain circumstances that may lead to unexpected accidents.

When the transmission is in:	1. Under the circumstances of that:	2. You cannot select:	3. The gear position remains in/changes to:	How to change the gear position
P	The brake pedal is not depressed. The accelerator pedal is depressed.	Other gear position.	P	Release the accelerator pedal and depress the brake pedal.
N	The vehicle is moving at low speed without the brake pedal depressed. The vehicle is moving at low speed with the accelerator pedal depressed.		N	
N, D or S	The vehicle is moving forward.	R	N	Stop your vehicle in a safe place, depress the brake pedal, and select the appropriate gear position.
R or N	The vehicle is moving backward.	D		
R, N, D or S	The vehicle is moving.	You cannot press the park button.	P or N	Select D , then shift to S .
R	–	S		
P or N	–			

Sequential Mode

Use the paddle shifters to change between 1st and 9th gears without removing your hands from the steering wheel. The transmission will switch to the sequential mode when you pull a paddle shifter while driving. This mode is useful when engine braking is needed.

■ When the transmission is in **D**:

The vehicle will go into the sequential mode momentarily, and the sequential mode gear selection indicator will come on.

Once you start travelling at a constant speed, the sequential mode will automatically switch off, and the sequential mode gear selection indicator will go off.

Hold the **+** paddle shifter for a few seconds to return to normal drive.

■ When the transmission is in **S**:

The vehicle will go into the sequential mode, and the **M** (sequential mode) indicator and sequential mode gear selection indicator will come on.

If the vehicle speed increases and the engine speed reaches near the tachometer's red zone, the transmission automatically shifts up to next gear.

You can cancel this mode by changing the gear position to **D**, or pulling the **+** paddle shifter for a few seconds. When the sequential mode is cancelled, the **M** indicator and sequential mode gear selection indicator go off.

Sequential Mode Operation

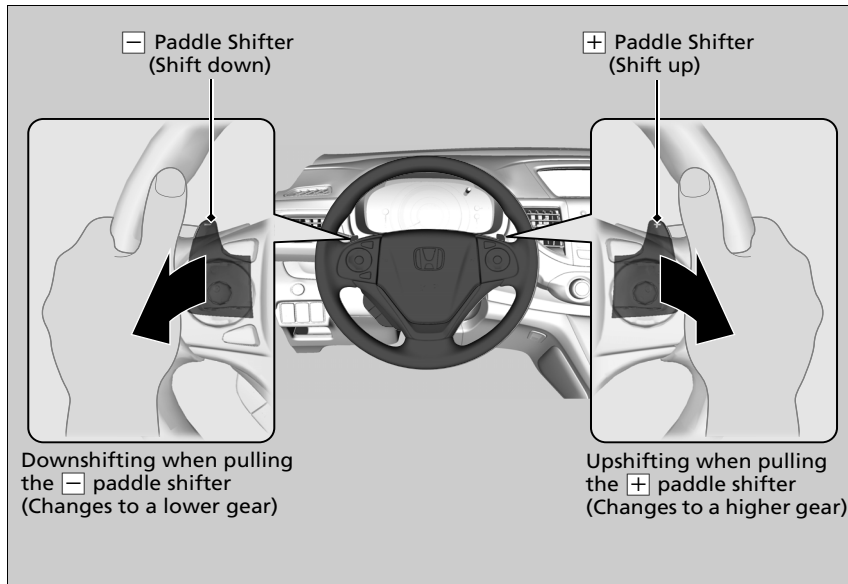

Sequential Mode Operation

Each paddle shift operation makes a single gear change.

To change gears continuously, release the paddle shifter before pulling it again for the next gear.

If the sequential mode gear selection indicator blinks when you try to shift up or down, this means your vehicle speed is not in its allowable gear range. Slightly accelerate to shift up and decelerate to shift down while the indicator is blinking.

Shift Up/Down Indicators

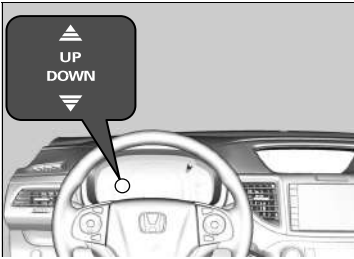

Come on while the vehicle is in the sequential mode to indicate when a gear change is appropriate to maintain the most fuel efficient driving style.

The shift up indicator: Comes on when shifting up is recommended.

The shift down indicator: Comes on when shifting down is recommended.

Shift Up/Down Indicators

⚠ WARNING

The shift indicator is only a guide to help you achieve better fuel economy. Never refer to the Shift Indicators when road and traffic conditions are unsuitable or when it may distract you.

This indicator will not prompt you to downshift to increase engine braking. It is up to you to downshift to increase engine braking when driving downhill.

Always shift down at the appropriate vehicle speed.

When the ECON mode is on, ambient meter colour may change if you do not change gears when a shift indicator illuminates. This can result in a change in fuel economy.

Road and traffic conditions may require you to shift at times other than those indicated.

Manual transmission models

Shifting

Shift Lever Operation

Fully depress the clutch pedal to operate the shift lever and change gears, then slowly release the pedal.

Depress the clutch pedal, and pause for a few seconds before shifting into **R**, or shift into one of the forward gears for a moment. This stops the gears so they do not “grind.”

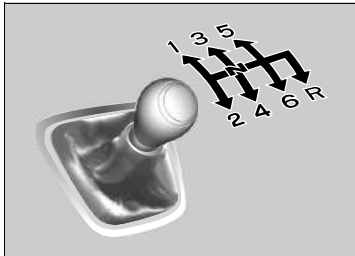

When you are not shifting, do not rest your foot on the clutch pedal. This can cause your clutch to wear out faster.

Shifting

NOTICE

Do not shift to **R** before the vehicle comes to a complete stop.

Shifting to **R** before stopping can damage the transmission.

NOTICE

Before downshifting, make sure the engine will not go into the tachometer’s red zone. Should this occur, it can severely damage your engine.

There is a metallic part on the shift lever. If you leave the vehicle parked outside for a long time on a hot day, be careful before moving the shift lever. Because of heat, the shift lever may be extremely hot. If the outside temperature is low, the shift lever may feel cold.

If you exceed the maximum speed for the gear you are in, the engine speed will enter into the tachometer’s red zone. When this happens, you may experience a slight jolt.

Shift Up/Down Indicators

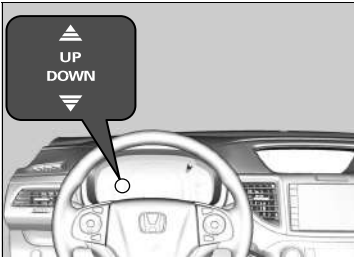

Come on to indicate when a gear change is appropriate to maintain the most fuel efficient driving style.

The shift up indicator: Comes on when shifting up is recommended.

The shift down indicator: Comes on when shifting down is recommended.

Shift Up/Down Indicators

⚠ WARNING

The shift indicator is only a guide to help you achieve better fuel economy. Never refer to the Shift Indicators when road and traffic conditions are unsuitable or when it may distract you.

This indicator will not prompt you to downshift to increase engine braking. It is up to you to downshift to increase engine braking when driving downhill.

Always shift down at the appropriate vehicle speed.

The shift down indicator does not come on when downshifting from **2** to **1**.

When the ECON mode is on, ambient meter colour may change if you do not change gears when a shift indicator illuminates. This can result in a change in fuel economy.

Road and traffic conditions may require you to shift at times other than those indicated.

Continued

Reverse Lockout

The manual transmission has a lockout mechanism that stops you from accidentally shifting into **R** from a forward gear while the vehicle is moving at a certain speed.

If you cannot shift to **R** when the vehicle is stopped, do the following:

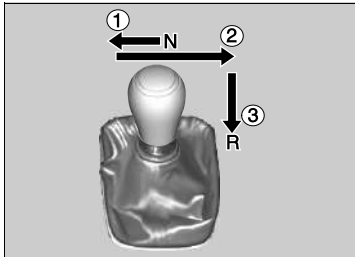

1. Depress the clutch pedal, move the shift lever all the way to the left, and shift to **N**.
2. If you still cannot shift into **R**, apply the parking brake, and turn the ignition switch to ACCESSORY **I** or LOCK **0***1.
3. Depress the clutch pedal and shift into **R**.
4. Keep depressing the clutch pedal and start the engine.

Have the vehicle checked by a dealer if you have to go through this procedure repeatedly.

*1: Models with the keyless access system have an **ENGINE START/STOP** button instead of an ignition switch.

9-speed automatic transmission models

Auto Idle Stop

To help maximize fuel economy, the engine automatically stops when the vehicle comes to a stop, depending on environmental and vehicle operating conditions. The indicator comes on.

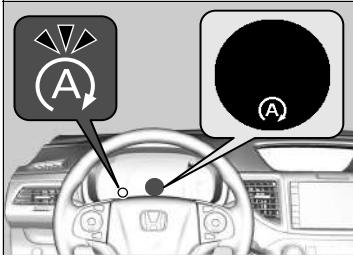

The engine then restarts once the vehicle is about to move again, and the indicator goes off.

A message associated with Auto Idle Stop appears on the multi-information display.

➤ **Indicators** P. 107

➤ **Customized Features** P. 139

If the driver's door is opened while the indicator is on, a buzzer sounds to notify you that the Auto Idle Stop function is in operation.

Auto Idle Stop System ON/OFF

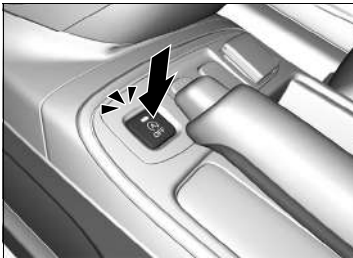

To turn the Auto Idle Stop system off, press this button. The Auto Idle Stop system stops.

▶ Auto Idle Stop system will stop and the indicator will come on.

Auto Idle Stop

The battery installed in this vehicle is specifically designed for a model with Auto Idle Stop. Using a battery other than this specified type may shorten the battery life, and prevent Auto Idle Stop from activating. If you need to replace the battery, make sure to select the specified type. Ask a dealer for more details.

➤ **Specifications** P. 652

The duration of the Auto Idle Stop operation:

- **Increase** in the ECON mode, compared to when the ECON mode is off, with climate control in use.

Auto Idle Stop System ON/OFF



Press the Auto idle stop system **OFF** button to restart the engine from the idling stop.

Continued

■ Auto Idle Stop Activates When:

The vehicle stops with the gear position in **D** and the brake pedal depressed.

■ Auto idle stop does not activate when:

- The driver's seat belt is not fastened.
- The engine coolant temperature is low or high.
- The transmission fluid temperature is low or high.
- The vehicle comes to a stop again before the vehicle speed reaches 5 km/h (3 mph) after the engine starts.
- Stopped on a steep incline.
- The gear position is in a position other than **D**.
- The engine is started with the bonnet open.
 - ▶ Turn off the engine. Close the bonnet before you restart the engine to activate auto idle stop.
-  is ON (indicator on).
- The battery charge is low.
- The internal temperature of the battery is -10°C or less.
- The climate control system is in use, and the outside temperature is below -20°C or over 40°C.
- The climate control system temperature is set to the **Hi** or **Lo**.
-  is ON (indicator on).

⚡ Auto Idle Stop Activates When:

Do not open a bonnet, during idling stop. If the bonnet is opened, the engine will not restart automatically.

In this case, restart the engine with the ignition switch* or the **ENGINE START/STOP** button*.

▶ **Starting the Engine** P. 397, 400

Models with keyless access system

Pressing the **ENGINE START/STOP** button changes the power mode to ACCESSORY even while Auto Idle Stop is in operation. Once in ACCESSORY, the engine no longer restarts automatically. Follow the standard procedure to start the engine.

▶ **Starting the Engine** P. 400

■ Auto idle stop may not activate when:

- The vehicle is stopped by braking suddenly.
- The steering wheel is operated.
- The fan speed is high.
- The vehicle is repeatedly accelerated and decelerated at a low speed.
- The climate control system is in use, and there is a significant difference between the set temperature and the actual interior temperature.
- Humidity in the interior is high.

■ The Engine Automatically Restarts When:

The brake pedal is released.

■ The engine restarts even if the brake pedal is depressed when:

- The Auto Idle Stop **OFF** button is pressed.
- A steering wheel is operated.
- The gear position is change to **[R]** or **[S]**, or when it is change from **[N]** to **[D]**.
- The pressure on the brake pedal is reduced and the vehicle starts moving while stopped on an incline.
- The pressure on the brake pedal is repeatedly applied and released slightly during a stop.
- The battery charge becomes low.
- The accelerator pedal is depressed.
- The driver's seat belt is unlatched.
-  is ON (indicator on).
- The climate control system is in use, and the difference between the set temperature and actual interior temperature becomes significant.
- The climate control system is being used to dehumidify the interior.

⌘ The Engine Automatically Restarts When:

- If you are using an electronic device during Auto Idle Stop, the device may temporarily be turned off when the engine restarts.

Continued

■ Starting Assist Brake Function

Briefly keeps the brake applied after releasing the brake pedal to restart the engine. This can keep your vehicle from unexpectedly moving while on an incline.

Manual transmission models

Auto Idle Stop

To help maximize fuel economy, the engine automatically stops when the vehicle comes to a stop, depending on environmental and vehicle operating conditions. The indicator comes on at this time. The engine then restarts once the vehicle is about to move again when you depress the clutch pedal, and the indicator goes off.

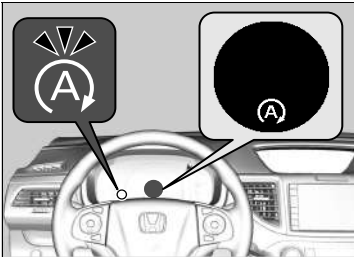

If the driver's door is opened while the indicator comes on, a buzzer sounds to notify you that Auto Idle Stop function is in operation.

A message associated with Auto Idle Stop appears on the multi-information display.

➤ **Indicators** P. 107

➤ **Customized Features** P. 139

Auto Idle Stop System ON/OFF

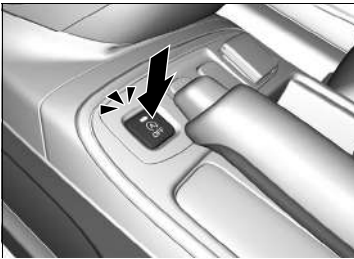

To turn the Auto Idle Stop system off, press this button. The Auto Idle Stop system stops.

▶ Auto Idle Stop system will stop and the indicator will come on.

Auto Idle Stop

The battery installed in this vehicle is specifically designed for a model with Auto Idle Stop. Using a battery other than this specified type may shorten the battery life, and prevent Auto Idle Stop from activating. If you need to replace the battery, make sure to select the specified type. Ask a dealer for more details.

➤ **Specifications** P. 652

If Auto Idle Stop is turned on long enough to lower the battery charge, the engine may not restart automatically. Manually turn off the engine when you leave your vehicle.

The duration of Auto Idle Stop operation:

- **Increases** in the ECON mode, compared to when the ECON mode is off, with climate control in use.

Auto Idle Stop System ON/OFF

Press the Auto idle stop system **OFF** button to restart the engine from the idling stop.

■ Auto Idle Stop Activates When:

After the vehicle moves forward, stopping with the brake, the clutch pedal is fully depressed, the shift lever is in **N**, and release the clutch pedal.

- ▶ To restart the engine automatically, depress the clutch pedal.

■ Auto Idle Stop does not activate when:

- The driver's seat belt is not fastened.
- The engine coolant temperature is low or high.
- The vehicle comes to a stop again before the vehicle speed reaches 3 km/h (2 mph) after the engine starts.
- The shift lever is in any position except **N**.
- The engine is started with the bonnet open.
 - ▶ Turn off the engine. Close the bonnet before you restart the engine to activate auto idle stop.
- The battery charge is low.
- The internal temperature of the battery is -10°C or less.
- The climate control system is in use, and you set the driver side temperature to the lower or upper limit, **Lo** or **Hi** is displayed.
- The climate control system is in use, and the ambient temperature is -20°C or lower, or 40°C or higher.
-  is on (the indicator is on).

■ Auto Idle Stop may not activate when:

- The steering wheel is operated.
- The climate control system is in use, and the fan speed is selected to high.
- The climate control system is in use, and the ambient conditions may be different from the climate control settings you have selected.
- Humidity in the interior is high.

Petrol models

- Altitude is high.

■ The Engine Automatically Restarts When:

The clutch pedal is depressed.

■ The Engine Automatically Restarts When the Shift Lever is in **[N] Even if the clutch pedal is not depressed When:**

- The Auto Idle Stop **OFF** button is pressed.
- The steering wheel is operated.
- Your vehicle is moved.
- The pressure on the brake pedal is repeatedly applied and released slightly during a stop.
- The battery charge becomes low.

☒ The Engine Automatically Restarts When:

If you are using an electronic device during Auto Idle Stop, the device may temporarily be turned off when the engine restarts.

The engine does not restart automatically when:

- The driver's seat belt is unlatched.
Fasten the driver's seat belt to keep the Auto Idle Stop activated.
- The shift lever is moved from **[N]** to any other position.
Shift to **[N]**.

☒ Display Warning and Information Messages P. 108

When the system stops operating, follow the normal procedure to start the engine.

☒ Starting the Engine P. 397, 400

ECON Button

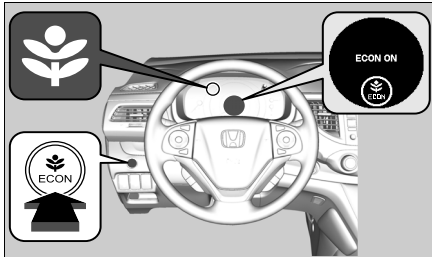

The **ECON** button turns the ECON mode on and off.

Petrol models

The ECON mode helps you to improve your fuel economy by adjusting the performance of the engine, transmission, climate control system and cruise control.

Diesel models

The ECON mode helps you to improve your fuel economy by adjusting the performance of the transmission, climate control system and cruise control.

Cruise Control*

Maintains a constant vehicle speed without having to keep your foot on the accelerator. Use cruise control on motorways or open roads where you can travel at a constant speed with little acceleration or deceleration.

When to use

- Vehicle speed for cruise control: Desired speed in a range from about 30 km/h (18 mph) to about 200 km/h (125 mph)

Always keep sufficient distance between you and the vehicle in front of you.

Automatic transmission models

- Gear positions for cruise control: In **D** or **S**

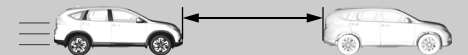

How to use

- Press the **MAIN** button on the steering wheel

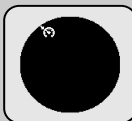
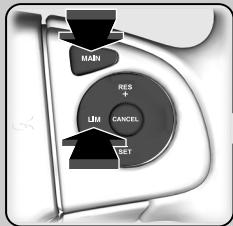

The indicator is on in the instrument panel
Cruise control is ready to use.

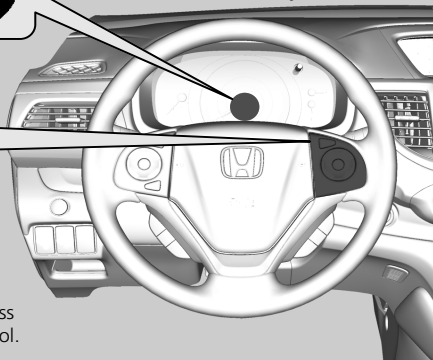

If a different instrument panel is displayed, press the **LIM** button to change it to the cruise control.

» Cruise Control*

⚠ WARNING

Improper use of the cruise control can lead to a crash.

Use the cruise control only when travelling on open motorways in good weather.

It may not be possible to maintain a constant speed when driving uphill or downhill.

Manual transmission models

When the engine speed slow down, try to downshift. You can maintain the set speed if you change gear within five seconds.

When not using cruise control:
Turn off cruise control by pressing the **MAIN** button.

While in the **ECON** mode, it may take more time to accelerate.

You cannot use the cruise control and the adjustable speed limiter at the same time.

* Not available on all models

Continued

■ To Set the Vehicle Speed

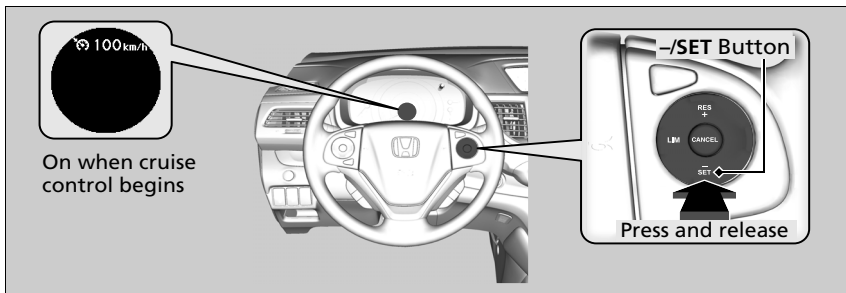

Take your foot off the pedal and press the **-/SET** button when you reach the desired speed.

The moment you release the **-/SET** button, the set speed is fixed, and cruise control begins. The set speed is displayed.

▣ To Set the Vehicle Speed

You can switch the displayed set speed measurements on the multi-information display between km/h and mph.

▣ **Customized Features** P. 133

■ To Adjust the Set Speed

Increase or decrease the set speed using the **RES/+** or **-/SET** buttons on the steering wheel.

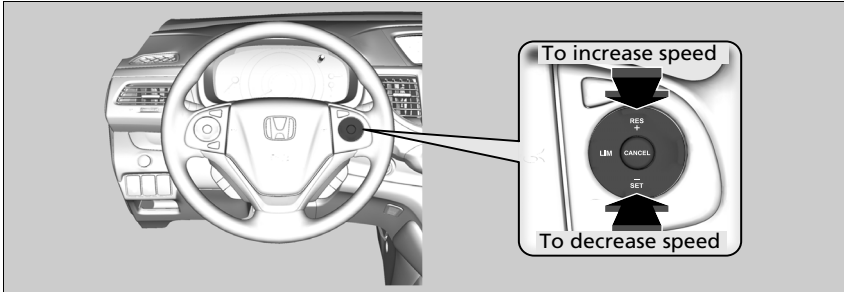

- Each time you press the button, the set speed increases or decreases by 1 km/h or 1 mph accordingly.
- If you keep the button pressed, the set speed increases or decreases in increments of 10 km/h or 10 mph every 0.5 second until system limit is reached.
- The vehicle will accelerate or decelerate until the set speed is reached.

To Cancel

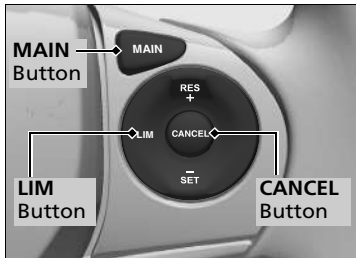

To cancel cruise control, do any of the following:

- Press the **CANCEL** button.
- Press the **MAIN** button.
- Press the **LIM** button.
- Depress the brake pedal.
- Depress the clutch pedal for five seconds or more.

The displayed set speed goes off.

▶▶ To Cancel

Resuming the prior set speed:

After cruise control has been cancelled, you can still resume the prior set speed by pressing the **RES/+** button while driving at a speed of at least 30 km/h (18 mph) or more.

You cannot set or resume in the following situations:

- When vehicle speed is less than 30 km/h (18 mph)
- When the **MAIN** button is turned off

At vehicle speeds of 25 km/h (16mph) or less, cruise control is cancelled automatically.

Adjustable Speed Limiter

This system enables you to set a maximum speed that cannot be exceeded even if you are depressing the accelerator pedal.
The vehicle speed limit can be set from about 30 km/h (18 mph) to about 250 km/h (156 mph).

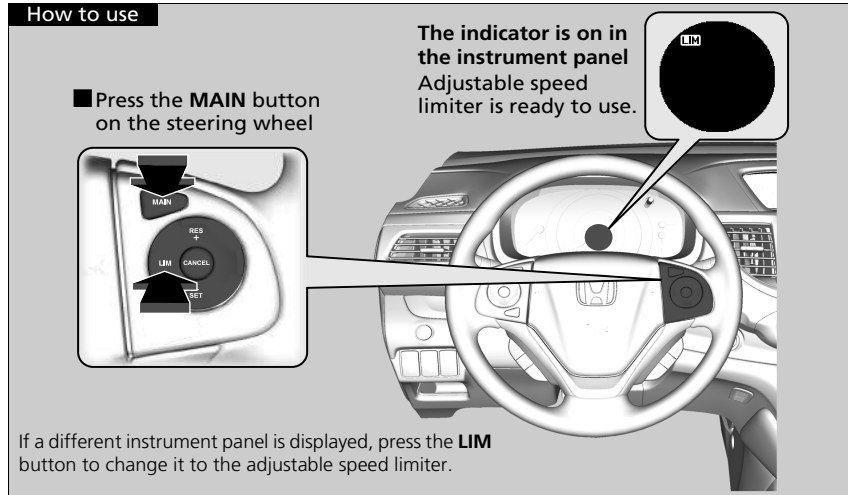

Adjustable Speed Limiter

The adjustable speed limiter may not hold the set speed limit when driving downhill. If this occurs, slow down by depressing the brake pedal.

When not using the adjustable speed limiter:
Turn off the adjustable speed limiter by pressing the **MAIN** button.

You cannot use the adjustable speed limiter and the cruise control/ACC (adaptive cruise control) at the same time.

Manual transmission models

When the engine speed slow down, try to downshift.

Continued

■ To Set the Vehicle Speed

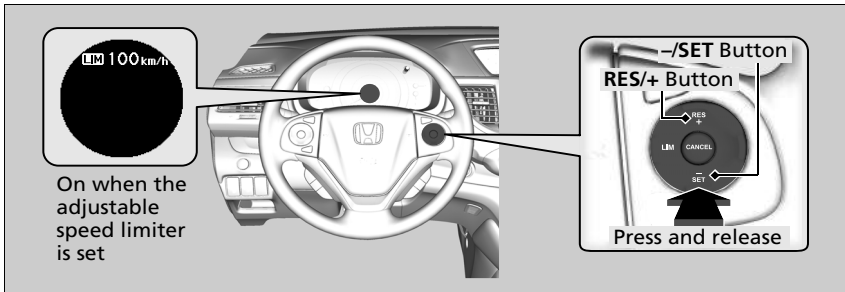

- Take your foot off the pedal and press the **-/SET** button when you reach the desired speed.
The moment you release the **-/SET** button, the set speed is fixed, and the adjustable speed limiter is set. The set speed is displayed.
- You can set the previously set speed limit by pressing the **RES/+** button.

▣ To Set the Vehicle Speed

If you set the speed limit while travelling at less than 30 km/h (18 mph), the speed limit is set to 30 km/h (18 mph).

The beeper sounds and the displayed speed limit blinks if the vehicle speed exceeds the limit by 3 km/h (2 mph) or more on a steep descent.

The adjustable speed limiter is set to the current speed if it is higher than the previously set speed limit when you press the **RES/+** button.

You can switch the displayed set speed measurements on the multi-information display between km/h and mph.

▣ **Customized Features** P. 133

■ To Adjust the Speed Limit

Increase or decrease the speed limit by using the **RES/+** or **-/SET** buttons on the steering wheel.

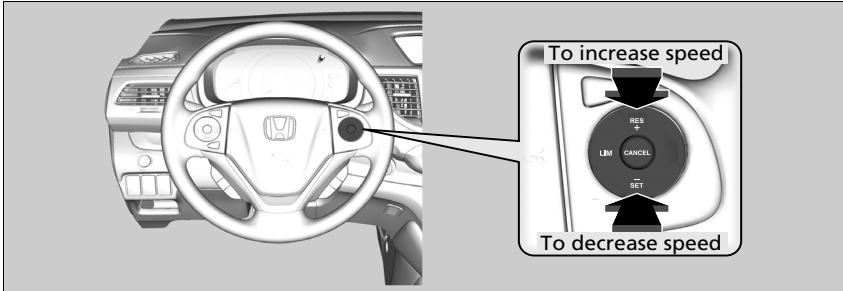

- Each time you press the button, the set speed increases or decreases by 1 km/h or 1 mph accordingly.
- If you keep the button pressed, the set speed increases or decreases in increments of 10 km/h or 10 mph every 0.5 second until system limit is reached.
- The vehicle will accelerate or decelerate until the set speed is reached.

■ Exceeding the Speed Limit Temporarily

The speed limit can be exceeded by depressing the acceleration pedal completely.

- ▶ The displayed limit speed blinks.
- ▶ The beeper sounds once the speed limit has been exceeded.

⊠ Exceeding the Speed Limit Temporarily

The beeper sounds when the vehicle speed goes higher than the set speed limit with the acceleration pedal depressed completely.

The adjustable speed limiter resumes working once the vehicle speed goes lower than the set speed limit.

Continued

■ To Cancel

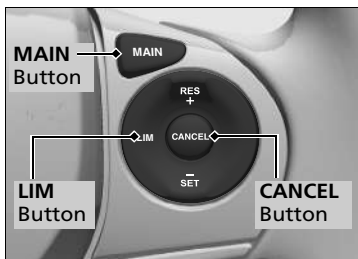

To cancel the adjustable speed limiter, do any of the following:

- Press the **CANCEL** button.
- Press the **MAIN** button.
- Press the **LIM** button.

☒ To Cancel

The adjustable speed limiter changes into cruise control/ACC (adaptive cruise control) if the **LIM** button is pressed.

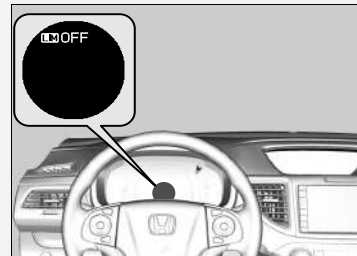

If there is a problem with the system when you are using the adjustable speed limiter, the beeper sounds and the **OFF** comes on. The adjustable speed limiter will be turned off.

Front Sensor Camera*

The camera, used in systems; such as, LKAS, ACC, Forward Collision Warning, Lane Departure Warning, Traffic Sign Recognition System, CMBS and high beam support system, is designed to detect an object that triggers any of the systems to operate their functions.

Camera Location and Handling Tips

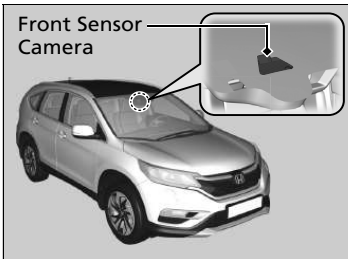

This camera is located behind the rearview mirror.

To help reduce the likelihood that high interior temperatures will cause the camera's sensing system to shut off, when parking, find a shady area or face the front of the vehicle away from the sun. If you use a reflective sun shade, do not allow it to cover the camera housing. Covering the camera can concentrate heat on it.

Front Sensor Camera*

Never apply a film or attach any objects to windscreen, the bonnet, or the front grill that could obstruct the camera's field of vision and cause the system to operate abnormally. Scratches, nicks, and other damage to the windscreen within the camera's field of vision can cause the system to operate abnormally. If this occurs, we recommend that you replace the windscreen with a genuine Honda replacement windscreen. Making even minor repairs within the camera's field of vision or installing an aftermarket replacement windscreen may also cause the system to operate abnormally. After replacing the windscreen, have a dealer recalibrate the camera. Proper calibration of the camera is necessary for the system to operate properly.

Do not place an object on the top of the instrument panel. It may reflect onto the windscreen and prevent the system from detecting lane lines properly.

Front Sensor Camera *

If the  message appears:

- Use the climate control system to cool down the interior and, if necessary, also use demister mode with the air flow directed towards the camera.
- Start driving the vehicle to lower the windscreen temperature, which cools down the area around the camera.

If the  message appears:

- Park your vehicle in a safe place, and clean the windscreen. If the message does not disappear after you have cleaned the windscreen and driven for a while, have your vehicle checked by a dealer.

Adaptive Cruise Control (ACC)*

Helps maintain a constant vehicle speed and a set following distance behind a vehicle detected ahead of yours, without you having to keep your foot on the brake or the accelerator.

When ACC slows your vehicle by applying the brakes, your vehicle's brake lights will illuminate.

When to use

The camera is located behind the rearview mirror.

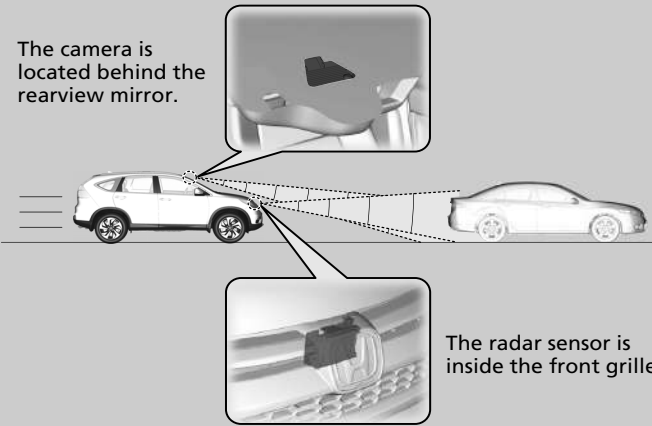

The radar sensor is inside the front grille.

■ Vehicle speed for adaptive cruise control:
Desired speed in a range above roughly 30 km/h (18 mph) ~

Automatic transmission models

■ Gear positions for adaptive cruise control:
In **D** or **S**

Adaptive Cruise Control (ACC)*

⚠ WARNING

Improper use of ACC can lead to a crash.

Use ACC only when travelling on open motorways in good weather.

⚠ WARNING

ACC has limited braking capability. When your vehicle speed drops below 25 km/h (16 mph), ACC will automatically cancel and no longer will apply your vehicle's brakes. Always be prepared to apply the brake pedal when conditions require.

Important Reminder

As with any system, there are limits to ACC. Use the brake pedal whenever necessary, and always keep a safe distance between your vehicle and other vehicles.

* Not available on all models

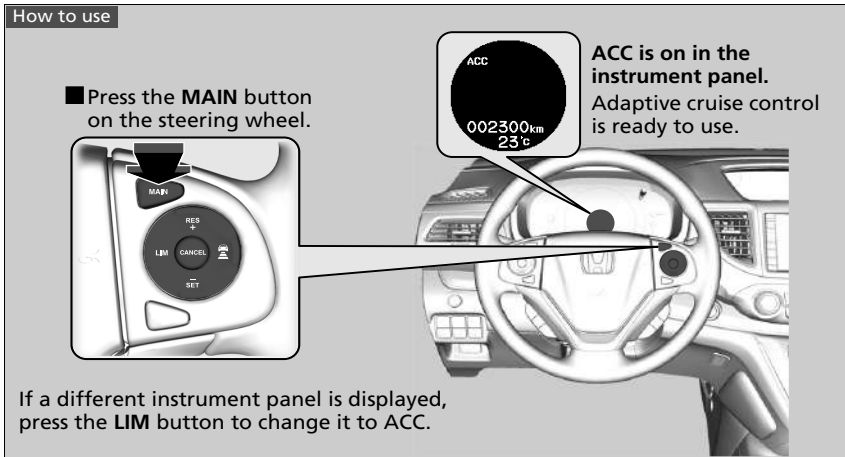

▶ Adaptive Cruise Control (ACC)*

ACC may not work properly under certain conditions.

▶ **ACC Conditions and Limitations** P. 446

When not using adaptive cruise control: Turn off adaptive cruise by pressing the **MAIN** button. This also will turn off the Lane Keeping Assist System (LKAS).

Do not use the ACC under the following conditions.

- On roads with heavy traffic or while driving in continuous stop and go traffic.
- On roads with sharp turns.
- On roads with steep downhill sections, as the set vehicle speed can be exceeded by coasting. In such cases, the ACC will not apply the brakes to maintain the set speed.
- On roads with toll collection facilities or other objects between lanes of traffic, or in parking areas, or facilities with drive through access.

Manual transmission models

When the engine speed slows down, try to downshift. You can maintain the set speed if you change gear within five seconds.

It may take more time to accelerate in ECON mode.

You cannot use cruise control and the adjustable speed limiter at the same time.

You cannot use the ACC and the adjustable speed limiter at the same time.

To Set the Vehicle Speed

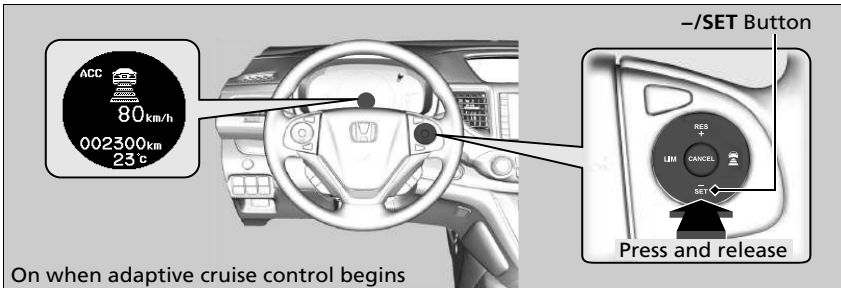

Take your foot off the pedal and press the **-/SET** button when you reach the desired speed.

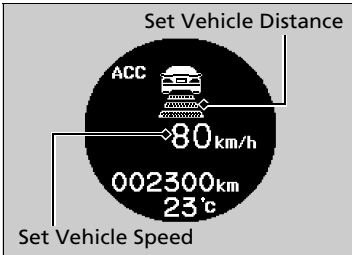

The moment you release the **-/SET** button, the set speed is fixed, and adaptive cruise control begins.

- ▶ A vehicle icon and distance bars appear on the multi-information display.

Adaptive Cruise Control (ACC)*

While in the ECON mode, it may take more time to accelerate.

* Not available on all models

■ When in Operation

■ There is a vehicle ahead

ACC monitors if a vehicle ahead of you enters the ACC range. If a vehicle is detected doing so, the ACC system maintains or decelerates your vehicle's set speed in order to keep the vehicle's set following-distance from the vehicle ahead.

➤ **To Change Vehicle Distance** P. 449

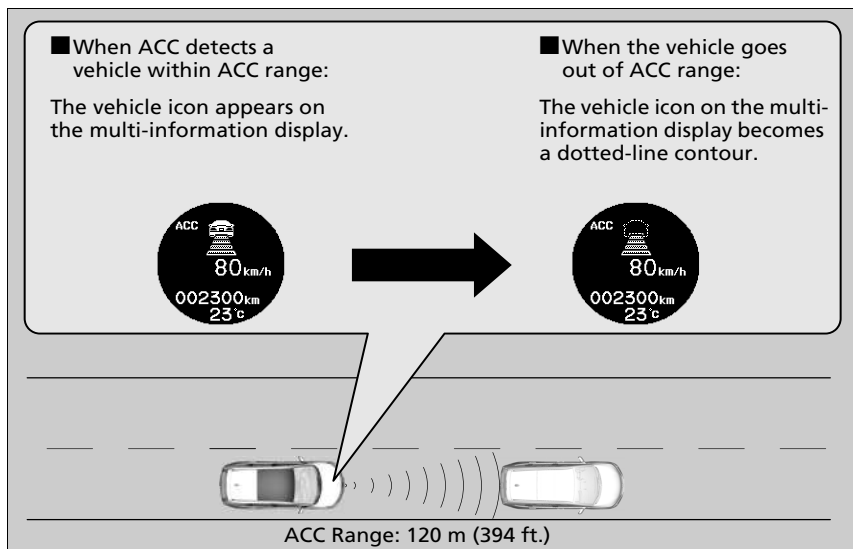

⌘ When in Operation

If the vehicle detected ahead of you slows down abruptly, or if another vehicle is detected cutting in front of you, the beeper sounds and a message appears on the multi-information display to alert you to brake.

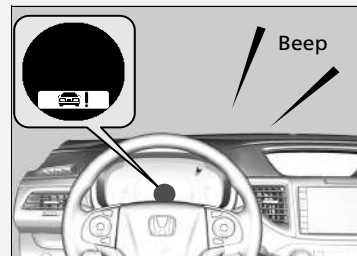

Depress the brake pedal, and keep an appropriate distance from the vehicle ahead.

■ There is no vehicle ahead

Your vehicle cruises at the set speed.

■ A vehicle ahead is within ACC range and going slower than the set speed

Your vehicle slows down, and maintains the same speed as the speed of the vehicle ahead.

■ A vehicle ahead is within ACC range and going at a steady speed

Your vehicle follows the vehicle ahead of it, keeping a constant distance, without going beyond the set speed.

■ A vehicle ahead goes out of range

ACC accelerates your vehicle to the set speed, and then maintains it.

■ When you depress the accelerator pedal

You can temporarily increase the vehicle speed. In this case, there is no audible or visual alerts even if a vehicle is in ACC range.

ACC stays on unless you cancel it. Once you release the accelerator pedal, the system resumes the set speed.

There are times when the vehicle speed will decrease when the accelerator pedal is lightly applied.

☞ When in Operation

Even if the distance between your vehicle and the vehicle detected ahead is short, ACC may start accelerating your vehicle under the following circumstances:

- The vehicle detected ahead of you is going at almost the same speed as, or faster than your vehicle.
- A vehicle that cuts in front of you is going faster than your vehicle, gradually distancing itself from you.

You can also set the system to beep when a vehicle detected in front of you comes in and goes out of the ACC detecting range. Change the **ACC VEHICLE AHEAD DETECTED BEEP** setting.

☞ **Customized Features** P. 133

Limitations

You may need to use the brake to maintain a safe distance when using ACC.

Additionally, ACC may not work properly under certain conditions.

☞ **ACC Conditions and Limitations** P. 446

■ ACC Conditions and Limitations

The system may automatically shut off and the **ACC** indicator will come on under certain conditions. Some examples of these conditions are listed below. Other conditions may reduce some of the ACC functions.

➤ **Front Sensor Camera*** P. 439

■ Environmental conditions

Driving in bad weather (rain, fog, snow, etc.).

■ Roadway conditions

Driving on a snowy or wet roadway (obscured lane marking, vehicle tracks, reflected lights, road spray, high contrast).

■ Vehicle conditions

- The outside of the windscreen is blocked by dirt, mud, leaves, wet snow, etc.
- An abnormal tyre or wheel condition (wrong sized, varied size or construction, improperly inflated tyre, etc.).
- The camera temperature gets too hot.
- The parking brake is applied.
- When the front grille is dirty.
- When the front of the vehicle tilts up due to heavy items in the luggage area or rear seats.
- When tyre chains are installed.

➤ ACC Conditions and Limitations

The radar sensor for ACC is shared with the Collision Mitigation Braking System (CMBS).

➤ **Collision Mitigation Braking System (CMBS)*** P. 493

You can read about handling information for the camera equipped with this system.

➤ **Front Sensor Camera*** P. 439

■ Detection limitations

- A vehicle or pedestrian suddenly crosses in front of you.
- The distance between your vehicle and the vehicle or pedestrian ahead of you is too short.
- A vehicle cuts in front of you at a slow speed, and it brakes suddenly.
- When you accelerate rapidly and approach the vehicle or pedestrian ahead of you at high speed.
- The vehicle ahead of you is a motorcycle, bicycle, mobility scooter, or other small vehicle.
- When there are animals in front of your vehicle.
- When you drive on a curved or winding or undulating road that makes it difficult for the sensor to properly detect a vehicle or a pedestrian in front of you.
- The speed difference between your vehicle and a vehicle in front of you is significantly large.
- An oncoming vehicle suddenly comes in front of you.
- Your vehicle abruptly crosses over in front of an oncoming vehicle.
- When driving through a narrow iron bridge.
- When the vehicle ahead of you brakes suddenly.
- When the vehicle ahead of you has a unique shape.
- When your vehicle or the vehicle ahead of you is driving on one edge of the lane.

■ To Adjust the Vehicle Speed

Increase or decrease the vehicle speed using the **RES/+** or **-/SET** buttons on the steering wheel.

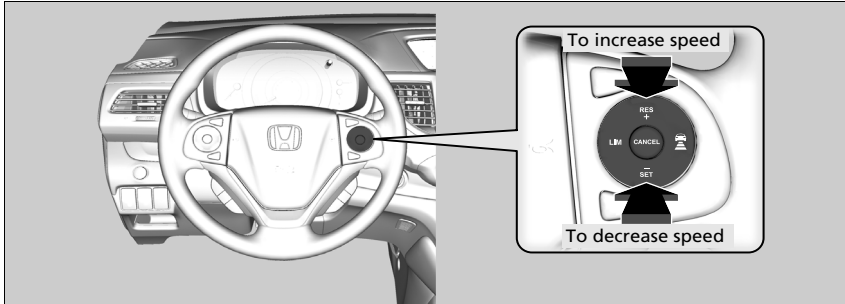



- Each time you press the button, the vehicle speed is increased or decreased by about 1 km/h (1 mph).
- If you keep the button pressed, the vehicle speed increases or decreases by about 10 km/h (10 mph).

☒ To Adjust the Vehicle Speed

If a vehicle detected ahead is going at a speed slower than your increased set speed, ACC may not accelerate your vehicle. This is to maintain the set following distance between your vehicle and the vehicle ahead.

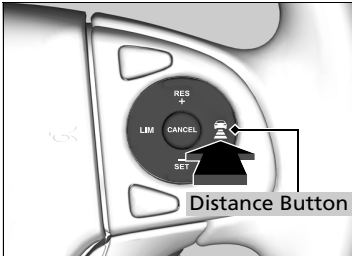
To Change Vehicle Distance



Press the  (distance) button to change ACC range.

Each time you press the button, the following distance (the distance behind a vehicle detected ahead of you) setting cycles through extra long, long, middle, and short following distances.





Determine the most appropriate following distance setting based on your specific driving conditions. Be sure to adhere to any following distance requirements set by local regulation.

To Change Vehicle Distance

The driver must in all circumstances preserve a sufficient braking distance from the vehicle which precedes it and be aware that minimum distances or times of spacing can be provided by the provisions of the Motorway Code locally applicable and that it is the driver's responsibility to respect those laws.

Continued

The higher your vehicle speed is, the longer the short, middle, long or extra long following-distance becomes. See the following examples for your reference.

Following-distance	When the vehicle speed is:	
	80 km/h (50 mph)	104 km/h (65 mph)
 Short	26 metres 84 feet 1.1 sec	31 metres 102 feet 1.1 sec
 Middle	34 metres 111 feet 1.5 sec	43 metres 139 feet 1.5 sec
 Long	48 metres 155 feet 2.1 sec	62 metres 202 feet 2.1 sec
 Extra Long	66 metres 215 feet 3.0 sec	87 metres 285 feet 3.0 sec

To Cancel

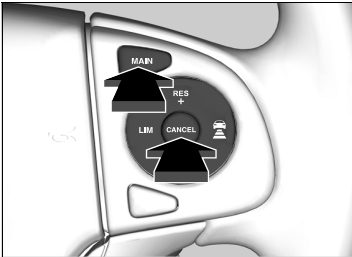

To cancel adaptive cruise control, do any of the following:

- Press the **CANCEL** button.
- Press the **MAIN** button.
- Press the **LIM** button.
- Depress the brake pedal.
- Depress the clutch pedal for five seconds or more.

To Cancel

Resuming the prior set speed: After you have cancelled adaptive cruise control, you can resume the prior set speed while it is still displayed. Press the **RES/+** button when driving at a speed of at least 30 km/h (18 mph) or more.

You cannot set or resume when vehicle speed is less than 30 km/h (18 mph).

The set speed cannot be set or resumed when ACC has been turned off using the **MAIN** button. Press the **MAIN** button to activate the system, then set the desired speed.

Continued

■ Automatic cancellation

The beeper sounds and a message appears on the multi-information display when ACC is automatically cancelled. Any of these conditions may cause the ACC cancellation:

- Your vehicle speed slows down to 25 km/h (16 mph) and below.
- Bad weather (rain, fog, snow, etc.)
- When the radar sensor in the front grille gets dirty.
- The vehicle ahead of you cannot be detected.
- An abnormal tyre condition is detected, or the tyres are skidding.
- Driving on a mountainous road, or driving off road for extended periods.
- Abrupt steering wheel movement.
- When the ABS or VSA is activated.
- When the ABS or VSA system indicator comes on.
- When you manually apply the parking brake.
- When the detected vehicle within the ACC range is too close to your vehicle.
- The camera behind the rearview mirror, or the area around the camera, including the windscreen, gets dirty.

Manual transmission models

- Ignoring shift down indication shown in the tachometer display will cancel the ACC after about 10 seconds.
- The engine speed goes into the tachometer's red zone.
- The engine speed goes to below 1,000 rpm.
- You shift into neutral temporarily when shifting into a higher or lower gear.

Automatic cancellation

OFF comes on for about three seconds when ACC has been automatically cancelled.

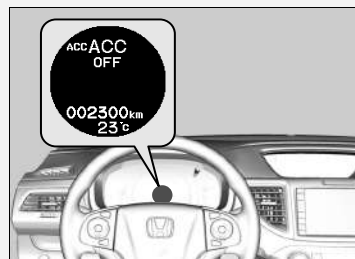

Even though adaptive cruise control has been automatically cancelled, you can still resume the prior set speed. Wait until the condition that caused ACC to cancel improves, then press the **RES/+** button.

■ Intelligent Adaptive Cruise Control Function

Provides an early prediction for a cut-in situation. The system detects that a vehicle running in the adjacent slower lane has an intention to cut in front of you and adjusts the speed of your vehicle in advance while ACC is activated.

■ How the system works

The radar sensor inside the front grille detects vehicles ahead of you including those in the adjacent lane, and the camera behind the rearview mirror detects the lane markings.

This system improves ACC's following/tracking property; it adjusts your vehicle speed in advance predicting a situation that a vehicle running in the adjacent slower lane catches up with a slower vehicle ahead of it and changes the lane to cut in front of you early.

When such a cut-in situation is predicted, your vehicle speed decreases a little. When detected, your vehicle speed decreases according to the vehicle cutting in front of you.

As the speed is adjusted by the system, the cut in vehicle icon appears on the multi-information display to indicate that the system is activated.

Left-hand drive type is shown.

■ How the system activates

When a vehicle cuts in front of you is going faster than the vehicle ahead of it, and your vehicle is going faster than the cut-in vehicle (i.e., when you need to slow down), ACC predicts the cutting-in and adjust your vehicle speed.

The system activates when all the following conditions are met:

- When ACC is activated.
- When you are driving on a multi-lane road.
- When your vehicle speed is between about 80 km/h (50 mph) and about 180 km/h (112 mph).
- The vehicle is on a straight or slightly curved road.
- The turn signals are off.
- The brake pedal is not depressed.
- When a vehicle cuts in from a slower lane.

■ Intelligent adaptive cruise control on and off

You can turn the system on and off using the multi-information display.

➔ **Customized Features** P. 133

☒ Intelligent Adaptive Cruise Control Function

When traffic changes from right hand side to left hand side, driving on a road where there is oncoming traffic for some distance automatically switches the lane to be detected from right to left.

Intelligent adaptive cruise control may not activate under the following conditions:

- When the speed difference between the cut-in vehicle and the vehicle ahead of it in the adjacent lane*1 is small
- When the speed difference between the cut-in vehicle and your vehicle is small (i.e., when speed adjustment is not required)
- When a vehicle simply cuts in in front of your vehicle with no vehicle ahead in the adjacent lane*1
- When a vehicle cuts in from a faster lane*1

*1: Refers to a right hand lane for right hand traffic, left hand lane for left hand traffic.

Forward Collision Warning*

Alerts you when it detects the possibility of your vehicle colliding with the vehicle in front of yours.

If the system determines a collision is possible, it gives both visual and audible alerts.

- ▶ Take appropriate action to prevent a collision (apply the brakes, change lanes, etc.).

■ How the system works

The system may give warnings of potential collisions when your vehicle speed is above 15 km/h (9 mph).

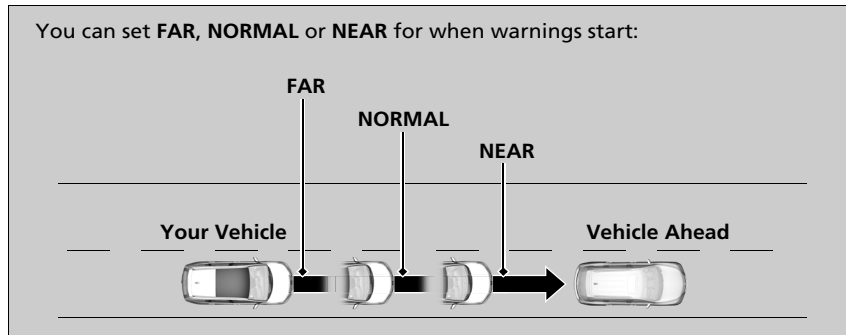

* Not available on all models

Continued

Forward Collision Warning*

Important Safety Reminder

Forward Collision Warning cannot detect all objects ahead and may not detect a given object; accuracy of the system will vary based on weather, speed and other factors. Forward Collision Warning does not include a braking function. It is always your responsibility to safely operate the vehicle and avoid collisions.

You can change the Forward Collision Warning Distance setting or turn the system on and off.

▶ **Customized Features** P. 133

The camera is shared with Lane Departure Warning, Traffic Sign Recognition System and High beam Support System.

For the system's proper operation:

- Do not impact the camera or the area around the camera when you clean the windscreen.
- Keep the upper windscreen clean. Wipe away any debris including ice and frost.

Consult a dealer in the following cases.

- The camera or the area around the camera is severely impacted.
- The area around the windscreen needs repair.

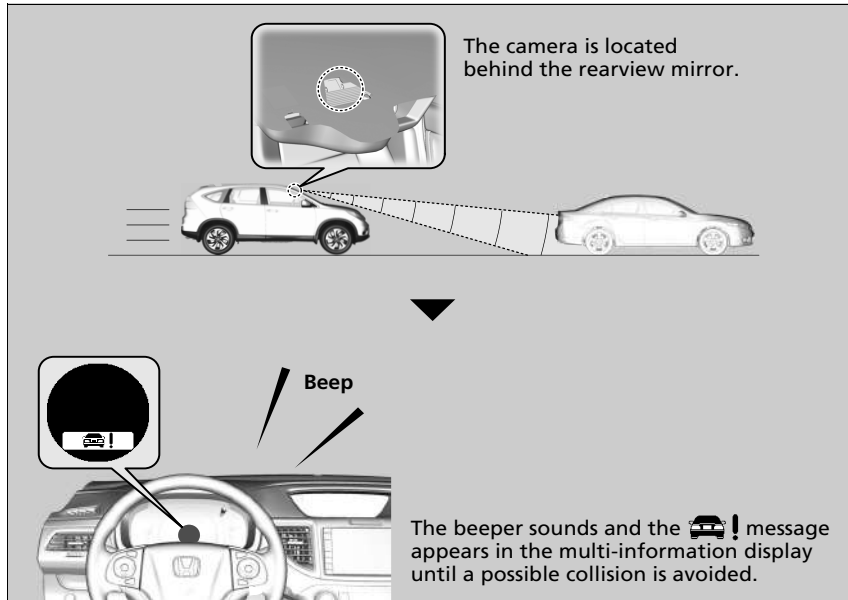

⊠ Forward Collision Warning*

Never apply a film or attach any objects to the windshield that could obstruct the Forward Collision Warning camera's field of vision. Scratches, nicks, and other damage to the windshield within the Forward Collision Warning camera's field of vision can cause the system to operate abnormally. If this occurs, we recommend that you replace the windshield with a genuine Honda replacement windshield. Making even minor repairs within the camera's field of vision or installing an aftermarket replacement windshield may also cause the system to operate abnormally. After replacing the windshield, have a dealer recalibrate the camera. Proper calibration of the Forward Collision Warning camera is necessary for the system to operate properly.

■ Automatic shutoff

Forward Collision Warning may automatically shut itself off and the  indicator comes and stays on when:

- The temperature inside the system is high.
- The windshield is blocked by dirt, mud, leaves, wet snow, etc.

Once the conditions that caused Forward Collision Warning to shut off improve or are addressed (e.g., cleaning), the system comes back on.

☒ Automatic shutoff

To help reduce the likelihood that high interior temperatures will cause the camera system to shut off, when parking, find a shady area or face the front of the vehicle away from the sun.

If you use a reflective sun shade, do not allow it to cover the camera housing. Covering the camera can concentrate heat on the camera.

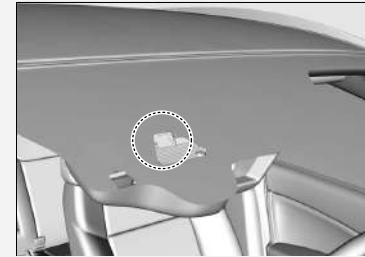

If the  message appears:

- Use the climate control system to cool down the interior and, if necessary, the demister mode when windows are fogged.
- Start driving the vehicle to lower the windshield temperature, which cools down the area around the Forward Collision Warning camera.

If the  message appears:

Park your vehicle in a safe place. Wipe away debris blocking the windshield, then start driving again. If the message remains on even after driving for a while with the clean windshield, have your vehicle checked by a dealer.

Continued

■ Forward Collision Warning Limitations

Forward Collision Warning may not activate or may not detect a vehicle in front of your vehicle, and may activate even when you are aware of a vehicle ahead of you, or when there is no vehicle ahead, under the following conditions.

Condition

- The distance between your vehicle and the vehicle ahead of you is too short.
- A vehicle cuts in front of you at a slow speed, and it brakes suddenly.
- A vehicle suddenly crosses in front of you.
- When either your vehicle or the vehicle ahead of you accelerates rapidly.
- The vehicle ahead of you is a motorcycle, a small vehicle, or a unique vehicle such as a tractor.
- When you drive off-road or on a mountain road, or curved and winding road for an extended period that makes it difficult for the camera to properly detect a vehicle in front of you.
- When there are pedestrians or animals in front of your vehicle.
- When you drive in bad weather (rain, fog, etc.).
- A heavy load in the rear or modifications to the suspension tilts your vehicle.
- An abnormal tyre condition is detected (wrong tyre size, flat tyre, etc.).
- When the windscreen is blocked by dirt, mud, leaves, wet snow, etc.
- When the temperature inside the system is high.
- A sudden change between light and dark such as an entrance or exit of a tunnel.
- You drive into the sunlight (e.g., at dawn or dusk).
- When the windscreen is dirty or cloudy.
- When streetlights are perceived as the taillight of a vehicle in front of yours.
- When driving at night, the vehicle ahead of you is running with either taillight bulb burned out.
- When you drive in the shadows of trees, buildings, etc.
- When your vehicle is towing a trailer.

Lane Departure Warning*

Alerts you when the system detects a possibility of your vehicle unintentionally crossing over left or right side lane markings.

How the System Works

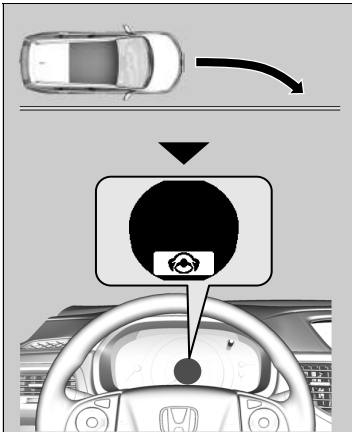

The front camera behind the rearview mirror monitors left and right lane marking.

If your vehicle is getting too close to detected left or right side lane markings without a turn signal activated, Lane Departure Warning will give audible and visual alerts.

The beeper sounds and the  message appears on the multi-information display, letting you know that you need to take appropriate action.

How the System Activates

The system begins to search for lane markings when all the following conditions are met:

- The vehicle is travelling above about 72 km/h (45 mph).
- The vehicle is on a straight or slightly curved road.
- The turn signals are off.
- The brake pedal is not depressed.

* Not available on all models

Continued

☒ Lane Departure Warning*

Important Safety Reminder

Like all assistance systems, Lane Departure Warning has limitations.

Over-reliance on Lane Departure Warning may result in a collision. It is always your responsibility to keep the vehicle within your driving lane.

Lane Departure Warning only alerts you when lane drift is detected without a turn signal in use. Lane Departure Warning may not detect all lane markings or lane departures; accuracy will vary based on weather, speed and lane marker condition. It is always your responsibility to safely operate the vehicle and avoid collisions.

You can read about handling information for the camera equipped with this system.

☒ **Front Sensor Camera*** P. 439

The Lane Departure Warning may not work properly or may work improperly under the certain conditions:

☒ **Lane Departure Warning Conditions and Limitations** P. 461

☒ How the System Activates

Lane Departure Warning may automatically shut off and the  indicator comes and stays on.

☒ **Indicators** P. 84

■ Lane Departure Warning On and Off

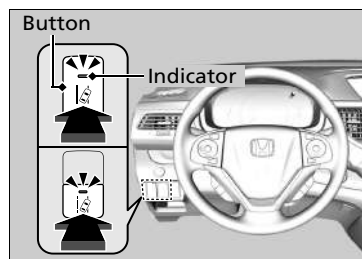

Press the Lane Departure Warning button to turn the system on and off.

- ▶ The indicator in the button comes on when the system is on.

■ Lane Departure Warning Conditions and Limitations

The system may not properly detect lane markings and the position of your vehicle under certain conditions. Some examples of these conditions are listed below.

■ Environmental conditions

- Driving in bad weather (rain, fog, snow, etc.).
- Sudden changes between light and dark, such as an entrance or exit of a tunnel.
- There is little contrast between lane lines and the roadway surface.
- Driving into low sunlight (e.g., at dawn or dusk).
- Strong light is reflected onto the roadway.
- Driving in the shadows of trees, buildings, etc.
- Shadows of adjacent objects are parallel to lane markings.
- Roadway objects or structures are misinterpreted as lane markers.
- Reflections on the interior of the front windshield.

■ Roadway conditions

- Driving on a snowy or wet roadway (obscured lane marking, vehicle tracks, reflected lights, road spray, high contrast).
- Driving on a road with temporary lane markings.
- Faint, multiple, or varied lane markings are visible on the roadway due to road repairs or old lane markings.
- The roadway has merging, split, or crossing lines (e.g., such as at an intersection or crosswalk).
- The lane markings are extremely narrow, wide, or changing.
- The vehicle in front of you is driving near the lane lines.
- The road is hilly or the vehicle is approaching the crest of a hill.
- Driving on rough or unpaved roads, or over bumpy surfaces.
- When objects on the road (curb, guard rail, pylons, etc.) are recognised as white lines (or yellow lines).
- When driving on roads with double lines.

■ Vehicle conditions

- Headlight lenses are dirty or the headlights are not properly adjusted.
- The outside of the windscreen is streaked or blocked by dirt, mud, leaves, wet snow, etc.
- The inside of the windscreen is fogged.
- The camera temperature gets too hot.
- An abnormal tyre or wheel condition (wrong sized, varied size or construction, improperly inflated, compact spare tyre*, etc.).
- The vehicle is tilted due to a heavy load or suspension modifications.
- When tyre chains are installed.

Traffic Sign Recognition System *

Reminds you of road sign information, such as the current speed limit and that overtaking is prohibited, your vehicle has just passed through, showing it on the i-multi-information display.

How the System Works

When the camera located behind the rearview mirror captures traffic signs while driving, the system displays the ones that are recognised as designated for your vehicle. The sign icon will be displayed for a while, then until the vehicle reaches a predetermined time and distance.

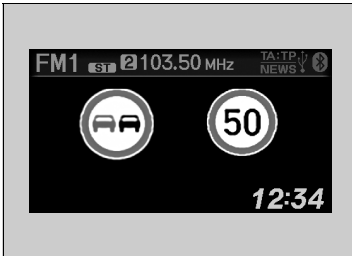

The sign icon also may switch to another one, or disappear when:

- The end of speed limit or other designated limit is detected.
- You make a turn with a turn signal to change direction at an intersection.

Traffic Sign Recognition System *

The system is designed to detect signs that follow the Vienna Convention standards. Not all signs may be displayed, but any signs posted on roadsides should not be ignored. The system does not work on the designated traffic signs of all the countries you travel, nor in all situations.

The Traffic Sign Recognition System is designed to merely provide driving assistance. The driver must still be aware of the road conditions and comply with all road regulations.

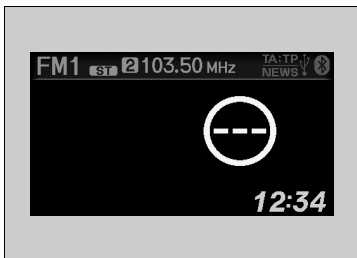

Never apply a film or attach any objects to the windshield that could obstruct the camera's field of vision and cause the system to operate abnormally. Scratches, nicks, and other damage to the windshield within the camera's field of vision can cause the system to operate abnormally. If this occurs, we recommend that you replace the windshield with a genuine Honda replacement windshield. Making even minor repairs within the camera's field of vision or installing an aftermarket replacement windshield may also cause the system to operate abnormally. After replacing the windshield, have a dealer recalibrate the camera. Proper calibration of the camera is necessary for the system to operate properly.

While driving, in addition to when there is no detected sign, you may also see the below screen when.





▶▶ Traffic Sign Recognition System*

To help reduce the likelihood that high interior temperatures will cause the camera's sensing system to shut off, when parking, find a shady area or face the front of the vehicle away from the sun. If you use a reflective sun shade, do not allow it to cover the camera housing. Covering the camera can concentrate heat on it.

If  appears, the Traffic Sign Recognition System does not work, and  will be displayed.

- Use the climate control system to cool down the interior and, if necessary, also use demister mode with the air flow directed towards the camera.
- Start driving the vehicle to lower the windscreen temperature, which cools down the area around the camera.

If  appears, the Traffic Sign Recognition System does not work, and  will be displayed.

- Park your vehicle in a safe place, and clean the windscreen. If the message does not disappear after you have cleaned the windscreen and driven for a while, have your vehicle checked by a dealer.

Traffic Sign Recognition System Conditions and Limitations

The Traffic Sign Recognition system may not be able to recognize the traffic sign in the following cases.

■ Vehicle conditions

- Headlight lenses are dirty or the headlights are not properly adjusted.
- The outside of the windscreen is blocked by dirt, mud, leaves, wet snow, etc.
- The inside of the windscreen is fogged.
- There are portions remaining to be wiped.
- An abnormal tyre or wheel condition (wrong sized, varied size or construction, improperly inflated, compact spare tyre*, etc.).
- The vehicle is tilted due to a heavy load or suspension modifications.

■ Environmental conditions

- Driving into low sunlight (e.g., at dawn or dusk).
- Strong light is reflected onto the roadway.
- Sudden changes between light and dark, such as an entrance or exit of a tunnel.
- When you drive in the shadows of trees, buildings, etc.
- Driving at night, in dark areas such as long tunnels.
- Driving in bad weather (rain, fog, snow, etc.).
- A vehicle in front of you is travelling flying up spray or snow.

☒ Traffic Sign Recognition System Conditions and Limitations

When the Traffic Sign Recognition System malfunctions,  appears on the i-multi-information display. If this message does not disappear, have your vehicle checked by a dealer.



* Not available on all models

■ **The position or the condition of the traffic sign**

- A sign is hard to be found since it is in a complicated area.
- A sign is located far away from your vehicle.
- A sign is located where the beam of the headlight is hard to reach.
- A sign is on a corner or bend in the road.
- Faded or bent signs.
- Rotated or damaged signs.
- A sign is covered with mud, snow, or frost.
- A part of the sign is hidden by the trees, or the sign itself is hidden by a vehicle and others.
- Light (a streetlight) or a shadow is reflected on the surface of the sign.
- A sign is too bright or too dark (an electric sign).
- A sign of a small size.

■ **Other conditions**

- When you are driving at a high speed.

The Traffic Sign Recognition System may not operate correctly, such as displaying a sign that does not follow the actual regulation for the roadway or does not exist at all in the following cases.

- ▶ Regarding the speed limit sign, it may display higher or lower speed than the actual speed limit.
- There is a supplementary sign with further information such as weather, time, vehicle type, etc.
- Figures on the sign are hard to read (electric sign, numbers on the sign are blurred).
- A sign is in the vicinity of the lane you are driving even though it is not for the lane (speed limit sign situated at the junction between the side road and the main road, etc.).
- There are things that look similar to the colour or shape of the recognition object (similar sign, electric sign, signboard, structure, etc.).
- A lorry and others stuck with the sticker of the speed limit sign on the back are travelling in front of you.

■ Signs Displayed on the i-Multi-Information Display

Two traffic signs can be simultaneously displayed next to each other when detected. The speed limit sign icon is displayed on the right half of the screen. The overtaking prohibition sign icon appears on the left. Any additional sign that indicates speed limit based on weather (rain, snow, etc.) or specific period of time can appear on either side.

■ When main mode is selected



Overtaking Prohibition Sign*1 Speed Limit Sign

Additional Speed Limit Sign Based on Conditions*2 Speed Limit Sign

■ When main mode is not selected



Overtaking Prohibition Sign*1

Speed Limit Sign

Depending on situation, *1 can be replaced with *2, or *2 can appear on the right side.

■ **Selecting to display traffic signs when main mode is off**

You can continue displaying reduced-size traffic sign icon on the i-multi-information display even while the main mode is not selected.

➤ **Customized Features** P. 145

Lane Keeping Assist System (LKAS)*

Provides steering input to help to keep the vehicle in the middle of a detected lane and provides audible and visual alerts if the vehicle is detected drifting out of its lane.

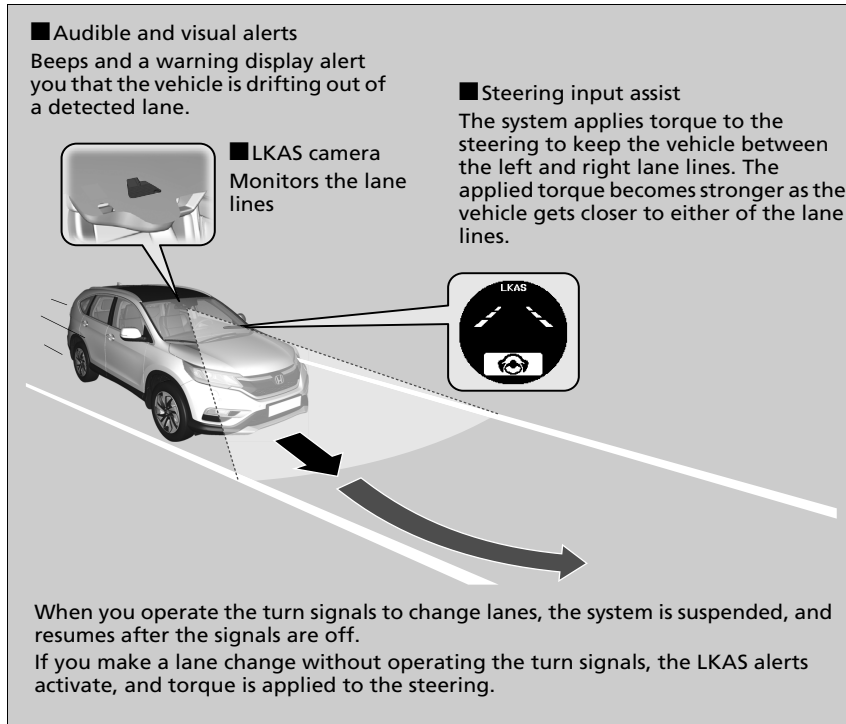

▶ Lane Keeping Assist System (LKAS)*

Important Safety Reminders

The LKAS is for your convenience only. It is not a substitute for your vehicle control. The system does not work if you take your hands off the steering wheel or fail to steer the vehicle.

▶ Display Warning and Information Messages P. 108

Do not place objects on the instrument panel. Objects may reflect on the front windshield and prevent correct detection of the traffic lanes.

LKAS only alerts you when lane drift is detected without a turn signal in use. LKAS may not detect all lane markings or lane departures; accuracy will vary based on weather, speed, and lane marker condition. It is always your responsibility to safely operate the vehicle and avoid collisions.

The LKAS is convenient when it is used on motorways.

LKAS may not work properly under certain conditions.

▶ LKAS Conditions and Limitations P. 476

LKAS may not function as designed on while driving in frequent stop and go traffic, or on roads with sharp curves.

You can read about handling information for the camera equipped with this system.

▶ Front Sensor Camera* P. 439

■ Lane Keep Support Function

Provides assistance to keep the vehicle in the centre of the lane, when the vehicle nears a white or yellow line, steering force of the electric power steering will become stronger.

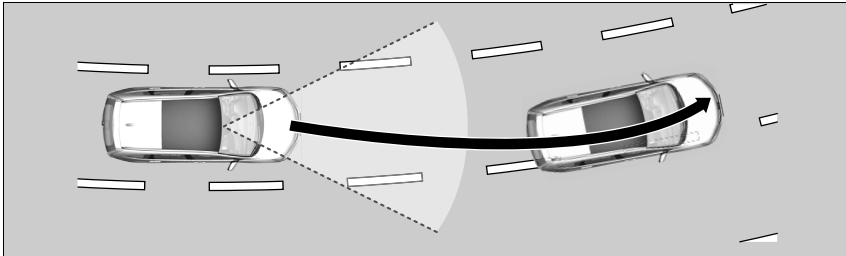

■ Lane Departure Warning Function

When the vehicle enters the warning area, LKAS alerts you with slight steering wheel vibration as well a warning display.

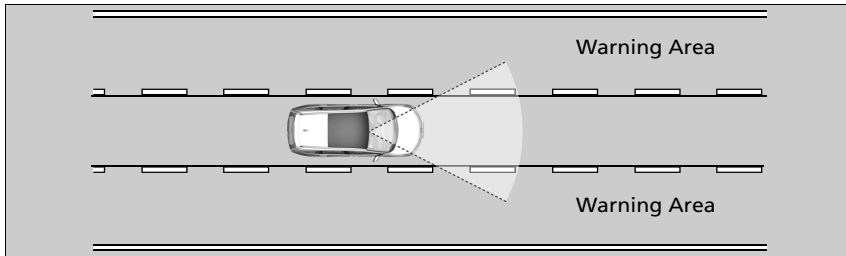

▣ Lane Keeping Assist System (LKAS)*

The LKAS may not function as designed on while driving in frequent stop and go traffic, or on roads with sharp curves.

When it fails to detect lanes, the system will temporarily be cancelled. When lane is detected, system will recover automatically.

* Not available on all models

Continued

■ When the System can be Used

The system can be used when the following conditions are met.

- The lane you are driving has detectable lane markers on both sides, and your vehicle is in the centre of the lane.
- The vehicle speed is between 72 – 180 km/h (45 – 112 mph).
- You are driving on a straight or slightly curved road.
- The turn signals are off.
- The brake pedal is not depressed.
- The wiper switch isn't in the **LO** or **HI** position.

■ How to activate the system

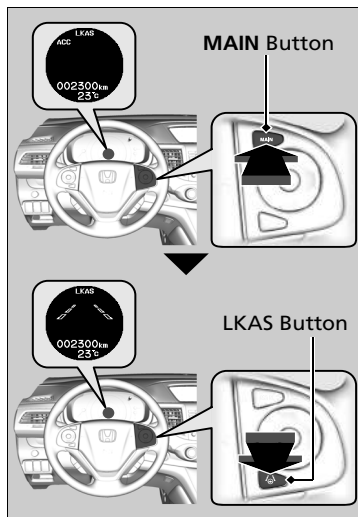

1. Press the **MAIN** button.

- ▶ The LKAS is on in the multi-information display.
The system is ready to use.

2. Press the LKAS button.

- ▶ Lane outlines appear on the multi-information display.
The system is activated.

☒ Lane Keeping Assist System (LKAS)*

You can read about handling information for the camera equipped with this system.

☒ **Front Sensor Camera*** P. 439

If the vehicle drifts toward either left or right lane line due to the system applying torque, turn off the LKAS and have your vehicle checked by a dealer.

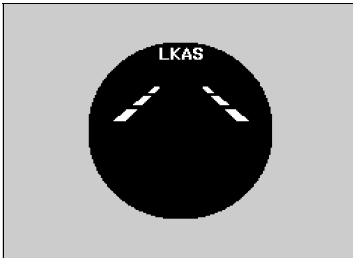

3. Keep your vehicle near the centre of the lane while driving.
 - ▶ The dotted outer lines change to solid ones once the system starts operating after detecting the left and right lane markings.

■ To Cancel

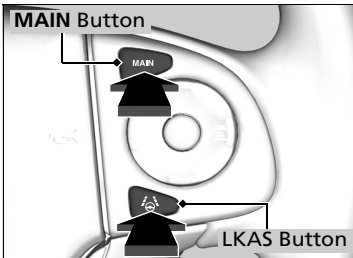

To cancel the LKAS:
Press the **MAIN** or LKAS button.

The LKAS is turned off every time you stop the engine, even if you turned it on the last time you drove the vehicle.

▣ When the System can be Used

The LKAS temporarily deactivates when it fails to detect lane lines. When the system detects the lines again, it comes back on automatically.

▣ To Cancel

Pressing the **MAIN** button also turns ACC on and off.

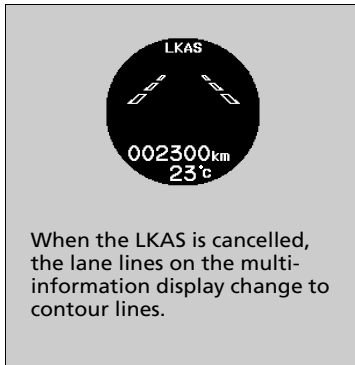

■ **The system operation is suspended if you:**

- Turn the wipers to **LO**, **HI** or **MIST** and operate continuously.
 - ▶ Turning the wipers off resumes the LKAS.
- Decrease the vehicle speed to 64 km/h (40 mph) or less.
 - ▶ Increasing the vehicle speed to 72 km/h (45 mph) or more resumes the LKAS.
- Depress the brake pedal.
 - ▶ The LKAS resumes and starts detecting the lane lines again once you release the brake pedal.

■ **The LKAS may automatically be suspended when:**

- The system fails to detect lane lines.
- The steering wheel is quickly turned.
- You fail to steer the vehicle.
- The vehicle runs on a curved road over the speed limit.

Once these conditions no longer exist, the LKAS automatically resumes.

■ **The LKAS may automatically be cancelled when:**

- The camera temperature gets too high.
- The camera behind the rearview mirror, or the area around the camera, including the windscreen, gets dirty.
- When driving through a sharp curve.
- When driving at a speed in excess of approximately 180 km/h (112 mph).
- When the ABS or VSA systems engage.

A beeper will sound if the LKAS is automatically cancelled.

■ LKAS Conditions and Limitations

The system may not detect lane markings and therefore may not keep the vehicle in the middle of a lane under certain conditions, including the following:

■ Environmental conditions

- Driving in bad weather (rain, fog, snow, etc.).
- Sudden changes between light and dark, such as an entrance or exit of a tunnel.
- There is little contrast between lane lines and the roadway surface.
- Driving into low sunlight (e.g., at dawn or dusk).
- Strong light is reflected onto the roadway.
- Driving in the shadows of trees, buildings, etc.
- Shadows of adjacent objects are parallel to lane markings.
- Roadway objects or structures are misinterpreted as lane markings.
- Reflections on the interior of the front windscreen.

■ Roadway conditions

- Driving on a snowy or wet roadway (obscured lane marking, vehicle tracks, reflected lights, road spray, high contrast).
- Driving on a road with temporary lane markings.
- Faint, multiple, or varied lane markings are visible on the roadway due to road repairs or old lane markings.
- The roadway has merging, split, or crossing lines (e.g., such as at an intersection or crosswalk).
- The lane markings are extremely narrow, wide, or changing.
- The vehicle in front of you is driving near the lane lines.
- The road is hilly or the vehicle is approaching the crest of a hill.
- Driving on rough or unpaved roads, or over bumpy surfaces.
- When objects on the road (curb, guard rail, pylons, etc.) are recognised as white lines (or yellow lines).
- When driving on roads with double lines.

■ Vehicle conditions

- Headlight lenses are dirty or the headlights are not properly adjusted.
- The outside of the windscreen is streaked or blocked by dirt, mud, leaves, wet snow, etc.
- The inside of the windscreen is fogged.
- The camera temperature gets too hot.
- An abnormal tyre or wheel condition (wrong sized, varied size or construction, improperly inflated tyre, etc.).
- The vehicle is tilted due to a heavy load or suspension modifications.

Vehicle Stability Assist (VSA) System

VSA helps to stabilize the vehicle during cornering if the vehicle turns more, or less than what was intended. It also assists in maintaining traction on slippery surfaces. It does so by regulating engine output and selectively applying the brakes.

■ VSA Operation

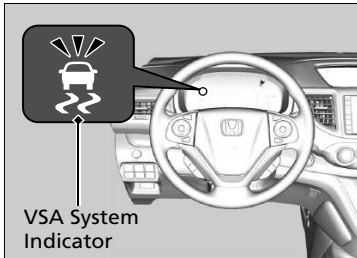

When VSA activates, you may notice that the engine does not respond to the accelerator. You may also notice some noise from the hydraulic system. You will also see the indicator blink.

▣ Vehicle Stability Assist (VSA) System

The VSA may not function properly if tyre type and size are mixed. Make sure to use the same size and type of tyre, and the air pressures as specified.

When the VSA indicator comes on and stays on while driving, there may be a problem with the system. While this may not interfere with normal driving, have your vehicle checked by a dealer immediately.

VSA cannot enhance stability in all driving situations and does not control the entire braking system. You still need to drive and corner at speeds appropriate for the conditions and always leave a sufficient margin of safety.

VSA On and Off

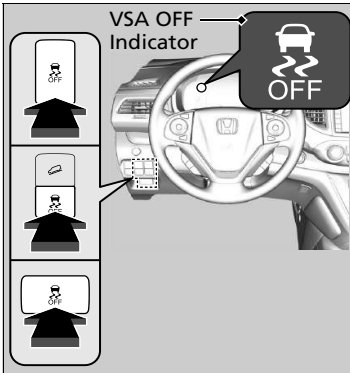

This button is on the driver side control panel. To partially turn the VSA features on and off, press and hold it until you hear a beep.

The traction control stops fully functioning, allows the wheels to spin more freely at low speed. The VSA OFF indicator will also come on.

To turn it on again, press the  (VSA OFF) button until you hear a beep.

VSA is turned on every time you start the engine, even if you turned it off the last time you drove the vehicle.

Vehicle Stability Assist (VSA) System

With the  button pressed, your vehicle will have normal braking and cornering ability, but VSA traction and stability enhancement becomes less effective.

In certain unusual conditions when your vehicle gets stuck in shallow mud or fresh snow, it may be easier to free it with the VSA temporarily switched off.

When the  button is pressed, the traction control function becomes less effective. This allows for the wheels to spin more freely at low speed. You should only attempt to free your vehicle with the VSA off if you are not able to free it when the VSA is on.

Immediately after freeing your vehicle, be sure to switch VSA on again. We do not recommend driving your vehicle with the VSA system switched off.

You may hear a motor sound coming from the engine compartment while system checks are being performed immediately after starting the engine or while driving. This is normal.

Models with halogen bulbs

Adjusting Headlight Distribution

Driving the right-hand type vehicle in right-hand traffic, or the left-hand type vehicle in left-hand traffic causes headlight glare to oncoming vehicles. You need to alter the headlight beam distribution using masking tape.

Adjusting Headlight Distribution

Be careful not to adhere the tape to an incorrect location. If the headlight beam is distributed incorrectly, it may not comply with your country's legal requirements. Ask your dealer for details.

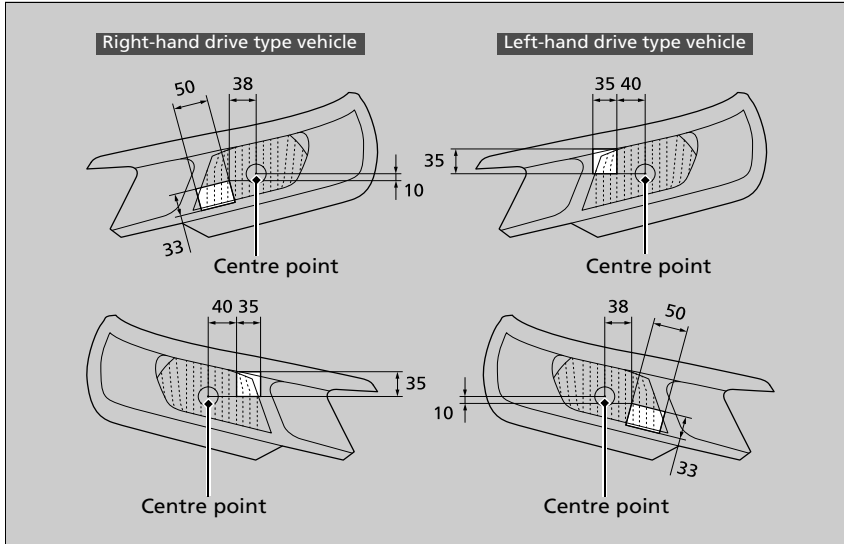

1. Prepare for two rectangular pieces of masking tape, measuring 33 mm wide and 50 mm long, and 35 mm wide and 35 mm long.
 - Use masking tape that can shut out light, such as seal type waterproof vinyl.
2. Affix the tape to the lens as shown.

Blind Spot Information System*

Is designed to detect vehicles in specified alert zones adjacent to your vehicle, particularly in harder to see areas commonly known as “blind spots.”

Blind Spot Information System*

⚠ WARNING

Failure to visually confirm that it is safe to change lanes before doing so may result in a crash and serious injury or death.

Do not rely only on the blind spot information system when changing lanes.

Always look in your mirrors, to either side of your vehicle, and behind you for other vehicles before changing lanes.

Important Safety Reminder

Like all assistance systems, blind spot information system has limitations. Over reliance on blind spot information system may result in a collision.

* Not available on all models

Continued

■ How the system works

- Radar sensors detect a vehicle in the alert zone when your vehicle is moving forward at 20 km/h (12 mph) or faster.

Alert zone range

- A: Approx. 0.5 m (1.6 ft.)
- B: Approx. 3 m (10 ft.)
- C: Approx. 3 m (10 ft.)

Radar Sensors:
underneath the
rear bumper
corners

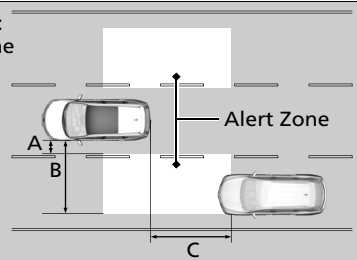

▣ Blind Spot Information System*

You can change the setting for blind spot information system.

▣ **Customized Features** P. 133

Turn the system off when towing a trailer.

The system may not work properly for the following reasons:

- The added mass tilts the vehicle and changes the radar coverage.
- The trailer itself can be detected by the radar sensors, causing the blind spot information system alert indicators to come on.

The system is for your convenience only. Even if an object is within the alert zone, the following situations may occur.

- The blind spot information system alert indicator may not come on due to obstruction (splashes, etc.) even without the  MID appearing.
- The blind spot information system alert indicator may come on even with the message appearing.

The blind spot information system alert indicator may not come on under the following conditions:

- A vehicle does not stay in the alert zone for more than two seconds.
- A vehicle is parked in a side lane.
- The speed difference between your vehicle and the vehicle you are passing is greater than 10 km/h (6 mph).
- An object not detected by the radar sensors approaches or passes your vehicle.
- A vehicle running in the adjacent lane is a motorcycle or other small vehicle.

The system does not operate when in .

■ When the system detects a vehicle

Blind Spot Information Alert Indicator:
Located the outside rearview mirror on both sides.

■ Comes on when

- A vehicle enters the alert zone from behind to overtake you with a speed difference of no more than 50 km/h (31 mph) from your vehicle.
- You pass a vehicle with a speed difference of no more than 20 km/h (12 mph).

■ Blinks and the beeper sounds when

You move the turn signal lever in the direction of the detected vehicle. The beeper sounds three times.

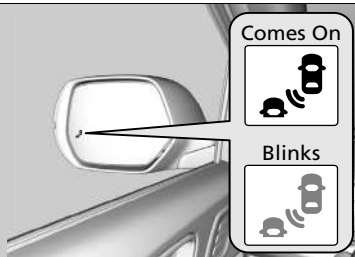

▣ Blind Spot Information System*

Blind spot information system may be adversely affected when:

- Objects (guard rails, poles, trees, parked vehicles, building, wall, etc) are detected.
- An object that does not reflect radio waves well, such as a motorcycle, is in the alert zone.
- Driving on a curved road.
- A vehicle is moving from a far lane to the adjacent lane.
- The system picks up external electrical interference.
- The rear bumper or the sensors have been improperly repaired or the rear bumper has been deformed.
- The orientation of the sensors has been changed.
- In bad weather (rain, snow, and fog).
- Driving on a bumpy road.
- Making a short turn that slightly tilts the vehicle.

For proper blind spot information system use:

- Always keep the rear bumper corner area clean.
- Do not cover the rear bumper corner area with labels or stickers of any kind.
- Take your vehicle to a dealer if you need the rear bumper corner area or the radar sensors to be repaired, or the rear bumper corner area is strongly impacted.

* Not available on all models

Deflation Warning System

Instead of directly measuring the pressure in each tyre, the deflation warning system on this vehicle monitors and compares the rolling radius and rotational characteristics of each wheel and tyre while you are driving to determine if one or more tyres are significantly under-inflated. This will cause the low tyre pressure/deflation warning system indicator to come on and a message to appear on the multi-information display.

Deflation Warning System Calibration

You must start deflation warning system calibration every time you:

- Adjust the pressure in one or more tyres.
- Rotate the tyres.
- Replace one or more tyres.

Before calibrating the deflation warning system:

- Set the cold tyre pressure in all four tyres.

Make sure:

- The vehicle is at a complete stop.

Manual transmission models

- The parking brake is applied.

Automatic transmission models

- The transmission is in **P**.

All models

- The ignition switch is in ON **II***1.

*1: Models with the keyless access system have an **ENGINE START/STOP** button instead of an ignition switch.

Deflation Warning System

The system does not monitor the tyres when driving at low speed.

Conditions such as low ambient temperature and altitude change directly affect tyre pressure and can trigger the low tyre pressure/deflation warning system indicator to come on.

Tyre pressure checked and inflated in:

- Warm weather can become under-inflated in colder weather.
- Cold weather can become over-inflated in warmer weather.

The low tyre pressure indicator will not come on as a result of over inflation.

The deflation warning system may not function properly if tyre type and size are mixed.

Make sure to use the same size and type of tyre.

🔍 **Checking and Maintaining Tyres** P. 580

The low tyre pressure/deflation warning system indicator may come on with a delay or may not come on at all when:

- You rapidly accelerate, decelerate, or turn the steering wheel.
- You drive on snowy or slippery roads.
- Snow chains are used.

The low tyre pressure/deflation warning system indicator may come on under the following conditions:

- A compact spare tyre* is used.
- There is a heavier and uneven load on the tyres, such as when towing a trailer, than the condition at calibration.
- Snow chains are used.

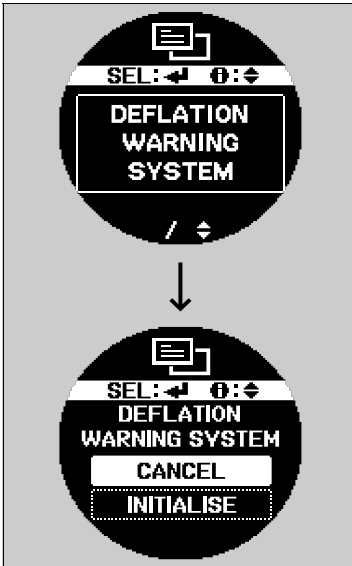

You can calibrate the system from the customized features on the multi-information display.

1. Press **▲①/▼** button until  appears on the display, then press the **SEL/RESET** button.
 - ▶ **SPEED ALARM** appears on the display.
 2. Press button until **DEFLATION WARNING SYSTEM** appears on the display.
 3. Press the **SEL/RESET** button.
 - ▶ The display switches to the customization setup screen, where you can select **CANCEL** or **INITIALISE**.
 4. Press the **▲①/▼** button and select **INITIALISE**, then press the **SEL/RESET** button.
 - ▶ **COMPLETED** screen appears, then the display returns to the customization menu screen.
- The calibration process finishes automatically.

☒ Deflation Warning System Calibration

- Deflation Warning System cannot be calibrated if a compact spare tyre* is installed.
- The calibration process requires approximately 30 minutes of cumulative driving at speeds between 40–100 km/h (25–62 mph).
- During this period, if the ignition is turned on and the vehicle is not moved within 45 seconds, you may notice the low tyre pressure indicator comes on briefly. This is normal and indicates that the calibration process is not yet complete.

If the snow chains are installed, remove them before calibrating the deflation warning system.

If the low tyre pressure/deflation warning system indicator comes on even when the properly inflated specified regular tyres are installed, have the vehicle checked by a dealer.

We recommend that the tyres be replaced with the same brand, model, and size as the originals. Ask a dealer for details.

* Not available on all models

REAL TIME AWD with Intelligent Control System*

Your vehicle is equipped with the AWD system. When the system senses a loss of front wheel traction, it automatically transfers some power to the rear wheels. This allows you to utilize all available traction and may increase mobility.

You still need to exercise the same care when accelerating, steering, and braking that you would in a two wheel drive vehicle.

If you excessively spin all four wheels and overheat the AWD system only the front wheels receive power. Stop until the system cools down.

REAL TIME AWD with Intelligent Control System*

NOTICE

Do not continuously spin the front tyres of your vehicle. Continuously spinning the front tyres can cause transmission or rear differential damage.

The AWD system may not function properly if tyre type and size are mixed. Make sure to use the same size and type of tyre, and the air pressures as specified.

➤ **Tyre and Wheel Replacement** P. 582

Brake System

Parking Brake

Use the parking brake to keep the vehicle stationary when parking.

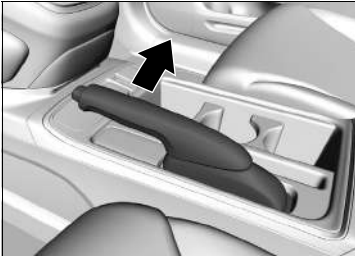

To apply:

Pull the lever fully up without pressing the release button.

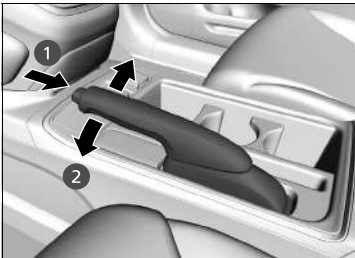

To release:

1. Pull the lever slightly, and press and hold the release button.
2. Lower the lever down all the way, then release the button.

▣ Parking Brake

NOTICE

Release the parking brake fully before driving. The rear brakes and axle can be damaged if you drive with the parking brake applied.

If you start driving without fully releasing the parking brake, a buzzer sounds as a warning, and  appears on the multi-information display.

Always set the parking brake firmly, in particular if you are parked on an incline.

Continued

■ Foot Brake

Your vehicle is equipped with disc brakes at all four wheels. A vacuum power assist helps reduce the effort needed on the brake pedal. The brake assist system increases the stopping force when you depress the brake pedal hard in an emergency situation. The anti-lock brake system (ABS) helps you retain steering control when braking very hard.

➤ **Brake Assist System** P. 491

➤ **Anti-lock Brake System (ABS)** P. 490

☒ Foot Brake

Check the brakes after driving through deep water, or if there is a buildup of road surface water. If necessary, dry the brakes by lightly depressing the pedal several times.

If you hear a continuous metallic friction sound when applying the brakes, the brake pads need to be replaced. Have the vehicle checked by a dealer.

Constantly using the brake pedal while going down a long hill builds up heat, which reduces the brake effectiveness. Apply engine braking by taking your foot off the accelerator pedal and downshifting to a lower gear. With manual transmission use a lower gear for greater engine braking.

Do not rest your foot on the brake pedal while driving, as it will lightly apply the brakes and cause them to lose effectiveness over time and reduce pad life. It will also confuse drivers behind you.

■ Hill Descent Control System*

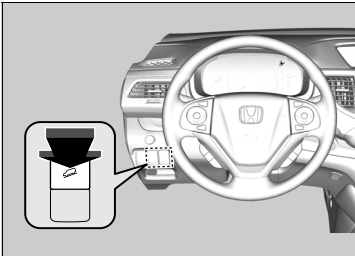

Keeps the vehicle speed steady while going down hills without depressing the accelerator or brake pedal.

■ When to use

The system activates when the vehicle speed is between around 10 km/h (6 mph) and 20 km/h (12 mph).

■ Hill descent control system on and off

With the ignition switch in ON ^{*1}, press the hill descent control system button to turn the system on and off.

- ▶ When the system is on (ready to use), the hill descent control system indicator comes on.
The indicator blinks while the system is in operation.

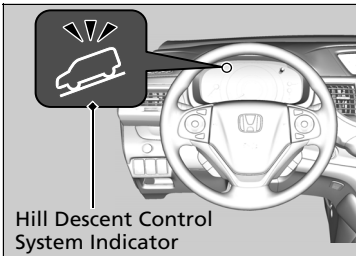

* 1: Models with the keyless access system have an **ENGINE START/STOP** button instead of an ignition switch.

* Not available on all models

▣ Hill Descent Control System*

The brake lights automatically come on while the system is in operation.

The system is turned off every time you stop the engine, even if you turned it on the last time you drove the vehicle.

Anti-lock Brake System (ABS)

■ ABS

Helps prevent the wheels from locking up, and helps you retain steering control by pumping the brakes rapidly, much faster than you.

The electronic brake distribution (EBD) system, which is part of the ABS, also balances the front-to-rear braking distribution according to vehicle loading.

You should never pump the brake pedal. Let the ABS work for you by always keeping firm, steady pressure on the brake pedal. This is sometimes referred to as “stomp and steer.”

■ ABS operation

The brake pedal may pulsate slightly when the ABS is working. Keep holding the pedal firmly down. On dry pavement, you will need to press on the brake pedal very hard before the ABS activates. However, you may feel the ABS activate immediately if you are trying to stop on snow or ice.

When the vehicle speed goes under 10 km/h (6 mph), the ABS stops.

⚠ Anti-lock Brake System (ABS)

NOTICE

The ABS may not function correctly if you use an incorrect tyre type and size.

When the **ABS** indicator comes on while driving, there may be a problem with the system. While normal braking is not affected, there is a possibility of the ABS not operating. Have the vehicle checked by a dealer immediately.

The ABS does not reduce the time or distance it takes to stop the vehicle. It only helps with steering control during hard braking.

In the following cases, your vehicle may need more stopping distance than a vehicle without the ABS:

- When driving on rough road surfaces, including when driving on uneven surfaces, such as gravel or snow.
- When tyre chains are installed.

You may hear a motor sound coming from the engine compartment while system checks are being performed immediately after starting the engine or while driving. This is normal.

Brake Assist System

■ Brake Assist System

Designed to assist the driver by generating greater braking force when you depress the brake pedal hard during emergency braking.

■ Brake assist system operation

Press the brake pedal firmly for more powerful braking.

When brake assist operates, the pedal may wiggle slightly and an operating noise may be heard. This is normal. Keep holding the brake pedal firmly down.

Emergency Stop Signal

Activates when you brake hard while driving at 60 km/h (37 mph) or above to alert drivers behind you about sudden braking by rapidly flashing the hazard warning lights. This may help to alert drivers behind you to take appropriate means to avoid a possible collision with your vehicle.

■ When the system activates:

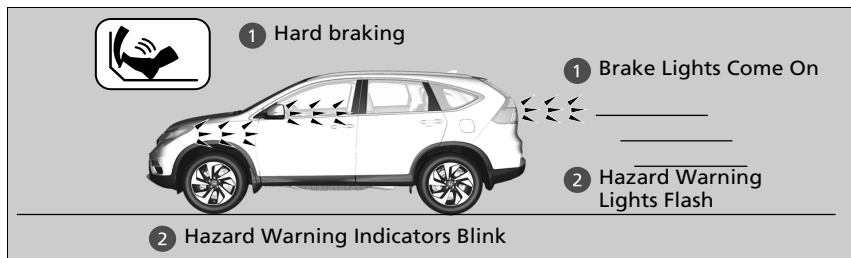

The hazard warning lights stop flashing when:

- You release the brake pedal.
- The ABS is deactivated.
- Your vehicle's decelerating speed becomes moderate.
- You press the hazard warning button.

☒ Emergency Stop Signal

The emergency stop light is not a system that can prevent a possible rear-end collision caused by your hard braking. It flashes the hazard warning lights at the time you are braking hard. It is always recommended to avoid hard braking unless it is absolutely necessary.

The emergency stop light system does not activate with the hazard warning button pressed in.

If the ABS stops working for a certain period of time during braking, the emergency stop light system may not activate at all.

Collision Mitigation Braking System (CMBS)*

Can assist you when there is a possibility of your vehicle colliding with a vehicle or a pedestrian detected in front of yours.

The CMBS is designed to alert you when a potential collision is determined, as well as to reduce your vehicle speed when a collision is deemed unavoidable to help minimize collision severity.

■ How the system works

When to use

The camera is located behind the rearview mirror. ——— The radar sensor is in the front grille. ———

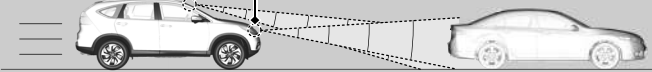

The system starts monitoring the roadway ahead when your vehicle speed is about 5 km/h (3 mph) and there is a vehicle in front of you.

The CMBS activates when:

- The speed difference between your vehicle and a vehicle or pedestrian detected in front of you becomes about 5 km/h (3 mph) and over with a chance of a collision.
- Your vehicle speed is about 100 km/h (62 mph) or less and there is a chance of a collision with an oncoming detected vehicle or a pedestrian in front of you.

▣ Collision Mitigation Braking System (CMBS)*

Important Safety Reminder

The CMBS is designed to reduce the severity of an unavoidable collision. It does not prevent collision nor stop the vehicle automatically. It is still your responsibility to operate the brake pedal and steering wheel appropriately according to the driving conditions.

The CMBS may not activate or may not detect a vehicle in front of your vehicle under certain conditions:

▣ **CMBS Conditions and Limitations** P. 498

You can read about handling information for the camera equipped with this system.

▣ **Front Sensor Camera*** P. 439

The camera in the CMBS is also designed to detect pedestrians.

However, this pedestrian detection feature may not activate or may not detect a pedestrian in front of your vehicle under certain conditions.

Refer to the ones indicating the pedestrian detection limitations from the list.

▣ **CMBS Conditions and Limitations** P. 498

■ When the system activates

The system provides visual and audible alerts of a possible collision, and stops if the collision is avoided.

- ▶ Take appropriate action to prevent a collision (apply the brakes, change lanes, etc.)

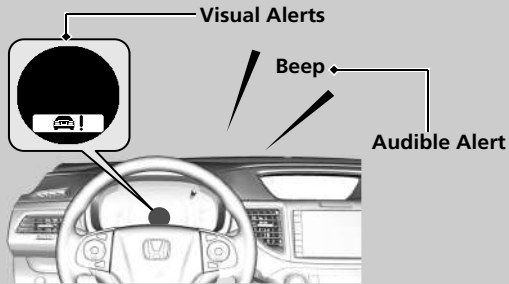





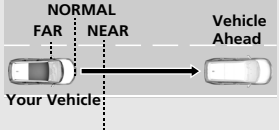

At system's earliest collision alert stage, you can change the distance (**FAR/NORMAL/NEAR**) between vehicles at which alerts will come on through multi-information display setting options.

- **List of customizable options** P. 148

■ Collision Alert Stages

The system has three alert stages for a possible collision. However, depending on the circumstances, CMBS may not go through all of the stages before initiating the last stage.

Distance between vehicles	CMBS			
	The sensors detect a vehicle	E-pretensioner	Audio & Visual WARNINGS	Braking
<p>Stage one</p> 	<p>There is a risk of a collision with the vehicle ahead of you.</p>	<p>—</p>	<p>The  flashes on the multi-information display. You can change the distance to flash this warning (FAR/NORMAL/NEAR).</p> <p>► List of customizable options P. 148</p>	<p>—</p>
<p>Stage two</p> 	<p>The risk of a collision has increased, time to respond is reduced.</p>	<p>Retracts the driver's seat belt gently a few times, providing a physical warning.</p> 	<p>A beep sounds and  flashes on the multi-information display.</p>	<p>Lightly applied</p>
<p>Stage three</p> 	<p>The CMBS determines that a collision is unavoidable.</p>	<p>Forcefully tightens driver and front passenger seat belts.</p> 		<p>Forcefully applied</p>

■ CMBS On and Off

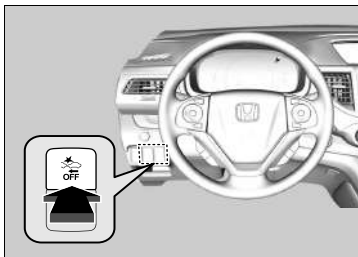

Press this button until the beeper sounds to switch the system on or off.

When the CMBS is off:

- The CMBS indicator in the instrument panel comes on.
- A message on the multi-information display reminds you that the system is off.

The CMBS is in the previously selected ON or OFF setting each time you start the engine.

▣ Collision Mitigation Braking System (CMBS)*

The CMBS may automatically shut off, and the CMBS indicator will come and stay on under certain conditions.

▣ **CMBS Conditions and Limitations** P. 498

■ With Little Chance of a Collision

The CMBS may activate even when you are aware of a vehicle ahead of you, or when there is no vehicle ahead. Some examples of this are:

■ When Passing

Your vehicle approaches another vehicle ahead of you and you change lanes to pass.

■ At an intersection

Your vehicle approaches or passes another vehicle that is making a left or right turn.

■ On a curve

When driving through curves, your vehicle comes to a point where an oncoming vehicle is right in front of you.

■ Through a low bridge at high speed

You drive under a low or narrow bridge at high speed.

■ Speed bumps, road work sites, train tracks, roadside objects, etc.

You drive over speed bumps, steel road plates, etc., or your vehicle approaches train tracks or roadside objects [such as a traffic sign and guard rail] on a curve or, when parking, stationary vehicles and walls.

▣ Collision Mitigation Braking System (CMBS)*

For the CMBS to work properly:

Always keep the radar sensor cover clean.

Never use chemical solvents or polishing powder for cleaning the sensor cover. Clean it with water or a mild detergent.

Do not put a sticker on the emblem or replace the emblem.

If you need the radar sensor to be repaired, or removed, or the radar sensor cover is strongly impacted, turn off the system by pressing the CMBS off button and take your vehicle to a dealer.

* Not available on all models

■ CMBS Conditions and Limitations

The system may automatically shut off and the CMBS indicator will come on under certain conditions. Some examples of these conditions are listed below. Other conditions may reduce some of the CMBS functions.

📷 **Front Sensor Camera*** P. 439

■ Environmental conditions

- Driving in bad weather (rain, fog, snow, etc.).
- Sudden changes between light and dark, such as an entrance or exit of a tunnel.
- There is little contrast between objects and the background.
- Driving into low sunlight (e.g., at dawn or dusk).
- Strong light is reflected onto the roadway.
- Driving in the shadows of trees, buildings, etc.
- Reflections on the interior of the front windscreen.
- Roadway objects or structures are misinterpreted as vehicles and pedestrians.

■ Roadway conditions

- Driving on a snowy or wet roadway (obscured lane marking, vehicle tracks, reflected lights, road spray, high contrast).
- The road is hilly or the vehicle is approaching the crest of a hill.
- Driving on curvy, winding, or undulating roads.

■ Vehicle conditions

- Headlight lenses are dirty or the headlights are not properly adjusted.
- The outside of the windscreen is blocked by dirt, mud, leaves, wet snow, etc.
- The inside of the windscreen is fogged.
- An abnormal tyre or wheel condition (wrong sized, varied size or construction, improperly inflated tyre, etc.).
- When tyre chains are installed.
- The vehicle is tilted due to a heavy load or suspension modifications.
- The camera temperature gets too hot.
- Driving with the parking brake applied.
- When the radar sensor in the front grille gets dirty.

■ Detection limitations

- A vehicle or pedestrian suddenly crosses in front of you.
- The distance between your vehicle and the vehicle or pedestrian ahead of you is too short.
- When you accelerate rapidly and approach the vehicle or pedestrian ahead of you at high speed.
- The speed difference between your vehicle or pedestrian and a vehicle in front of you is significantly large.
- A vehicle cuts in front of you at a slow speed, and it brakes suddenly.
- The vehicle ahead of you is a motorcycle, bicycle, mobility scooter or other small vehicle.
- When there are animals in front of your vehicle.
- When you drive on a curved, winding or undulating road that makes it difficult for the sensor to properly detect a vehicle in front of you.
- An oncoming vehicle suddenly comes in front of you.
- Another vehicle suddenly comes in front of you at an intersection, etc.
- Your vehicle abruptly crosses over in front of an oncoming vehicle.
- When driving through a narrow iron bridge.
- When the lead vehicle suddenly slows down.

»» Detection limitations

Limitations to pedestrians only

- When there is a group of people in front of your vehicle walking together side by side.
- Surrounding conditions or belongings of the pedestrian alter the pedestrian's shape, preventing the system from recognizing that the person is a pedestrian.
- When the pedestrian is slouching or squatting.
- When the pedestrian is shorter than about 1 metre (3 feet) or taller than about 2 metre (7 feet) in height.
- When a pedestrian blends in with the background.
- When a pedestrian is bent over or squatting, or when their hands are raised or they are running.
- When several pedestrians are walking ahead in a group.
- When the camera cannot correctly identify that a pedestrian is present due to an unusual shape (holding luggage, body position, size).

■ Automatic shutoff

The CMBS may automatically shut itself off and the CMBS indicator comes and stays on when:

- The temperature inside the system is high.
- You drive off-road or on a mountain road, or curved and winding road for an extended period.
- An abnormal tyre condition is detected (wrong tyre size, flat tyre, etc.).
- The camera behind the rearview mirror, or the area around the camera, including the windscreen, gets dirty.

Once the conditions that caused the CMBS to shut off improve or are addressed (e.g., cleaning), the system comes back on.

City-Brake Active system*

Can assist you when driving at a low speed, and there is a possibility of your vehicle colliding with a vehicle detected right in front of yours. The City-Brake Active system is designed to alert you when a potential collision is determined, as well as to reduce your vehicle speed when a collision is deemed unavoidable to help to minimise collision severity.

How the System Works

A laser sensor starts to monitor if there is a vehicle in front of you when your vehicle speed is between about 5 km/h (3 mph) and about 32 km/h (20 mph).

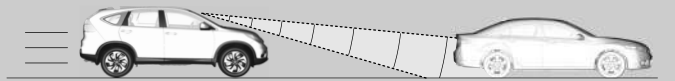

Laser Sensor

The laser sensor is behind the rearview mirror.

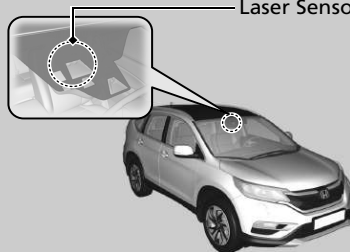

The system activates when the speed difference between your vehicle and a vehicle detected in front of you is about 5 km/h (3 mph) to 32 km/h (20 mph) with a high chance of collision.

The system don't activate when shift position is **R**.

City-Brake Active system*

⚠ WARNING

Do not rely on the city-brake active system to avoid every possible frontal collision.

Failure to pay close attention to a vehicle ahead of you, and to operate the brake pedal appropriately according to the situation can cause serious injury or death.

For the system to work properly:

- Always keep the upper part of the windscreen clean. Wipe away any dirt, ice, frost, etc.
- Do not impact the area around the laser sensor when cleaning the windscreen.
- Do not remove the laser sensor from the unit.

Manual transmission models

When the vehicle comes to a stop with the system's automatic braking, the engine may stop. To start the engine again, follow the standard procedure.

► **Starting the Engine** P. 397, 400

Collision Alert Stages

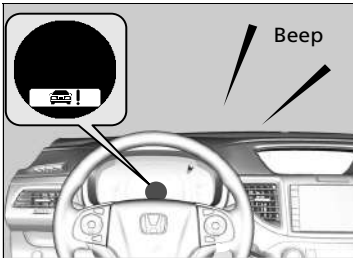

The beeper sounds, and a CTBA warning blinks on the multi-information display, and hard braking is applied when a possible collision becomes likely unavoidable. This automatic braking with the system activated is cancelled after the vehicle comes to a complete stop. Apply the brakes accordingly. A message indicating that the system has activated appears on the multi-information display after the vehicle is stopped.

Display Warning and Information Messages P. 108

The system may be cancelled if you operate the brake pedal, the accelerator pedal, or the steering wheel to avoid the collision.

City-Brake Active system*

The system may not activate or may not detect a vehicle in front of your vehicle under the following conditions:

- A vehicle in front of you is diagonally, horizontally, or frontally positioned.
- The distance between your vehicle and the vehicle ahead of you is too short.
- The speed difference between your vehicle and a vehicle ahead of you is large.
- A vehicle cuts in front of you, and brakes suddenly.
- You rapidly accelerate your vehicle, getting closer to a vehicle ahead.
- An oncoming vehicle suddenly drifts in front of you.
- Your vehicle suddenly drifts into the oncoming lane.
- A vehicle suddenly crosses in front of you at intersections.
- When driving in bad weather (heavy rain, fog, snow, etc.).
- When driving on a curved or winding road.
- A vehicle in front of you is extremely dirty, making it difficult to reflect radio waves well.
- You depress the brake pedal or turn the steering wheel to avoid a collision.
- A vehicle ahead of you is a motorcycle or other small vehicle the sensor cannot detect properly.
- The upper part of the windshield around the laser sensor is covered with dirt, ice frost, etc.

■ The System On and Off

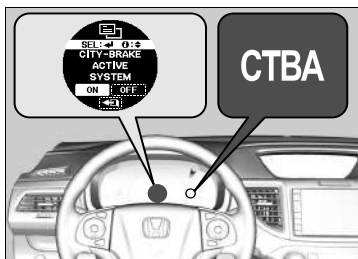

You can turn the system on and off using the multi-information display.

➤ **Customized Features** P. 145

When the system is off, the **CTBA** indicator in the instrument panel comes on.

City-Brake Active system is turned on every time you turn the ignition switch to ON **II***¹, even if you turned it off the last time you drove the vehicle.

⊗ City-Brake Active system*

The system may not activate while you are fully depressing the accelerator pedal.

The system may automatically shut off, and the **CTBA** indicator can come on and the message can appear on the multi-information display when:

- The temperature around the laser sensor on the upper part of the windscreen becomes high.
- The area around the laser sensor, which is located in the upper part of the windscreen, is covered with obstacles, such as dirt, ice and frost.
- The bonnet is covered with obstacles such as snow.

Stop your vehicle in a safe place, and

- Use the air conditioning system to cool down the interior if the laser sensor temperature is high.
- Remove any obstacles such as dirt and snow from the windscreen and bonnet.

➤ **Indicators** P. 84

Once the conditions that caused the system to shut off improve, the system comes back on.

*1: Models with the keyless access system have an **ENGINE START/STOP** button instead of an ignition switch.

* Not available on all models

■ With Little Chance of a Collision

The system may activate even when you are aware of a vehicle ahead of you, or when there is no vehicle ahead. Some examples of this are:

■ When passing

Your vehicle approaches another vehicle ahead of you and you change lanes to pass.

■ At an intersection

Your vehicle approaches or passes another vehicle that is making a left or right turn.

■ Through a low bridge

You drive under a low or narrow bridge.

■ Speed bumps, road work sites, train tracks, roadside objects, etc.

You drive over speed bumps, steel road plates, etc., or your vehicle approaches train tracks or roadside objects, such as a traffic sign and guard rail, on a curve.

■ When parking

Your vehicle approaches a stationary vehicle or wall.

☒ City-Brake Active system*

Turn off the system when:

- You use a dynamometer or put the wheels on a roller.
- Driving off road or on a mountainous road obstructed with branches and leaves.

Take your vehicle to a dealer if you need the laser sensor or area around it to be repaired, or removed, or the area around the laser sensor is strongly impacted.

Do not alter your vehicle's suspension. Changing the vehicle height prevents the system to work properly.

Make sure to use the same size and type of tyre for all four wheels. Use the tyres that are all in about the same condition with adequate tread. If not, the system may operate abnormally.

The system may not work properly if:

- Your vehicle has heavy load in the rear.
- Tyres are over- or underinflated.

* Not available on all models

About the Laser Equipped in the System

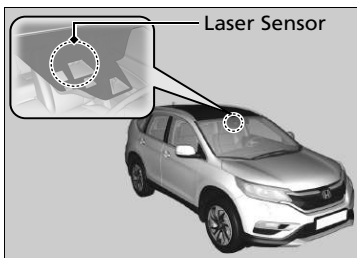

The City-Brake Active system unit, including the laser sensor, is located behind the rearview mirror.

Following lists the classified specifications of the laser used in this system according to the IEC requirements. The same information can be found in the IEC60825-1 standard labels.

Laser classification

Max average power:	45 mW
Pulse duration:	33 ns
Wavelength:	905 nm
Average power angle (horizontal × vertical)	28 × 12

City-Brake Active system*

⚠ WARNING

Handling the laser sensor improperly can lead to eye injury.

To avoid eye injury, Keep the following:

- Do not take the sensor apart from the unit.
- Never look at the sensor within a 100 mm distance using an optical device, such as a magnified glass, microscopes, and an object lens.

Laser Classification Label



Laser Explanation Label

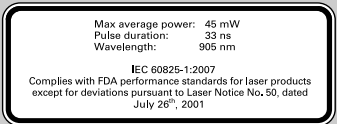

When Stopped

1. Depress the brake pedal firmly.
2. Firmly apply the parking brake.

Automatic transmission models

3. Change the gear position to **P**.

Manual transmission models

3. Move the shift lever to **R** or **1**.

Diesel models

4. Keep idling the engine for about 10 seconds.
5. Turn off the engine.

Always set the parking brake firmly, in particular if you are parked on an incline.

▣ Parking Your Vehicle

Do not park your vehicle near flammable objects, such as dry grass, oil, or timber. Heat from the exhaust can cause a fire.

▣ When Stopped

9-speed automatic transmission models

⚠ WARNING

The vehicle can roll away if left unattended without confirming that Park is engaged.

Always keep your foot on the brake pedal until you have confirmed that **P** is shown on the gear position Indicator.

Automatic transmission models

NOTICE

The following can damage the transmission:

- Depressing the accelerator and brake pedals simultaneously.
- Holding the vehicle in place when facing uphill by depressing the accelerator pedal.
- Changing into **P** before the vehicle stops completely.

Diesel models

Keep idling the engine for a few minutes if your vehicle has towed a trailer.

The engine idling may be prohibited in some countries. Check and follow your local legal requirements.

Continued

☒ When Stopped

In extremely cold temperatures, the parking brake may freeze up if applied. If such temperatures are expected, do not apply the parking brake but, if parking on a slope, either turn the front wheels so they will contact the curb if the vehicle rolls down the slope or block the wheels to keep the vehicle from moving. If you do not take either precaution, the vehicle may roll unexpectedly, leading to a crash.

Parking Sensor System*

The corner and centre sensors monitor obstacles behind your vehicle, and the beeper and i-multi-information display or audio/information screen* lets you know the approximate distance between your vehicle and the obstacle.

■ The sensor location and range

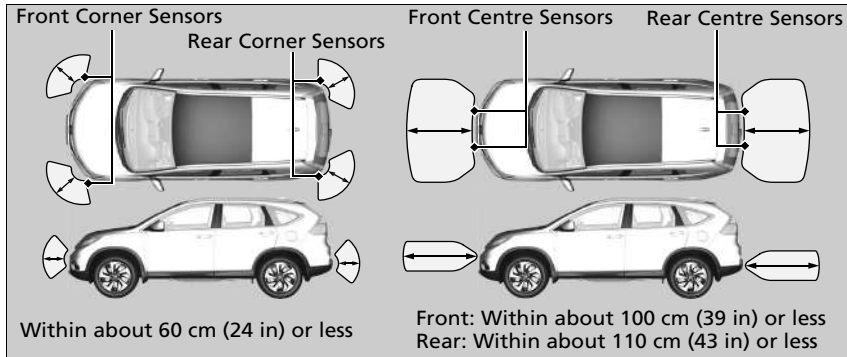

▣ Parking Sensor System*

Even the system is on, always confirm if there is no obstacle near your vehicle before parking.

The system may not work properly when:

- The sensors are covered with snow, ice mud or dirt.
- The vehicle is on uneven surface, such as grass, bumps, or a hill.
- The vehicle has been out in hot or cold weather.
- The system is affected by devices that emit ultrasonic waves.
- Driving in bad weather.

The system may not sense:

- Thin or low objects.
- Sonic-absorptive materials, such as snow, cotton, or sponge.
- Objects directly under the bumper.

Do not put any accessories on or around the sensors.

* Not available on all models

Continued

■ Parking sensor system on and off

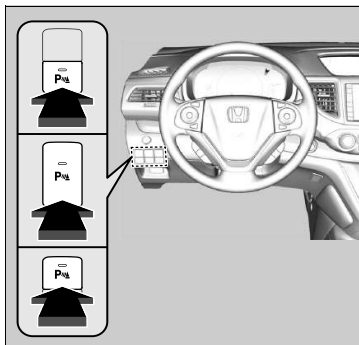

With the ignition switch in ON **[II]***1, press the parking sensor system button to turn on or off the system. The indicator in the button comes on when the system is on.

The front corner and front centre sensors start to detect an obstacle when the transmission is in any position other than **[P]** or **[R]**, and the vehicle speed is less than 8 km/h (5 mph).

The front corner, rear corner and rear centre sensors start to detect an obstacle when the transmission is in **[R]**, and the vehicle speed is less than 8 km/h (5 mph).

Manual transmission models

You also need to release the parking brake.

☒ Parking sensor system on and off

When you turn the ignition switch to ON **[II]***1, the system will be in the previously selected condition.

*1: Models with the keyless access system have an **ENGINE START/STOP** button instead of an ignition switch.

*1: Models with the keyless access system have an **ENGINE START/STOP** button instead of an ignition switch.

■ When the distance between your vehicle and obstacles behind becomes shorter

Length of the intermittent beep	Distance between the Bumper and Obstacle		Indicator	i-Multi-information display or Audio/information screen*
	Corner Sensors	Centre Sensors		
Moderate	—	Front: About 100-60 cm (39-24 inches) Rear: About 110-60 cm (43-24 inches)	Blinks in Yellow* ¹	<div data-bbox="1161 300 1469 348" style="border: 1px solid black; padding: 2px;">Models with Audio/information screen</div>  <p>Indicators: Where the sensor detects an obstacle lights</p> <div data-bbox="1259 553 1369 572" style="border: 1px solid black; padding: 2px;">All models</div>  <p>Indicators: Where the sensor detects an obstacle lights</p>
Short	About 60-45 cm (24-18 inches)	About 60-45 cm (24-18 inches)	Blinks in Amber	
Very short	About 45-35 cm (18-14 inches)	About 45-35 cm (18-14 inches)		
Continuous	About 35 cm (14 inches) or less	About 35 cm (14 inches) or less	Blinks in Red	

*1: At this stage, only the centre sensors detect obstacles.

* Not available on all models

■ Turning off All Rear Sensors

1. Make sure that the parking sensor system is not activated. Turn the ignition switch to LOCK **[0]***1.
2. Press and hold the parking sensor system button, and turn the ignition switch to ON **[II]***1.
3. Keep pressing the button for ten seconds. Release the button when the indicator in the button flashes.
4. Press the button again. The indicator in the button goes off.
 - The beeper sounds twice. The rear sensors are now turned off.

To turn the rear sensors on again, follow the above procedure. The beeper sounds three times when the rear sensors come back on.

▣ Turning off All Rear Sensors

When you set the gear position to **[R]**, the indicator in the parking sensor system button blinks as a reminder that the rear sensors have been turned off.

*1: Models with the keyless access system have an **ENGINE START/STOP** button instead of an ignition switch.

Cross Traffic Monitor*

Monitors the rear corner areas using the radar sensors when reversing, and alerts you if a vehicle approaching from a rear corner is detected.

The system is convenient especially when you are getting out of a parking space backwards.

ⓘ Cross Traffic Monitor*

CAUTION

Cross traffic monitor cannot detect all approaching vehicles and may not detect an approaching vehicle at all.

Failure to visually confirm that it is safe to back up the vehicle before doing so may result in a collision.

Do not solely rely on the system when reversing; always also use your mirrors, and look behind and to the sides of your vehicle before reversing.

The parking sensor system's alerting buzzer overrides the cross traffic monitor buzzer when the sensors are detecting obstacles at the closest range.

* Not available on all models

Continued

How the System Works

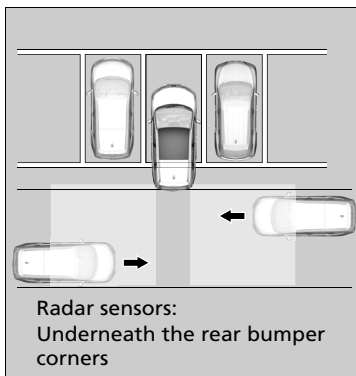

When a vehicle approaches from a rear corner, cross traffic monitor alerts you with a buzzer and a displayed warning.

The system activates when:

- Turn the ignition switch to ON **II***¹.
- Cross traffic monitor is turned on.
 - ▣ **Cross Traffic Monitor On and Off** P. 517
 - ▣ **Customized Features** P. 145, 323
- The transmission is in **R**.

▣ Cross Traffic Monitor*

Cross traffic monitor may not detect or may delay detecting an approaching vehicle, or may alert detection without an approaching vehicle under the following conditions:

- An obstacle, such as another vehicle and a wall, near your vehicle's rear bumper, is blocking the radar sensor's scope.
- Your vehicle is moving at the speed of about 5 km/h (3 mph) or higher.
- A vehicle is approaching at the speed other than between about 10 km/h (6 mph) and 25 km/h (16 mph).
- The system picks up external interference such as other radar sensors from another vehicle or strong radio wave transmitted from a facility nearby.
- Either corner of the rear bumper is covered with snow, ice, mud or dirt.
- When there is bad weather.
- Your vehicle is on an incline.
- Your vehicle is tilted due to a heavy load in the rear.
- Your vehicle is reversing towards a wall, a pole, a vehicle, and so on.
- The rear bumper or the sensors have been improperly repaired or the rear bumper has been deformed.

▣ **Have a vehicle checked by a dealer.**

*1: Models with the keyless access system have an **ENGINE START/STOP** button instead of an ignition switch.

The system will not detect a vehicle that approaches from directly behind your vehicle, nor will it provide alerts about a detected vehicle when it moves directly behind your vehicle.

The system does not detect or provide alerts for a vehicle that is moving away from your vehicle, and it may detect or alert for pedestrians, bicycles, or stationary objects.

▣ Cross Traffic Monitor*

For proper operation, always keep the rear bumper corner area clean. Do not cover the rear bumper corner area with labels or stickers of any kind.

* Not available on all models

Continued

When the System Detects a Vehicle

Models without audio/information screen

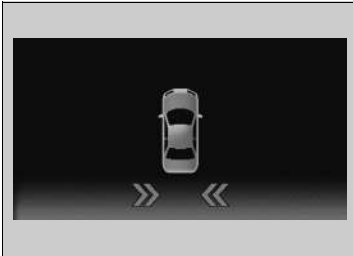

A warning icon appears on the i-multi-information display.

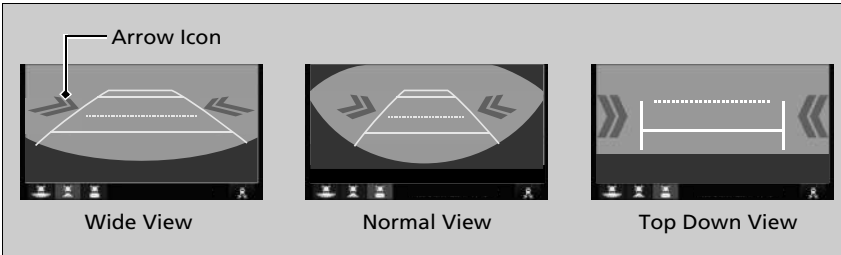

Models with audio/information screen





An arrow icon appears on the side a vehicle is approaching on the audio/information screen.



When the System Detects a Vehicle

Models without audio/information screen

If the  on the multi-information display changes to  in amber when the transmission is in **R**, mud snow or ice etc., may have accumulated in the vicinity of the sensor. The system is temporarily cancelled. Check the bumper corners for any obstructions, and thoroughly clean the area if necessary.

If  changes to  in amber when the transmission is in **R**, there may be a problem with the Cross Traffic Monitor system. Do not use the system and have your vehicle checked by a dealer.

Models with audio/information screen

If the  icon on the lower right changes to , there is a problem with the system. Have your vehicle checked by a dealer.

If the display remains the same with the transmission in **R**, there may be a problem with the multi-view rear camera system.

Models without audio/information screen

Cross Traffic Monitor On and Off

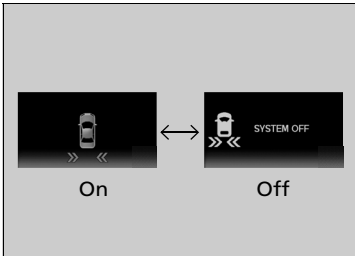



You can customize the setting of when to turn the system on from the i-multi-information display.

➤ **Customized Features** P. 145

Models with audio/information screen

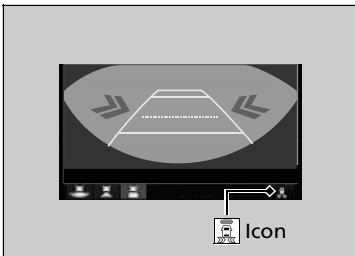
Cross Traffic Monitor On and Off



Tap  to turn the system on and off. The indicator (green) comes on with the system on.

You can also switch on and off the system using the audio/information screen.

➤ **Customized Features*** P. 323

* Not available on all models

About Your Rearview Camera

The i-multi-information display can display your vehicle's rear view. The display automatically changes to a rear view when the gear position is changed to **R**.

About Your Rearview Camera

The rear camera view is restricted. You cannot see the corner ends of the bumper or what is underneath the bumper. Its unique lens also makes objects appear closer or farther than they actually are.

Visually confirm that it is safe to drive before backing up. Certain conditions (such as weather, lighting, and high temperatures) may also restrict the rear view. Do not rely on the rearview display which does not give you all information about conditions at the back of your vehicle.

If the camera lens is covered with dirt, or moisture, use a soft, moist cloth to keep the lens clean and free of debris.

Rearview Camera Display Area

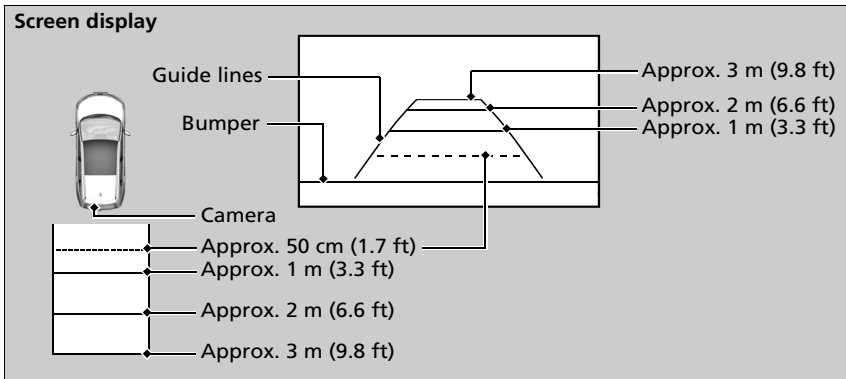

About Your Multi-View Rear Camera

Models without audio system

The i-multi-information display can display your vehicle's rear view. The display automatically changes to the rear view when the gear position is changed to **R**.

Models with two displays

The audio/information screen can display your vehicle's rear view. The display automatically changes to the rear view when the gear position is changed to **R**.

About Your Multi-View Rear Camera

The rear camera view is restricted. You cannot see the corner ends of the bumper or what is underneath the bumper. Its unique lens also makes objects appear closer or farther than they actually are.

Visually confirm that it is safe to drive before backing up. Certain conditions, such as weather, lighting, and high temperatures, may also restrict the rear view. Do not rely on the rearview display which does not give you all information about conditions at the back of your vehicle.

If the camera lens is covered with dirt or moisture, use a soft, moist cloth to keep the lens clean and free of debris.

* Not available on all models

Multi-View Rear Camera Display Area

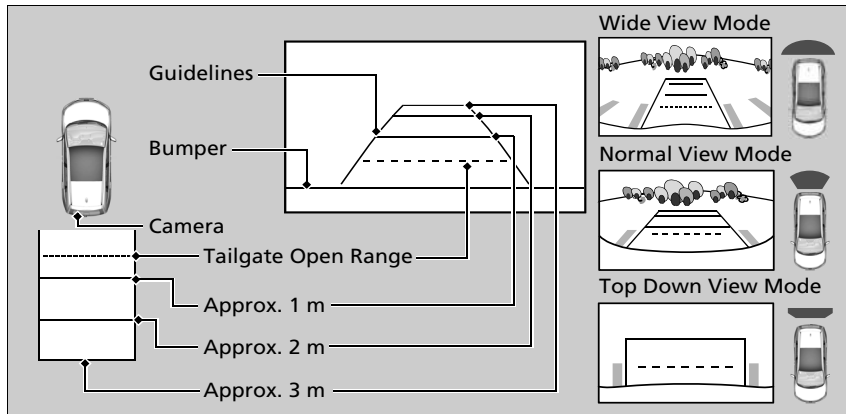

About Your Multi-View Rear Camera

You can change the **Fixed Guideline** and **Dynamic Guideline** settings.

▶ **Customized Features*** P. 323

Models with two displays

Fixed Guideline

On: Guidelines appear when you change the gear position to **R**.

Off: Guidelines do not appear.

Dynamic Guideline

On: Guidelines move according to the steering wheel direction.

Off: Guidelines do not move.

Models with two displays

You can view three different camera angles on the rearview display.
Touch the appropriate icon to switch the angle.

: Wide view

: Normal view

: Top down view

If the last used viewing mode is Wide or Normal, the same mode is selected the next time you change the gear position to **R**. If Top View is last used before you turned off the engine, Wide mode is selected next time you turn the ignition switch to ON **II***1 and change the gear position to **R**.

*1: Models with the smart entry system have an **ENGINE START/STOP** button instead of an ignition switch.

Petrol models

Fuel Information

■ Fuel recommendation

Unleaded premium petrol, research octane number 95 or higher

Your vehicle is designed to operate on premium unleaded petrol with a research octane of 95 or higher. If this octane grade is unavailable, regular unleaded petrol with a research octane of 91 or higher may be used temporarily.

The use of regular unleaded petrol can cause metallic knocking noises in the engine and will result in decreased engine performance. The long-term use of regular-grade petrol can lead to engine damage.

■ Fuel tank capacity: 58 litres

⌘ Fuel Information

NOTICE

Use of petrol that contains lead presents the following risks:

- Damage to the exhaust system including the catalytic converter
- Damage to the engine and fuel system
- Detrimental effects on the engine and other systems

Diesel models

Fuel Information

■ Fuel recommendation

**EN 590 standard diesel fuel*¹
Diesel fuel with sulfur less 50ppm only*²**

*1: Except Ukraine models

*2: Ukraine models

Select the proper fuel of clean and good quality according to the regional and climate condition. Use of improper fuel can reduce engine power.

■ Fuel tank capacity: 58 litres

⌘ Fuel Information

NOTICE

Serious damage may occur if petrol is used in diesel engines.

Your vehicle is not designed to use Biodiesel (pure or high concentration more than specified by EN590). Consult a dealer for more information.

Petrol models

How to Refuel

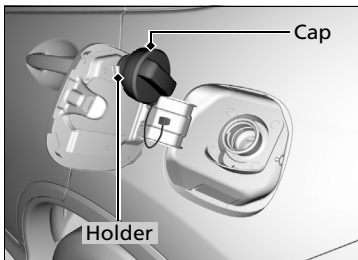
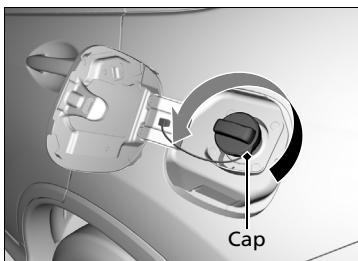
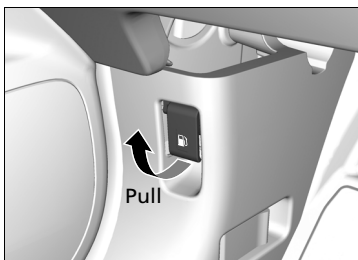

1. Stop your vehicle with the service station pump on the left side of the vehicle in the rear.
2. Turn off the engine.
3. Pull on the fuel fill door release handle under the lower left/right corner of the dashboard.
 - ▶ The fuel fill door opens.
4. Remove the fuel fill cap slowly. If you hear a release of air, wait until this stops, then turn the knob slowly to open the fuel fill cap.
5. Place the fuel fill cap in the holder.
6. Insert the fuel filler nozzle fully.
 - ▶ When the tank is full, the filler nozzle will click off automatically. This leaves space in the fuel tank in case the fuel expands with a change in the temperature.
7. After filling, replace the fuel fill cap, tightening it until you hear it click at least once.
 - ▶ Shut the fuel fill door by hand.

How to Refuel

⚠ WARNING

Petrol is highly flammable and explosive. You can be burned or seriously injured when handling fuel.

- Stop the engine, and keep heat, sparks, and flame away.
- Handle fuel only outdoors.
- Wipe up spills immediately.

Do not continue to add fuel after the nozzle has automatically stopped. Additional fuel can exceed the full tank capacity.

The filler nozzle automatically stops to leave space in the fuel tank so that fuel does not overflow as a result of changes in air temperature.

Diesel models

How to Refuel

Your fuel tank is not equipped with a fuel filler cap. You can insert the diesel fuel filler nozzle directly into the fuel filler neck. The tank seals itself again when you pull out the filler nozzle.

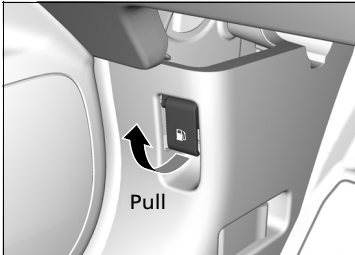

1. Stop your vehicle with the service station pump on the left side of the vehicle in the rear.
2. Turn off the engine.
3. Pull on the fuel fill door release handle under the lower left/right corner of the dashboard.
 - ▶ The fuel fill door opens.

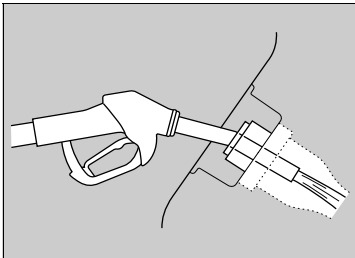

4. Insert the filler nozzle fully.
 - ▶ Keep the filler nozzle level.
 - ▶ When the tank is full, the filler nozzle will click off automatically.
 - ▶ After filling, wait about 10 seconds before removing the filler nozzle.
5. Shut the fuel fill door by hand.

How to Refuel

⚠ WARNING

Fuel is highly flammable and explosive. You can be burned or seriously injured when handling fuel.

- Stop the engine, and keep heat, sparks, and flame away.
- Handle fuel only outdoors.
- Wipe up spills immediately.

Only a service station diesel fuel filler nozzle can be used.

The filler nozzle automatically stops to leave space in the fuel tank so that fuel does not overflow as a result of changes in air temperature.

Do not continue to add fuel after the nozzle has automatically stopped. Additional fuel can exceed the full tank capacity.

If you have to refuel your vehicle from a portable container, use the funnel provided with the vehicle.

▶ **Refueling From a Portable Fuel Container**
P. 650

Improving Fuel Economy and Reducing CO₂ Emissions

Achieving fuel economy and reducing CO₂ emissions is dependent on several factors, including driving conditions, load weight, idling time, driving habits, and vehicle condition. Depending on these and other factors, you may not achieve the rated fuel economy of this vehicle.

Maintenance and Fuel Economy

You can optimize your fuel economy with proper maintenance of your vehicle. Always maintain your vehicle according to the service reminder symbols displayed on the multi-information display. On vehicles without service reminder system, follow the maintenance schedule in the Service Book that came with your vehicle. On vehicles without Service Book, follow the maintenance schedule in this owners manual. If necessary, consult your warranty booklet.

➤ Maintenance Schedule* P. 536

- Use engine oil with the viscosity recommended by the ACEA or API Certification Seal.
- Maintain the specified tyre pressure.
- Do not load the vehicle with excess luggage.
- Keep your vehicle clean. A buildup of snow or mud on your vehicle's underside adds weight and increases wind resistance.

➤ Improving Fuel Economy and Reducing CO₂ Emissions

Direct calculation is the recommended method to determine actual fuel consumed while driving.

100	×	Litres of fuel	÷	Kilometres driven	=	L per 100 km
Miles driven	÷	Gallons of fuel	=	Miles per Gallon		

Maintenance

This chapter discusses basic maintenance.



Before Performing Maintenance		
Service Reminder System	531	
Maintenance Schedule*	536	
Maintenance Record (On Vehicles without Service Book)	543	
Maintenance Under the Bonnet	544	
Opening the Bonnet	546	
Petrol models		
Recommended Engine Oil	547	
Diesel models		
Recommended Engine Oil	549	
Oil Check	550	
Adding Engine Oil	552	
Petrol models		
Engine Coolant	553	
Diesel models		
Engine Coolant	556	
Transmission Fluid	558	
Brake/Clutch Fluid	560	
Refilling Window Washer Fluid	561	
Fuel Filter	561	
Diesel Particulate Filter (DPF)		
Regeneration*	562	
Replacing Light Bulbs	564	
Checking and Maintaining Wiper Blades ..	576	
Checking and Maintaining Tyres		
Checking Tyres	580	
Wear Indicators	581	
Tyre Service Life	581	
Tyre and Wheel Replacement	582	
Tyre Rotation	583	
Snow Traction Devices	584	
Battery	585	
Remote Transmitter Care		
Replacing the Button Battery	589	
Climate Control System* Maintenance ..	591	
Cleaning	594	
Accessories and Modifications	599	

* Not available on all models

Inspection and Maintenance

For your safety, perform all listed inspections and maintenance to keep your vehicle in good condition. If you become aware of any abnormality (noise, smell, insufficient brake fluid, oil residue on the ground, etc.), have your vehicle inspected by a dealer. Refer to the Service Book that came with your vehicle/maintenance schedule in this owner's manual for detailed maintenance and inspection information.

➤ **Maintenance Schedule*** P. 536

Types of Inspection and Maintenance

■ Daily inspections

Perform inspections before long distance trips, when washing the vehicle, or when refueling.

■ Periodic inspections

- Check the automatic transmission fluid* level monthly.
 - **Automatic Transmission Fluid** P. 558
- Check the brake fluid level monthly.
 - **Brake/Clutch Fluid** P. 560
- Check the tyre pressure monthly. Examine the tread for wear and foreign objects.
 - **Checking and Maintaining Tyres** P. 580
- Check the operation of the exterior lights monthly.
 - **Replacing Light Bulbs** P. 564
- Check the condition of the wiper blades at least every six months.
 - **Checking and Maintaining Wiper Blades** P. 576

Safety When Performing Maintenance

Some of the most important safety precautions are given here. However, we cannot warn you of every conceivable hazard that can arise in performing maintenance. Only you can decide whether or not you should perform a given task.

Maintenance Safety

- To reduce the possibility of fire or explosion, keep cigarettes, sparks, and flames away from the battery and all fuel related parts.
- To clean parts, use a commercially available degreaser or parts cleaner, not petrol.
- Never leave rags, towels, or other flammable objects under the bonnet.
 - ▶ Heat from the engine and exhaust can ignite them, causing a fire.
- Wear eye protection and protective clothing when working with the battery or compressed air.
- Engine exhaust contains carbon monoxide, which is poisonous and can kill you.
 - ▶ Only operate the engine if there is sufficient ventilation.

Vehicle Safety

- The vehicle must be in a stationary condition.
 - ▶ Make sure your vehicle is parked on level ground, the parking brake is set, and the engine is off.
- Be aware that hot parts can burn you.
 - ▶ Make sure to let the engine and exhaust system cool thoroughly before touching vehicle parts.
- Be aware that moving parts can injure you.
 - ▶ Do not start the engine unless instructed, and keep your hands and limbs away from moving parts.

Models with Auto Idle Stop

- ▶ Do not open the bonnet while Auto Idle Stop function is activated.

⚠ Safety When Performing Maintenance

⚠ WARNING

Improperly maintaining this vehicle or failing to correct a problem before driving can cause a crash in which you can be seriously hurt or killed.

Always follow the inspection and maintenance recommendations and schedules in this owner's manual/Service Book.

⚠ WARNING

Failure to properly follow maintenance instructions and precautions can cause you to be seriously hurt or killed.

Always follow the procedures and precautions in this owner's manual.

Parts and Fluids Used in Maintenance Service

The use of Honda genuine parts and fluids is recommended when maintaining and servicing your vehicle. Honda genuine parts are manufactured according to the same high quality standards used in Honda vehicles.

About Your Maintenance Service

If the service reminder system is available in your vehicle, you are informed by the multi-information display when your vehicle's maintenance services are due. Refer to the Service Book that came with your vehicle for an explanation of the service item codes that appear on the display.

➤ **Service Reminder System** P. 531

If the service reminder system is not available, follow the maintenance schedules in the Service Book that came with your vehicle.

If your vehicle is without the Service Book, follow the maintenance schedule in this owner's manual.

➤ **Maintenance Schedule*** P. 536

▶▶ Parts and Fluids Used in Maintenance Service

Diesel models

NOTICE

Do not press the engine cover forcibly. This may damage the engine cover and component parts.

▶▶ About Your Maintenance Service

If you are planning to take your vehicle outside the service reminder system applied countries, consult a dealer on how to record your service reminder information and schedule your maintenance service under the conditions of that country.

Service Reminder System

Provides information of which service items are to be performed. Service items are represented by a code and icon. The system tells you when to take your vehicle to a dealer by distance or days remaining.

When the next maintenance service timing is near, coming or passed, a warning icon will also appear on the multi-information display every time you turn the ignition switch to ON ^{*1}.

*1: Models with the keyless access system have an **ENGINE START/STOP** button instead of an ignition switch.

Continued

Service Reminder System

You can choose to have a corresponding warning message displayed with the warning icon on the multi-information display.

The maintenance schedule may not display correct information if you disconnect or remove the battery for an extended period. If this occurs, see a dealer.

■ Displaying the Service Reminder Information

1. Turn the ignition switch to ON *1.
2. Press the **SEL/RESET** button repeatedly until the maintenance item(s) appears on the multi-information display.

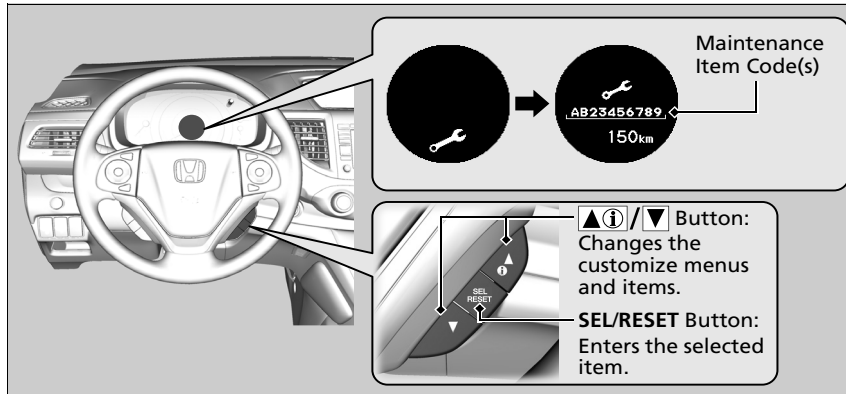

The system message indicator (ⓘ) comes on along with the service reminder information.

▣ Displaying the Service Reminder Information



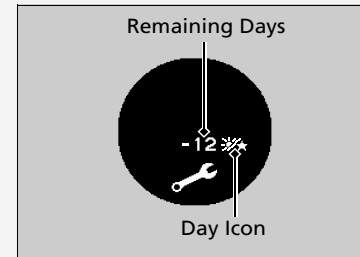

Based on engine operating conditions and engine oil conditions, the system calculates the remaining distance or days before the next service is to be performed.

If the system calculates that the indicated time for the next maintenance service comes earlier than the indicated distance, the service reminder information display changes to show the remaining days.



*1: Models with the keyless access system have an **ENGINE START/STOP** button instead of an ignition switch.

Warning Icons and Service Reminder Information on the Multi-Information Display

Warning Icon (Amber)	Explanation	Information
<p>SERVICE DUE SOON</p> 	<p>One or more of the service items are required in less than 30 days. The remaining distance is estimated based on your driving conditions.</p>	<p>The remaining distance will be counted down per 10 kilometres/miles.</p> <p>The remaining days will be counted down per day.</p>
<p>SERVICE DUE NOW</p> 	<p>One or more of the service items are required in less than 10 days. The remaining distance is estimated based on your driving conditions.</p>	<p>Have the indicated service performed as soon as possible.</p>
<p>SERVICE OVER DUE</p>  	<p>The indicated maintenance service is still not done after the remaining distance or time reaches 0.</p>	<p>Your vehicle has passed the service required point. Immediately have the service performed and make sure to reset the service reminder.</p>

■ Service Reminder Items

Service items displayed on the multi-information display are in code and icon. For an explanation of the service reminder codes and icons, refer to the Service Book that came with your vehicle.

■ Availability of the Service Reminder System

Even if the service reminder information appears on the multi-information display while pressing the  (display/information) button, this system is not available in some countries. Refer to Service Book that came with your vehicle, or ask a dealer if you can use the service reminder system.

⌘ Availability of the Service Reminder System

If you are planning to take your vehicle outside the service reminder system applied countries, consult a dealer on how to record your service reminder information and schedule your maintenance service under the conditions of that country.

Resetting the Display

Reset the service reminder information display if you have performed the maintenance service.

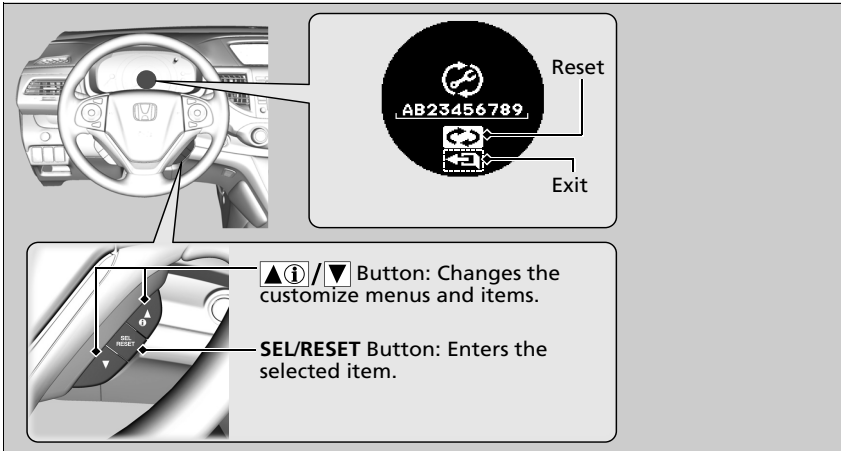

1. Turn the ignition switch to ON *1.
2. Display the engine oil life by repeatedly pressing the **SEL/RESET** button.
3. Press and hold the **SEL/RESET** button for 10 seconds or more.
 - ▶ The service reminder reset mode is displayed on the multi-information display.
4. Select with the **SEL/RESET** button.

*1: Models with the keyless access system have an **ENGINE START/STOP** button instead of an ignition switch.

Resetting the Display

NOTICE

Failure to reset the service reminder information after a maintenance service results in the system showing incorrect maintenance intervals, which can lead to serious mechanical problems.

The dealer will reset the service reminder information display after completing the required maintenance service. If someone other than a dealer performs maintenance service, reset the service reminder information display yourself.

Maintenance Schedule*

If your vehicle comes with the service book, the maintenance schedule for your vehicle is available in the book. For vehicles without the Service Book, refer to the following maintenance schedules.

The maintenance schedule outlines the minimum required maintenance that you should perform to ensure the troublefree operation of your vehicle. Due to regional and climatic differences, some additional servicing may be required. Please consult your warranty booklet for a more detailed description.

Maintenance work should be performed by properly trained and equipped technicians. Your authorized dealer meets all of these requirements.

Petrol models

Except European models

Service at the indicated distance or time - whichever comes first.	km X 1,000	20	40	60	80	100	120	140	160	180	200
	miles X 1,000	12.5	25.0	37.5	50.0	62.5	75.0	87.5	100.0	112.5	125.0
	months	12	24	36	48	60	72	84	96	108	120
Replace engine oil* ¹	Normal	Every 10,000 km (6,250 miles) or 1 year									
	Severe	Every 5,000 km (3,125 miles) or 6 months									
Replace engine oil filter* ¹	Normal	•	•	•	•	•	•	•	•	•	•
	Severe	Every 10,000 km (6,250 miles) or 6 months									
Replace air cleaner element	Every 30,000 km (18,750 miles)										
Inspect valve clearance	Every 40,000 km (25,000 miles)										
Replace fuel filter* ²				•					•		
Replace spark plugs	Every 100,000 km (62,500 miles)										
Inspect drive belts		•		•		•		•			•
Inspect idle speed						•					
Replace engine coolant	At 200,000 km (120,000 miles) or 10 years, thereafter every 100,000 km (60,000 miles) or 5 years										
Replace transmission fluid	MT	Normal					•				
		Severe			•		•			•	
	AT	Normal					•				•
		Severe			•		•		•		•

*1: Only severe schedule is required in some countries: refer to the local warranty booklet.

*2: Refer to page 561 for replacement information under severe driving conditions.

Service at the indicated distance or time - whichever comes first.	km X 1,000	20	40	60	80	100	120	140	160	180	200
	miles X 1,000	12.5	25.0	37.5	50.0	62.5	75.0	87.5	100.0	112.5	125.0
	months	12	24	36	48	60	72	84	96	108	120
Replace rear differential fluid	AWD	At 40,000 km (25,000 miles) or 1 year, thereafter every 80,000 km (50,000 miles) or 4 years									
Inspect front and rear brakes		Every 10,000 km (6,250 miles) or 6 months									
Replace brake fluid		Every 3 years									
Check parking brake adjustment		•	•		•		•		•		•
Replace dust and pollen filter*		•	•	•	•	•	•	•	•	•	•
Rotate tyres (Check tyre inflation and condition at least once per month)		Every 10,000 km (6,250 miles)									
Visually inspect the following items:											
Tie rod ends, steering gearbox, and boots		Every 10,000 km (6,250 miles) or 6 months									
Suspension components		Every 10,000 km (6,250 miles) or 6 months									
Driveshaft boots		Every 10,000 km (6,250 miles) or 6 months									
Brake hoses and lines (including ABS)											
All fluid levels and condition of fluid		•	•	•	•	•	•	•	•	•	•
Exhaust system											
Fuel lines and connections											

If you drive your vehicle under severe conditions, you must have the following items served to the maintenance schedule indicated as Severe.

Items	Condition
Engine oil and filter	A, B, C, D and E
Transmission fluid	B, D

▣ Maintenance Schedule*

- The condition is considered as severe when you drive:
- A. Less than 8 km (5 miles), or less than 16 km (10 miles) in freezing temperatures per trip.
 - B. In extremely hot temperature above 35°C.
 - C. With extensive idling or long periods of stop-and-go.
 - D. With a trailer towing, or loaded roof rack, or in mountains.
 - E. On muddy, dusty or de-iced roads.

* Not available on all models

Continued

Diesel models

Except European models

Service at the indicated distance or time - whichever comes first.	km X 1,000	20	40	60	80	100	120	140	160	180	200	
	miles X 1,000	12.5	25.0	37.5	50.0	62.5	75.0	87.5	100.0	112.5	125.0	
	months	12	24	36	48	60	72	84	96	108	120	
Replace engine oil and oil filter	Normal	Every 10,000 km (6,250 miles) or 1 year										
	Severe	Every 5,000 km (3,125 miles) or 6 months										
Replace air cleaner element	Every 30,000 km (18,750 miles)											
Replace fuel filter	Every 30,000 km (18,750 miles)											
Inspect drive belts			•		•		•		•		•	
Replace engine coolant												
Replace transmission fluid	MT	Normal	Every 120,000 km (75,000 miles) or 6 years									
		Severe			•			•			•	
	AT	Normal						•				•
		Severe				•			•			•
Replace transfer fluid*	AT	Normal					•				•	
		Severe				•		•			•	
Replace rear differential fluid*												
Inspect front and rear brakes	Every 10,000 km (6,250 miles) or 6 months											
Replace brake fluid	Every 3 years											

Service at the indicated distance or time - whichever comes first.	km X 1,000	20	40	60	80	100	120	140	160	180	200
	miles X 1,000	12.5	25.0	37.5	50.0	62.5	75.0	87.5	100.0	112.5	125.0
	months	12	24	36	48	60	72	84	96	108	120
Check parking brake adjustment		•	•		•		•		•		•
Replace dust and pollen filter*		•	•	•	•	•	•	•	•	•	•
Check expiry date for TRK bottle*		•	•	•	•	•	•	•	•	•	•
Rotate tyres (Check tyre inflation and condition at least once per month)		Every 10,000 km (6,250 miles)									
Visually inspect the following items:											
Tie rod ends, steering gearbox, and boots		Every 10,000 km (6,250 miles) or 6 months									
Suspension components											
Driveshaft boots											
Brake hoses and lines (including ABS)											
All fluid levels and condition of fluid		•	•	•	•	•	•	•	•	•	•
Exhaust system											
Fuel lines and connections											

* Not available on all models

If you drive your vehicle under severe conditions, you must have the following items served to the maintenance schedule indicated as Severe.

Items	Condition
Engine oil and filter	A, B, C, D and E
Transfer fluid*	B, D
Transmission fluid	B, D

✎ Maintenance Schedule*

- The condition is considered as severe when you drive:
- A. Less than 8 km (5 miles), or less than 16 km (10 miles) in freezing temperatures per trip.
 - B. In extremely hot temperature above 35°C.
 - C. With extensive idling or long periods of stop-and-go.
 - D. With a trailer towing, or loaded roof rack, or in mountains.
 - E. On muddy, dusty or de-iced roads.

Maintenance Record (On Vehicles without Service Book)

Except European models

Have your servicing dealer record all required maintenance below. Keep receipts for all work done on your vehicle.

Km (Mi.) or Month	Date	Sign or Stamp
20,000 km 12,500 Mi. (or 12 Mo.)		
40,000 km 25,000 Mi. (or 24 Mo.)		
60,000 km 37,500 Mi. (or 36 Mo.)		
80,000 km 50,000 Mi. (or 48 Mo.)		
100,000 km 62,500 Mi. (or 60 Mo.)		
120,000 km 75,000 Mi. (or 72 Mo.)		
140,000 km 87,500 Mi. (or 84 Mo.)		
160,000 km 100,000 Mi. (or 96 Mo.)		
180,000 km 112,500 Mi. (or 108 Mo.)		
200,000 km 125,000 Mi. (or 120 Mo.)		

Maintenance Items Under the Bonnet

Petrol models

Right-hand drive models

Brake Fluid
(Black Cap)

Manual transmission with
right-hand drive models

Clutch Fluid
(Light Grey Cap)

Washer Fluid
(Blue Cap)

Engine Oil Fill Cap

Engine Coolant
Reserve Tank

Engine Oil Dipstick
(Orange)

Left-hand drive models

Brake Fluid
(Black Cap)

Manual transmission with
left-hand drive models

Clutch Fluid
(Light Grey Cap)

Battery

Radiator Cap

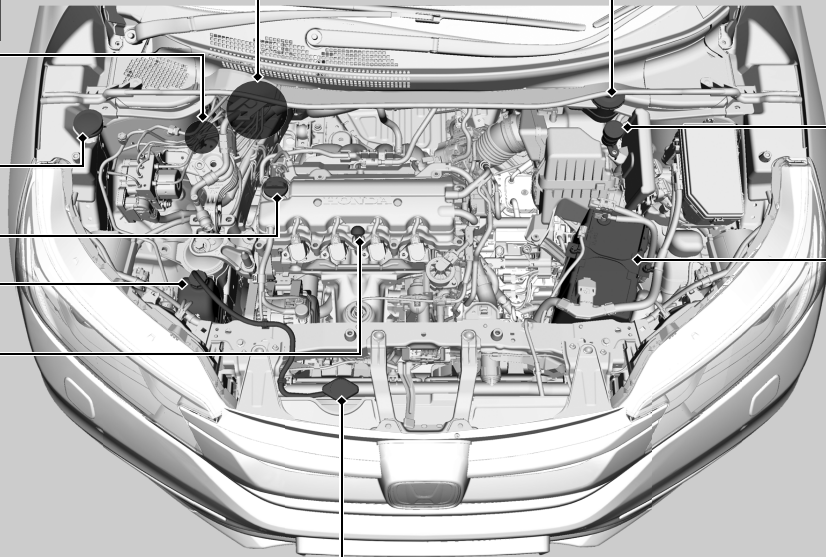

Diesel models

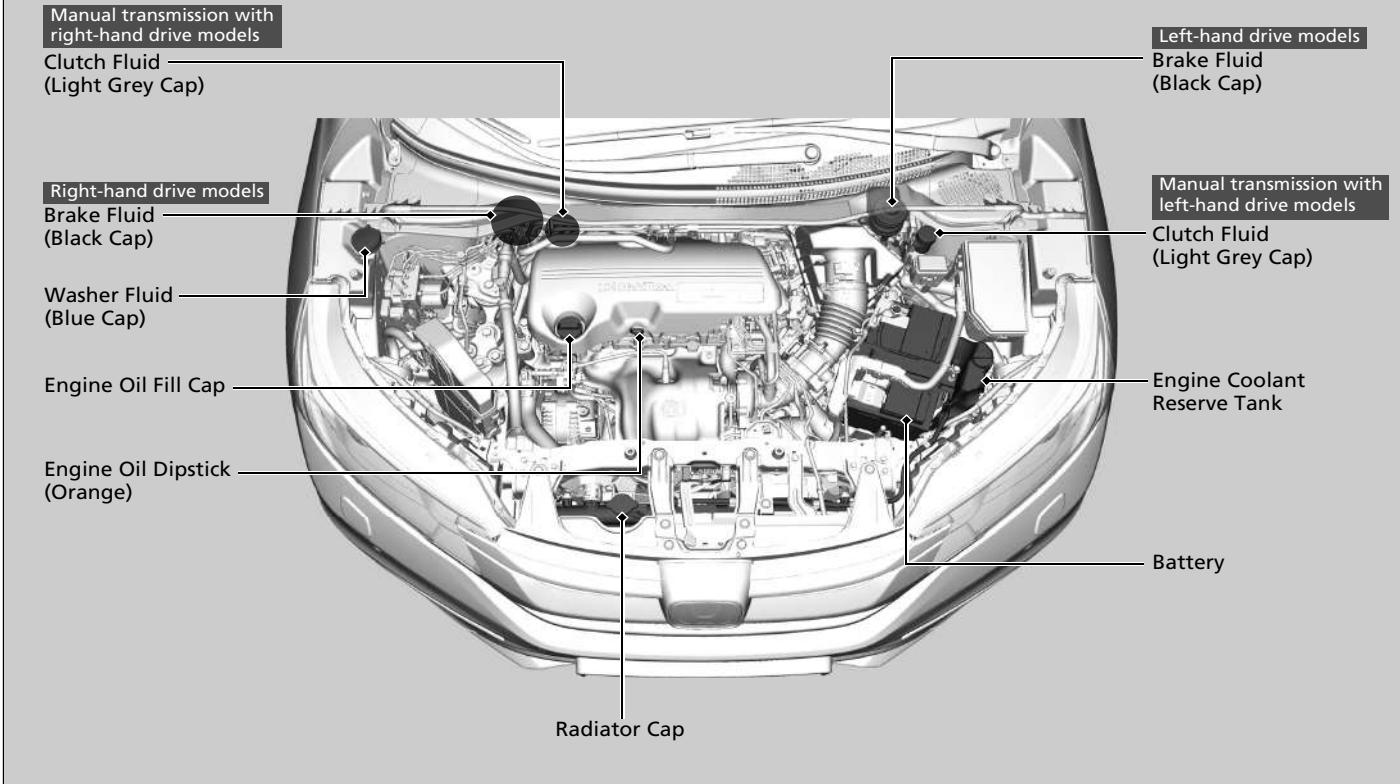

Opening the Bonnet

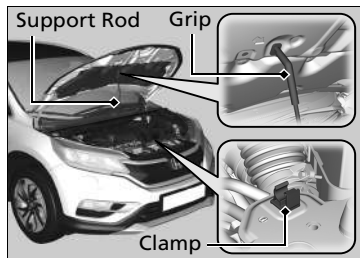
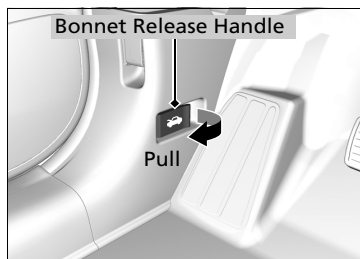

1. Park the vehicle on a level surface, and set the parking brake.
2. Pull on the bonnet release handle under the driver side's lower outer corner of the dashboard.
 - The bonnet will pop up slightly.
3. Push up the bonnet latch lever in the centre of the bonnet to release the lock mechanism, and open the bonnet.

4. Remove the support rod from the clamp using the grip. Mount the support rod in the bonnet.

When closing, remove the support rod, and stow it in the clamp, then gently lower the bonnet. Remove your hand at a height of approximately 30 cm (12 inches) and let the bonnet close.

►► Opening the Bonnet

NOTICE

Do not open the bonnet when the wiper arms are raised. The bonnet will strike the wipers, and may damage either the bonnet or the wipers.

Diesel models

NOTICE

Do not press the engine cover forcibly. This may damage the engine cover and component parts.

When closing the bonnet, check that the bonnet is securely latched.

If the bonnet latch lever moves stiffly, or if you can open the bonnet without lifting the lever, the latch mechanism should be cleaned and lubricated.

Models with Auto Idle Stop

Do not open the bonnet while Auto Idle Stop function is activated.

Petrol models

Recommended Engine Oil

Oil is a major contributor to your engine's performance and longevity. If you drive the vehicle with insufficient or deteriorated oil, the engine may fail or be damaged.

European models with service reminder system

- **Honda Green Oil**
- **ACEA A3/B3**
- **ACEA A5/B5**

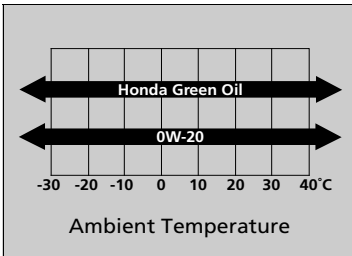

Use a Honda Green oil or another commercial engine oil of suitable viscosity for the ambient temperature as shown.

Honda Green oil is formulated to improve fuel economy.

If Honda Green oil or 0W-20 oil is not available, use 5W-30 or 0W-30 oil.

Recommended Engine Oil

Engine Oil Additives

Your vehicle does not require oil additives. In fact, they may adversely affect the engine performance and durability.

ACEA viscosity oil is available for European models only.

Continued

European models without service reminder system

- **Genuine Honda Motor Oil**
- **ACEA A1/B1**
- **ACEA A3/B3**
- **ACEA A5/B5**

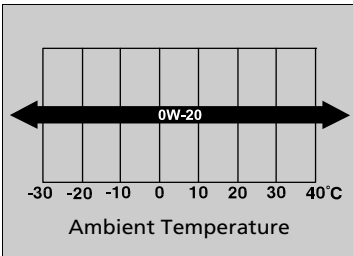

Use a Genuine Honda Motor oil or another commercial engine oil of suitable viscosity for the ambient temperature as shown.

If 0W-20 is not available, use 5W-30 or 0W-30.

Except European models

- **Genuine Honda Motor Oil**
- **API service SM or higher grade fuel-efficient oil**

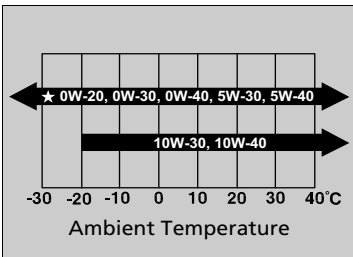

Use a Genuine Honda Motor oil or another commercial engine oil of suitable SAE viscosity for the ambient temperature as shown.

0W-20 oil is formulated to improve fuel economy.

Diesel models

Recommended Engine Oil

Oil is a major contributor to your engine's performance and longevity. If you drive the vehicle with insufficient or deteriorated oil, the engine may fail or be damaged.

- **Honda Diesel Oil #1.0**
- **ACEA C2/C3**

European and Ukraine models

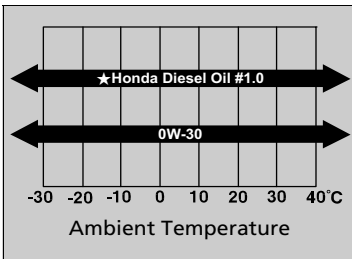

Except European and Ukraine models

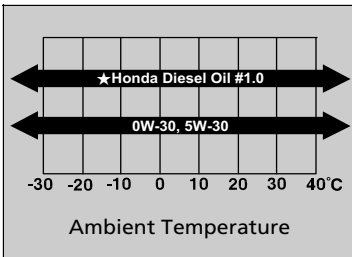

Use a commercial engine oil of suitable viscosity for the ambient temperature as shown.

Honda Diesel Oil #1.0 oil is formulated to improve fuel economy.

European models with 2WD

If Honda Diesel Oil #1.0 or 0W-30 is not available, use 5W-30.

Use a commercial engine oil of suitable viscosity for the ambient temperature as shown.

Honda Diesel Oil #1.0 oil is formulated to improve fuel economy.

▣ Recommended Engine Oil

Engine Oil Additives

Your vehicle does not require oil additives. In fact, they may adversely affect the engine performance and durability.

Oil Check

We recommend that you check the engine oil level every time you refuel.

Park the vehicle on level ground.

Wait approximately three minutes after turning the engine off before you check the oil.

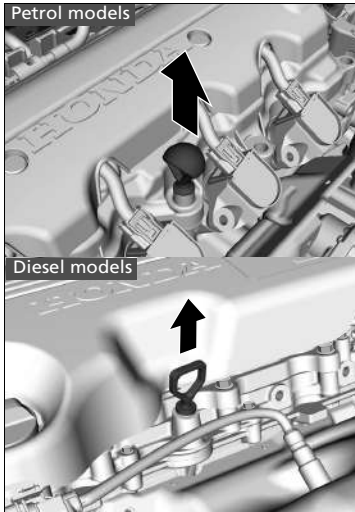

1. Remove the dipstick (orange).
2. Wipe the dipstick with a clean cloth or paper towel.
3. Insert the dipstick back all the way into its hole.

Oil Check

If the oil level is near or below the lower mark, slowly add oil, being careful not to overfill.

The amount of oil consumed depends on how the vehicle is driven and the climatic and road conditions encountered. The rate of oil consumption can be up to 1 litre per 1,000 km/625 miles. Consumption is likely to be higher when the engine is new.

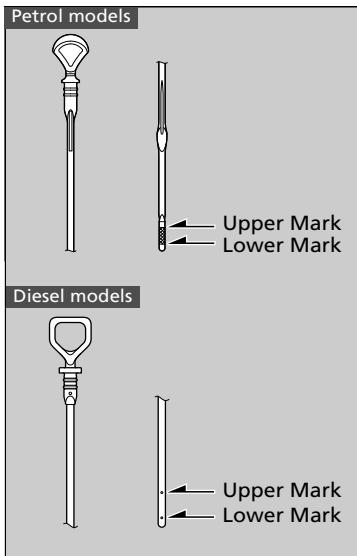

4. Remove the dipstick again, and check the level. It should be between the upper and lower marks. Add oil if necessary.

Adding Engine Oil

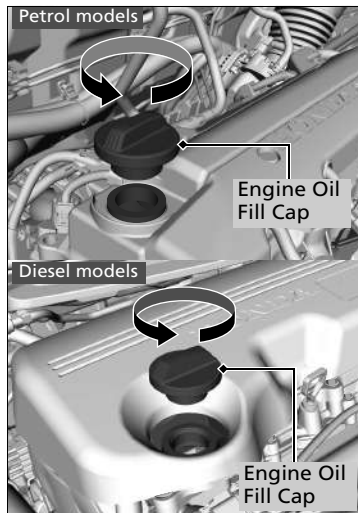

1. Unscrew and remove the engine oil fill cap.
2. Add oil slowly.
3. Reinstall the engine oil fill cap, and tighten it securely.
4. Wait for three minutes and recheck the engine oil dipstick.

► Adding Engine Oil

NOTICE

Do not fill the engine oil above the upper limit mark. Overfilling the engine oil can result in leaks and engine damage.

If any oil spills, wipe it up immediately. Spilled oil may damage the engine compartment components.

Petrol models

Engine Coolant

Specified coolant: Honda All Season Antifreeze/Coolant Type 2

This coolant is premixed with 50% antifreeze and 50% water. Do not add any straight antifreeze or water.

We recommend you check the engine coolant level every time you refuel. Check the reserve tank first. If it is completely empty, also check the coolant level in the radiator. Add the engine coolant accordingly.

Engine Coolant

If Honda antifreeze/coolant is not available, you may use another major brand non-silicate coolant as a temporary replacement. Check that it is a high quality coolant recommended for aluminium engines. Continued use of any non-Honda coolant can result in corrosion, causing the cooling system to malfunction or fail. Have the cooling system flushed and refilled with Honda antifreeze/coolant as soon as possible.

Do not add rust inhibitors or other additives to your vehicle's coolant system. They may not be compatible with the coolant or with the engine components.

Continued

■ Reserve Tank

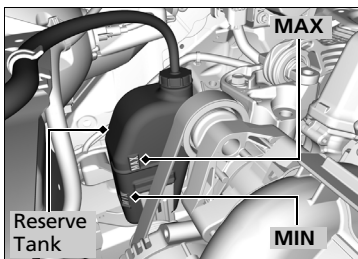

1. Check the amount of coolant in the reserve tank.

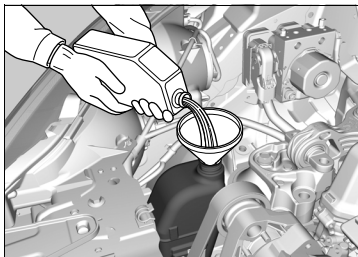

2. If the coolant level is below the **MIN** mark, add the specified coolant until it reaches the **MAX** mark.

3. Inspect the cooling system for leaks.

Radiator

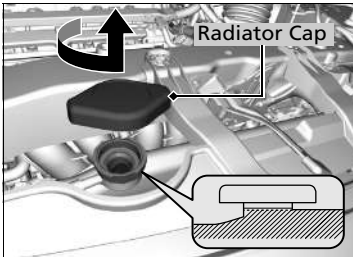

1. **Make sure the engine and radiator are cool.**
2. Turn the radiator cap anticlockwise and relieve any pressure in the coolant system. Do not push the cap down when turning.
3. Push down and turn the radiator cap anticlockwise to remove it.
4. The coolant level should be up to the base of the filler neck. Add coolant if it is low.
5. Put the radiator cap back on, and tighten it fully.
6. Pour coolant into the reserve tank until it reaches the **MAX** mark. Put the cap back on the reserve tank.

Radiator

⚠ WARNING

Removing the radiator cap while the engine is hot can cause the coolant to spray out, seriously scalding you.

Always let the engine and radiator cool down before removing the radiator cap.

NOTICE

Pour the fluid slowly and carefully so you do not spill any. Clean up any spills immediately; they can damage components in the engine compartment.

Diesel models

Engine Coolant

Specified coolant: Honda All Season Antifreeze/Coolant Type 2

This coolant is premixed with 50% antifreeze and 50% water. Do not add any straight antifreeze or water.

We recommend you check the engine coolant level every time you refuel. Check the reserve tank. Add the engine coolant accordingly.

Reserve Tank

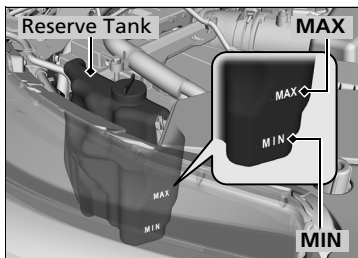

1. Check the amount of coolant in the reserve tank.

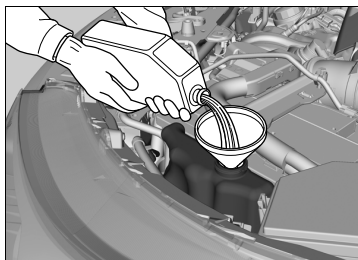

2. If the coolant level is below the **MIN** mark, add the specified coolant until it reaches the **MAX** mark.
3. Inspect the cooling system for leaks.

Engine Coolant

If Honda antifreeze/coolant is not available, you may use another major brand non-silicate coolant as a temporary replacement. Check that it is a high quality coolant recommended for aluminium engines. Continued use of any non-Honda coolant can result in corrosion, causing the cooling system to malfunction or fail. Have the cooling system flushed and refilled with Honda antifreeze/coolant as soon as possible.

Do not add rust inhibitors or other additives to your vehicle's coolant system. They may not be compatible with the coolant or with the engine components.

Radiator

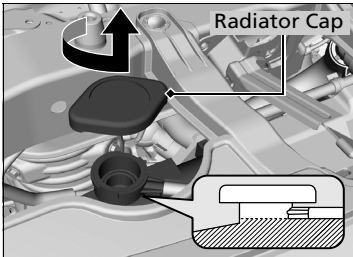

1. **Make sure the engine and radiator are cool.**
2. Turn the radiator tank cap 1/8 turn anticlockwise and relieve any pressure in the coolant system.
3. Push down and turn the radiator cap anticlockwise to remove it.
4. The coolant level should be up to the base of the filler neck. Add coolant if it is low.
5. Put the radiator cap back on, and tighten it fully.
6. Pour coolant into the reserve tank until it reaches the **MAX** mark. Put the cap back on the reserve tank.

Radiator

⚠ WARNING

Removing the radiator cap while the engine is hot can cause the coolant to spray out, seriously scalding you.

Always let the engine and radiator cool down before removing the radiator cap.

NOTICE

Pour the fluid slowly and carefully so you do not spill any. Clean up any spills immediately; they can damage components in the engine compartment.

Transmission Fluid

Automatic transmission models

Automatic Transmission Fluid

Petrol models

Specified fluid: Honda ATF DW-1 (automatic transmission fluid)

Check the fluid level when the engine is at normal operating temperature.

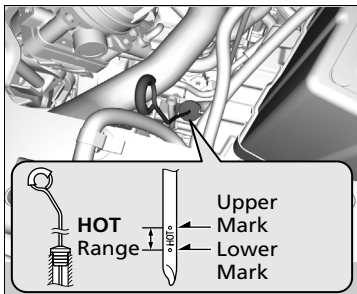

1. Park on level ground, and start the engine.
2. Wait until the radiator fan starts and then turn off the engine.
 - Perform step 3 after waiting for about 60 seconds (less than 90 seconds).
3. Remove the dipstick (yellow loop) from the transmission and wipe it with a clean cloth.
4. Insert the dipstick all the way back into the transmission securely, as shown in the image.
5. Remove the dipstick and check the fluid level.
 - It should be between the upper and lower marks in the **HOT** range.
6. If the level is below the lower mark, add fluid into the dipstick hole to bring it to the level between the upper and lower marks, and have your vehicle checked by a dealer immediately.

►► Automatic Transmission Fluid

NOTICE

Pour the fluid slowly and carefully so you do not spill any. Clean up any spills immediately; they can damage components in the engine compartment.

NOTICE

Do not mix Honda ATF DW-1 with other transmission fluids.

Using a transmission fluid other than Honda ATF DW-1 may adversely affect the operation and durability of your vehicle's transmission, and damage the transmission.

Any damage caused by using a transmission fluid that is not equivalent to Honda ATF DW-1 is not covered by Honda's new vehicle warranty.

Diesel models**Specified fluid: Honda ATF-TYPE 3.0 (automatic transmission fluid)**

Have a dealer check the fluid level and replace if necessary.
Follow your vehicle's maintenance service timing of when to change automatic transmission fluid.

➤ **About Your Maintenance Service** P. 530

Manual transmission models**Manual Transmission Fluid****Specified fluid: Honda Manual Transmission Fluid (MTF)**

Follow your vehicle's maintenance service timing of when to change manual transmission fluid.

➤ **About Your Maintenance Service** P. 530

⌘ Manual Transmission Fluid

If Honda MTF is not available, you may use the API certified SAE 0W-20 or 5W-20 viscosity motor oil as a temporary measure.
Replace with MTF as soon as possible. Motor oil does not contain the proper additives for the transmission and continued use can cause decreased shifting performance and lead to transmission damage.

Brake/Clutch Fluid

Specified fluid: Brake Fluid with DOT 3 or DOT 4

Use the same fluid for both the brakes and clutch.

■ Checking the Brake Fluid

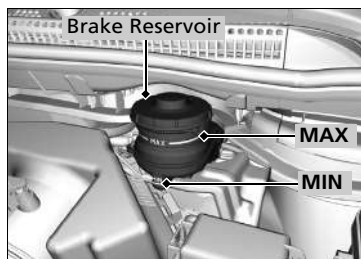

The fluid level should be between the **MIN** and **MAX** marks on the side of the reservoir.

Manual transmission models

■ Checking the Clutch Fluid

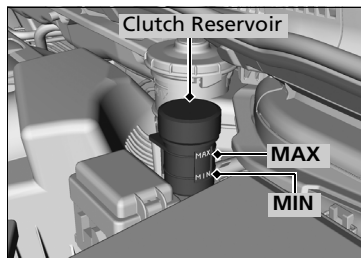

The fluid level should be between the **MIN** and **MAX** marks on the side of the reservoir.

►► Brake/Clutch Fluid

NOTICE

Brake fluid marked DOT 5 is not compatible with your vehicle's braking system and can cause extensive damage.

We recommend using a genuine product.

If the brake fluid level is at or below the **MIN** mark, have a dealer inspect the vehicle for leaks or worn brake pads as soon as possible.

►► Checking the Clutch Fluid

If the clutch fluid level is at or below the **MIN** mark, have a dealer inspect for leaks or an excessively worn clutch plate as soon as possible.

Refilling Window Washer Fluid

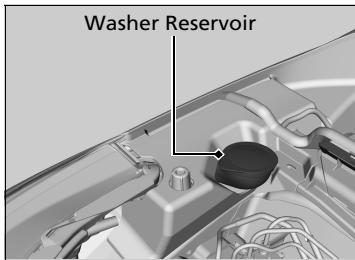

Models without washer level sensor

Check the amount of window washer fluid.
If the level is low, fill the washer reservoir.

Models with washer level sensor

If the washer fluid is low, a message appears on the multi-information display.
Pour the washer fluid carefully. Do not overflow the reservoir.

Fuel Filter

Replace fuel filter according to the time and distance recommendations in the maintenance schedule.

Petrol models

Except European models

It is recommended to replace the fuel filter every 40,000 km (25,000 miles), or 2 years, if you suspect the fuel you are using is contaminated. In a dusty environment, the filter may become clogged sooner.

Have a qualified technician change the fuel filter. Fuel in the system can spray out and create a hazard if all fuel line connections are not handled correctly.

▶▶ Refilling Window Washer Fluid

NOTICE

Do not use engine antifreeze or a vinegar/water solution in the windscreen washer reservoir. Antifreeze can damage your vehicle's paint. A vinegar/water solution can damage the windscreen washer pump. Use only commercially available windscreen washer fluid. Avoid prolonged use of hard water to prevent lime scale build up.

▶▶ Fuel Filter

Models with service reminder system

The fuel filter should be replaced according to the service reminder indication.

Diesel Particulate Filter (DPF)

Collects PM (particulate matter) from the exhaust gas. The DPF is installed in the catalytic converter.

How the DPF Works

The DPF periodically burns off the collected PM while driving at a high temperature of catalytic converter.

When PM is burned off, you may notice white smoke in the exhaust gas, and the increase in the average fuel consumption. This is temporary, and normal.

⚠ Diesel Particulate Filter (DPF)

The DPF must operate at a high temperature for the chemical reactions to take place. It can set on fire any combustible materials that come near it. Park your vehicle away from high grass, dry leaves, or other flammables.

Regenerating DPF

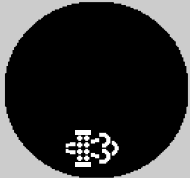

Regenerate the DPF when this symbol appears.



Take your vehicle to a dealer when this warning symbol appears.

If you see  on the multi-information display, you need to regenerate the DPF:

- Drive your vehicle at a speed of 60 km/h (37 mph) or over until the symbol disappears.
 - ▶ It takes about 20 minutes to increase the catalytic converter temperature to burn out and remove PM.

Regenerating DPF

NOTICE

If you ignore the symbol and do not regenerate the DPF, the multi-information display changes to the DPF warning symbol. If this happens, take your vehicle to a dealer as soon as possible. Continuously ignoring the multi-information display warning symbol causes the DPF to be clogged with PM, seriously damaging the DPF and emission control systems.

To minimize the accumulation of PM, always use the recommended diesel fuel.

 **Fuel recommendation** P. 523

PM is accumulated in the catalytic converter when you drive at a low speed for a long period of time or by frequent short journeys.

Replacing Light Bulbs

Headlight Bulbs

When replacing, use the following bulbs.

High beam headlight: 60 W (HB3 for halogen bulb type)
Low beam headlight: 55 W (H11 for halogen bulb type)*
35 W (D4S for high voltage discharge type)*

High Beam Headlight

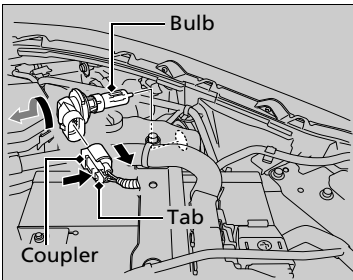

1. Remove the coupler.
 - ▶ It can be removed by pushing the tab.
2. Rotate the old bulb to the left to remove.
3. Insert a new bulb into the headlight assembly and turn it to the right.
4. Insert the coupler into the connector of the bulb.

Low Beam Headlights

Model with high voltage discharge low beam headlights

High voltage can remain in the circuit for a long period of time after the light is switched off. Do not attempt to inspect or replace the high voltage discharge type bulbs yourself. Ask a dealer to inspect and replace low beam headlights.

Headlight Bulbs

NOTICE

Halogen bulbs get very hot when lit. Oil, perspiration, or a scratch on the glass can cause the bulb to overheat and shatter.

The headlight aim is set by the factory, and does not need to be adjusted. However, if you regularly carry heavy items in the luggage area, have the aiming readjusted at a dealer or by a qualified technician.

The HB3 and H11 types are halogen bulbs. When replacing a halogen bulb, handle it by its base, and protect the glass from contact with your skin or hard objects. If you touch the glass, clean it with denatured alcohol and a clean cloth.

Model with halogen low beam headlights

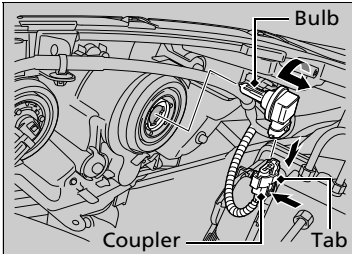

1. Remove the coupler.
 - ▶ It can be removed by pushing the tab.
2. Rotate the old bulb to the left to remove.
3. Insert a new bulb into the headlight assembly and turn it to the right.
4. Insert the coupler into the connector of the bulb.

Position Light and Daytime Running Light Bulbs

Position Light and Daytime Running Light bulbs are LED type. Have an authorized Honda dealer inspect and replace the light assembly.

Front Turn Signal Light Bulbs

When replacing, use the following bulbs.

Front Turn Signal Light: 21 W (Amber)

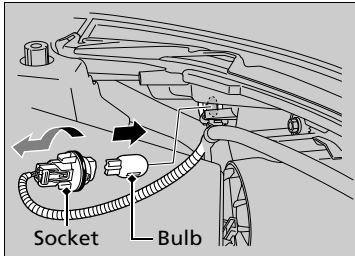

1. Turn the socket to the left and remove it.
2. Remove the old bulb and insert a new bulb.

Active Cornering Light Bulbs *

Active Cornering Light bulbs are LED type. Have an authorized Honda dealer inspect and replace the light assembly.

Side Turn Signal/Emergency Indicator Light Bulbs

Door mirrors have the side turn lights. Have an authorized Honda dealer inspect and replace the light assembly.

Fog Light Bulbs*

When replacing, use the following bulbs.

Fog Light: 35 W (H8 for halogen bulb type)

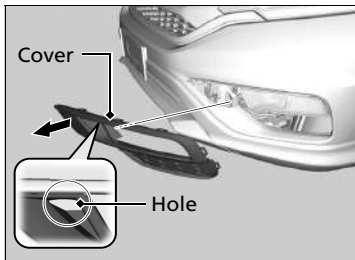

1. Pull the hole of the cover with your finger, then remove it.

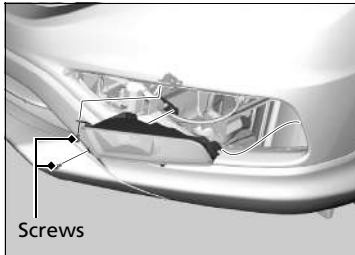

2. Remove the screws using a Phillips-head screwdriver and carefully pull the fog light assembly out of the bumper.

☒ Fog Light Bulbs*

NOTICE

Halogen bulbs get very hot when lit. Oil, perspiration, or a scratch on the glass can cause the bulb to overheat and shatter.

The fog lights are halogen bulbs. When replacing a bulb, handle it by its plastic case, and protect the glass from contact with your skin or hard objects. If you touch the glass, clean it with denatured alcohol and a clean cloth.

* Not available on all models

Continued

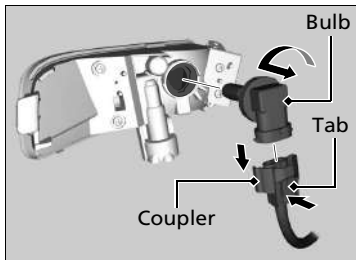

3. Push the tab to remove the coupler.
4. Rotate the old bulb to the left to remove.
5. Insert new bulb.

Back-Up Light and Rear Turn Signal Light Bulbs

When replacing, use the following bulbs.

Back-Up Light:	21 W
Rear Turn Signal Light:	21 W (Amber)

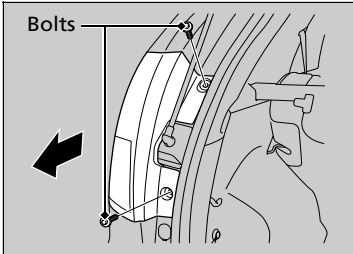

1. Use a Phillips-head screwdriver to remove the bolts.
2. Pull the light assembly out of the rear pillar.

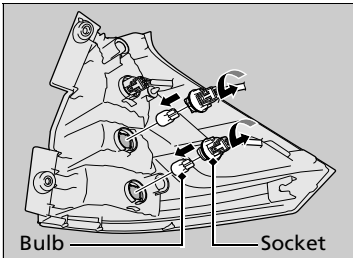

3. Turn the socket to the left and remove it. Remove the old bulb.
4. Insert a new bulb.

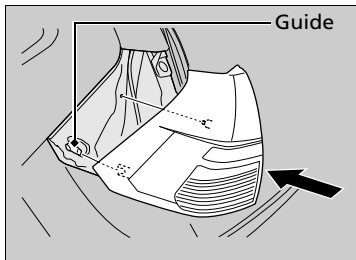

5. Reinstall the light assembly by sliding it on to the guide on the body.

Brake/Tail-light Bulbs

Brake/Tail-light bulbs are LED type. Have an authorized Honda dealer inspect and replace the light assembly.

Rear Licence Plate Light Bulb

When replacing, use the following bulbs.

Rear Licence Plate Light: 5 W

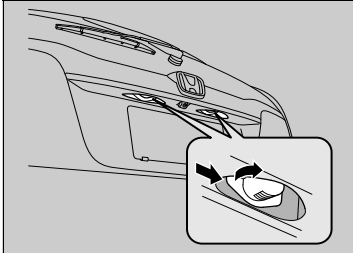

1. Push the left edge of the lens to the right and pull out the licence light assembly.

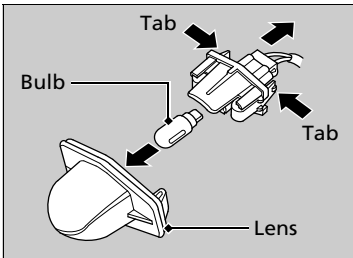

2. Push the tabs to remove the lens.

3. Remove the old bulb.

4. Insert a new bulb.

High-Mount Brake Light Bulb

High-mount brake light bulbs are LED type. Have an authorized Honda dealer inspect and replace the light assembly.

Rear Fog Light

When replacing, use the following bulbs.

Rear Fog Light: 21 W

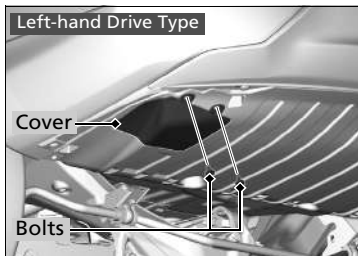

Left-hand Drive Type

1. Use a Phillips-head screwdriver to remove the bolts.
2. Remove the cover.

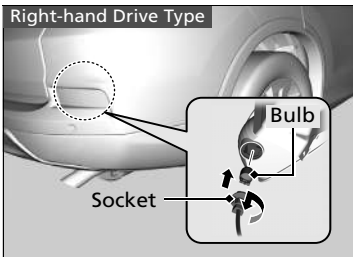
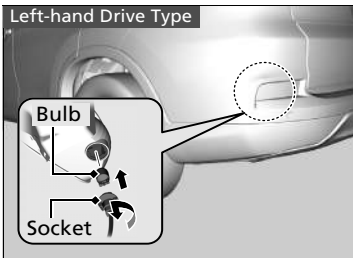

All models

3. Turn the socket to the left and remove it.
Remove the old bulb.
4. Insert a new bulb.

Other Light Bulbs

■ Ceiling Light Bulb

When replacing, use the following bulb.

Ceiling Light: 8 W

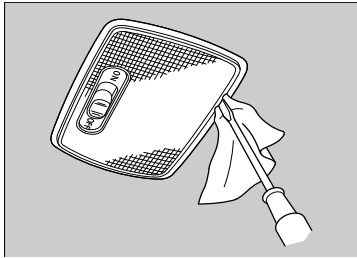

1. Pry on the edge of the cover using a flat-tip screwdriver to remove the cover.
 - Wrap the flat-tip screwdriver with a cloth to prevent scratches.

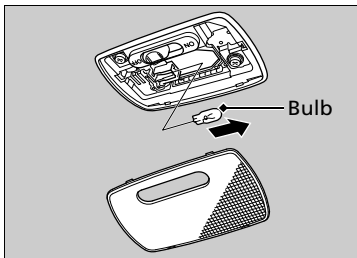

2. Remove the old bulb and insert a new bulb.

■ Map Light Bulbs

When replacing, use the following bulbs.

Map Light: 8 W

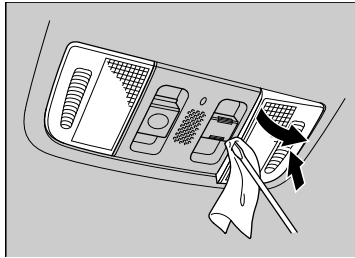

1. Pry on the edge of the cover using a flat-tip screwdriver to remove the cover.
 - Wrap the flat-tip screwdriver with a cloth to prevent scratches.

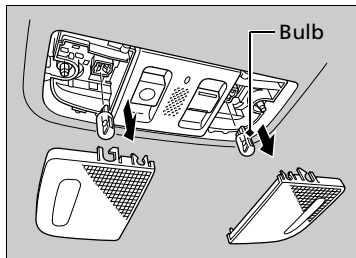

2. Remove the old bulb and insert a new bulb.

■ Vanity Mirror Light Bulbs*

When replacing, use the following bulbs.

Vanity Mirror Light: 2 W

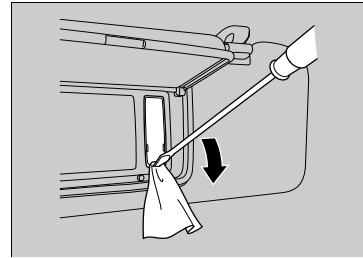

1. Pry on the edge of the cover using a flat-tip screwdriver to remove the cover.
 - Wrap the flat-tip screwdriver with a cloth to prevent scratches.

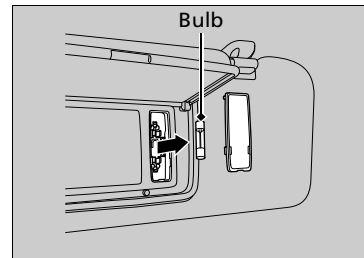

2. Remove the old bulb and insert a new bulb.

■ Luggage Area Light Bulb

When replacing, use the following bulb.

Luggage Area Light: 8 W

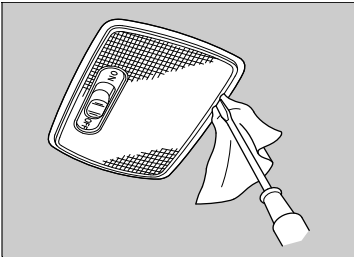

1. Pry on the edge of the cover using a flat-tip screwdriver to remove the cover.
 - Wrap the flat-tip screwdriver with a cloth to prevent scratches.

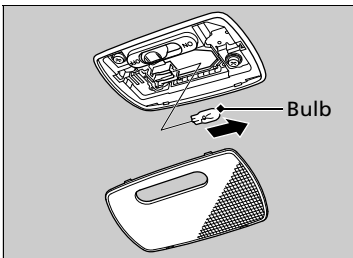

2. Remove the old bulb and insert a new bulb.

* Not available on all models

■ Glove Box Light Bulb*

When replacing, use the following bulbs.

Glove Box Light: 3.4 W

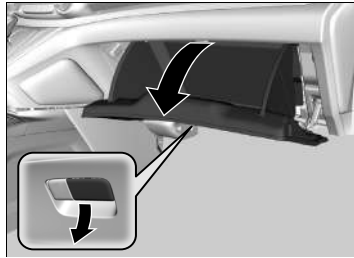

1. Open the glove box.

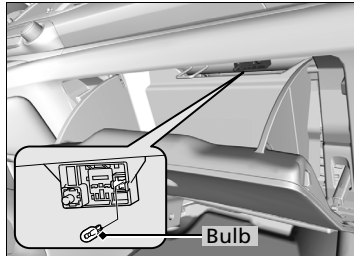

2. Remove the old bulb and insert a new bulb.

Checking and Maintaining Wiper Blades

Checking Wiper Blades

If the wiper blade rubber has deteriorated, it will leave streaks and the hard surfaces of the blade may scratch the window glass.

Changing the Front Wiper Blade Rubber

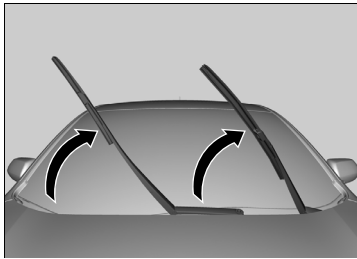

1. Lift the driver side wiper arm first, then the passenger side.

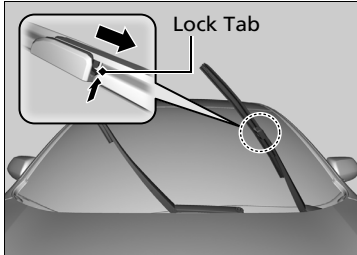

2. Push the lock tab up.
3. Slide the blade from the wiper arm.

Changing the Front Wiper Blade Rubber

NOTICE

Avoid dropping the wiper blade; it may damage the windshield.

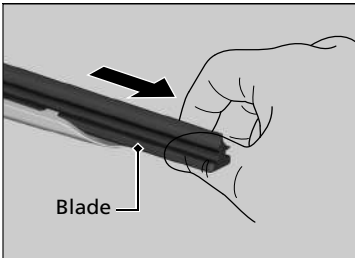

- 4.** Slide the wiper blade out from its holder by pulling the tabbed end out.

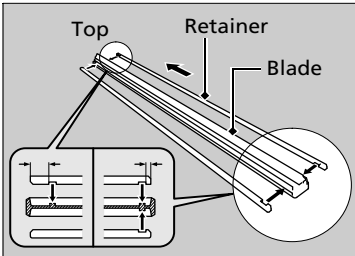

- 5.** Remove the retainer from the rubber blade that has been removed, and mount to a new rubber blade.
 ▶ Correctly align the rubber protrusion and the retainer grooves.

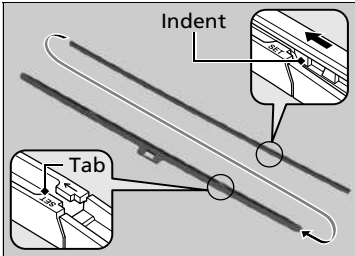

- 6.** Slide the new wiper blade onto the holder from the bottom end.
 ▶ The tab on the holder should fit in the indent of the wiper blade.
- 7.** Slide the wiper blade onto the wiper arm, then push down the lock tab.
- 8.** Lower the passenger side wiper arm first, then the driver side.

Changing the Rear Wiper Blade Rubber

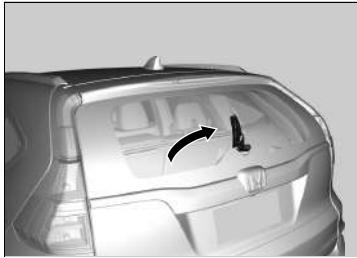

1. Raise the wiper arm off.

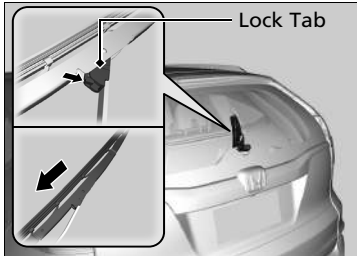

2. Pull up the lock tab and release the wiper arm.

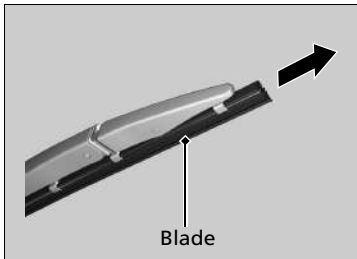

3. Slide the wiper blade out from the end with the indent.

Changing the Rear Wiper Blade Rubber

NOTICE

Avoid dropping the wiper arm; it may damage the windscreen.

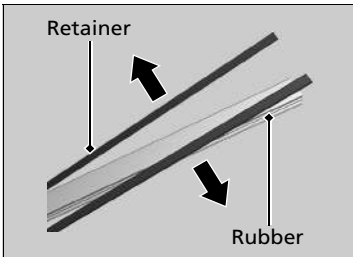

4. Remove the retainers from wiper blade and mount to a new rubber blade.

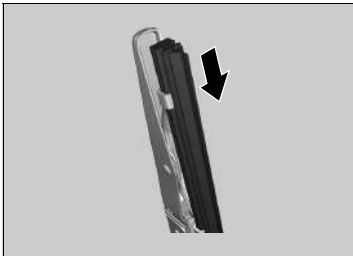

5. Slide the wiper blade onto the holder.
▶ Make sure it is engaged correctly, then install the wiper blade assembly onto the wiper arm.

Checking Tyres

To safely operate your vehicle, your tyres must be of the proper type and size, in good condition with adequate tread, and properly inflated.

■ Inflation guidelines

Properly inflated tyres provide the best combination of handling, tread life, and comfort. Refer to the driver's doorjamb label for the specified pressure.

Underinflated tyres wear unevenly, adversely affect handling and fuel economy, and are more likely to fail from overheating.

Overinflated tyres make your vehicle ride harshly, are more prone to road hazards, and wear unevenly.

Every day before you drive, look at each of the tyres. If one looks lower than the others, check the pressure with a tyre gauge.

At least once a month or before long trips, use a gauge to measure the pressure in all tyres, including the spare*. Even tyres in good condition can lose 10 to 20 kPa (0.1 to 0.2 bar, 1 to 2 psi) per month.

■ Inspection guidelines

Every time you check inflation, also examine the tyres and valve stems.

Look for:

- Bumps or bulges on the side or in the tread. Replace the tyre if you find any cuts, splits, or cracks in the side of the tyre. Replace it if you see fabric or cord.
- Remove any foreign objects and inspect for air leaks.
- Uneven tread wear. Have a dealer check the wheel alignment.
- Excessive tread wear.
 - **Wear Indicators** P. 581
- Cracks or other damage around valve stem.

* Not available on all models

➤ Checking Tyres

⚠ WARNING

Using tyres that are excessively worn or improperly inflated can cause a crash in which you can be seriously hurt or killed.

Follow all instructions in this owner's manual regarding tyre inflation and maintenance.

Measure the air pressure when tyres are cold. This means the vehicle has been parked for at least three hours, or driven less than 1.6 km (1 mile). If necessary, add or release air until the specified pressure is reached.

If checked when hot, tyre pressure can be as much as 30 – 40 kPa (0.3 – 0.4 bar, 4 – 6 psi) higher than if checked when cold.

Whenever tyre pressure is adjusted, you must calibrate the deflation warning system.

➤ **Deflation Warning System Calibration**
P. 484

Have a dealer check the tyres if you feel a consistent vibration while driving. New tyres and any that have been removed and reinstalled should be properly balanced.

Wear Indicators

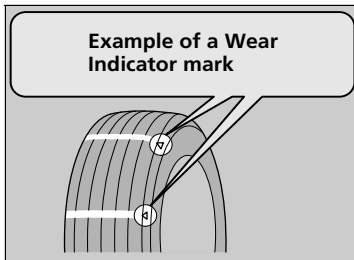

The groove where the wear indicator is located is 1.6 mm shallower than elsewhere on the tyre. If the tread has worn so that the indicator is exposed, replace the tyre. **Worn out tyres have poor traction on wet roads.**

Tyre Service Life

The life of your tyres is dependent on many factors, including driving habits, road conditions, vehicle loading, inflation pressure, maintenance history, speed, and environmental conditions (even when the tyres are not in use).

In addition to regular inspections and inflation pressure maintenance, it is recommended that you have annual inspections performed once the tyres reach five years old. All tyres, including the spare*, should be removed from service after 10 years from the date of manufacture, regardless of their condition or state of wear.

* Not available on all models

Tyre and Wheel Replacement

Replace your tyres with radials of the same size, load range, speed rating, and maximum cold tyre pressure rating (as shown on the tyre's sidewall). Using tyres of a different size or construction can cause the ABS and VSA (vehicle stability assist) hill start assist, the AWD system to work incorrectly.

It is best to replace all four tyres at the same time. If that isn't possible, replace the front or rear tyres in pairs.

Make sure that the wheel's specifications match those of the original wheels.

▣ Tyre and Wheel Replacement

WARNING

Installing improper tyres on your vehicle can affect handling and stability. This can cause a crash in which you can be seriously hurt or killed.

Always use the size and type of tyres recommended in the tyre information label on your vehicle.

Tyre Rotation

Rotating tyres according to the maintenance schedule helps to distribute wear more evenly and increase tyre life.

■ Your Vehicle's Tyre Rotation Pattern

Rotate the tyres as shown here.

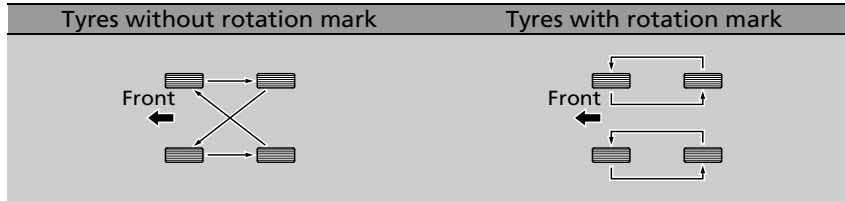

☒ Tyre Rotation

Tyres with directional tread patterns should only be rotated front to back (not from one side to the other). Directional tyres should be mounted with the rotation indication mark facing forward, as shown below.

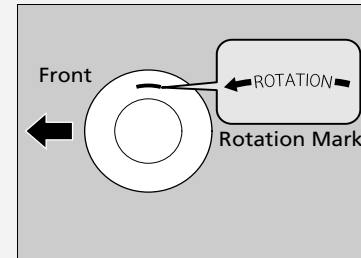

When the tyres are rotated, make sure the air pressures are checked.

Whenever tyres are rotated, you must calibrate the deflation warning system.

☒ Deflation Warning System Calibration

P. 484

Snow Traction Devices

If driving on snowy or frozen roads, mount winter tyres, or tyre chains; reduce speed; and maintain sufficient distance between vehicles when driving.

Be particularly careful when operating the steering wheel or brakes to prevent skidding.

Use tyre chains, winter tyres, or all season tyres when necessary or according to the law.

When mounting, refer to the following points.

For winter tyres:

- Select the size and load ranges that are the same as the original tyres.
- Mount the tyres to all four wheels.

For tyre chains:

- Consult a dealer before purchasing any type of chains for your vehicle.
- Install them on the front tyres only.
- Because your vehicle has limited tyre clearance, we strongly recommend using the chains listed below:

Original Tyre Size*1	Chain Type
225/65R17 102H	RUD matic CLASSIC V 19643
225/60R18 100H	RUD matic CLASSIC V 19642

*1: Original tyre size is mentioned on the tyre information label on the driver's doorjamb.

- Follow the chain manufacturer's instruction when installing. Mount them as tightly as you can.
- Check that the chains do not touch the brake lines or suspension.
- Drive slowly.

► Snow Traction Devices

⚠ WARNING

Using the wrong chains, or not properly installing chains, can damage the brake lines and cause a crash in which you can be seriously injured or killed.

Follow all instructions in this owner's manual regarding the selection and use of tyre chains.

NOTICE

Traction devices that are the wrong size or improperly installed can damage your vehicle's brake lines, suspension, body, and wheels. Stop driving if they are hitting any part of the vehicle.

According to the EEC Directive for tyres, when winter tyres are used, it is necessary to affix a sticker with the allowable max. speed of the winter tyres clearly in the field of view of the driver, if the designed max. speed of vehicle is higher than the allowed max. speed of winter tyre. A sticker is obtainable from your tyre dealer. If you have any question, consult a dealer.

When tyre chains are mounted, follow the chain manufacturer's instructions regarding vehicle operational limits.

Use tyre chains only in an emergency or when they are legally required for driving through a certain area.

Use greater caution when driving with tyre chains on snow or ice. They may have less-predictable handling than good winter tyres without chains.

Checking the Battery

Check the battery terminals for corrosion monthly.

If your vehicle's battery is disconnected or goes dead:

- The audio system is disabled.
 - **Reactivating the audio system** P. 244
- The clock resets.
 - **Clock** P. 156
- The navigation system is disabled. A PIN code will be required.
 - **Refer to the navigation system manual**

Battery

⚠ WARNING

The battery gives off explosive hydrogen gas during normal operation.

A spark or open flame can cause the battery to explode with enough force to kill or seriously hurt you.

Keep all sparks, open flames, and smoking materials away from the battery.

Wear protective clothing and a face shield, or have a skilled technician do any battery maintenance.

⚠ WARNING

The battery contains sulfuric acid (electrolyte) which is highly corrosive and poisonous.

Getting electrolyte in your eyes or on your skin can cause serious burns. Wear protective clothing and eye protection when working on or near the battery.

Swallowing electrolyte can cause fatal poisoning if immediate action is not taken.

KEEP OUT OF THE REACH OF CHILDREN

Charging the Battery

Disconnect both battery cables to prevent damaging your vehicle's electrical system. Always disconnect the negative (-) cable first, and reconnect it last.

Replacing the Battery

When you remove and replace the battery, always follow the maintenance safety and the warnings for when checking the battery to prevent potential hazards.

➤ **Maintenance Safety** P. 529

➤ **Checking the Battery** P. 585

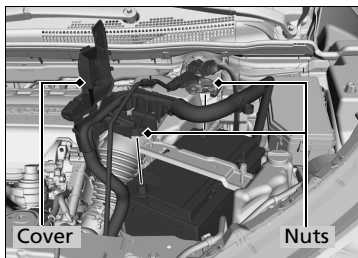

1. Turn the ignition switch to LOCK **0***1. Open the bonnet.
2. Loosen the nut on the negative battery cable, then disconnect the cable from the negative (-) terminal.
3. Open the positive battery terminal cover. Loosen the nut on the positive battery cable, then disconnect the cable from the positive (+) terminal.
4. Loosen the nut on each side of the battery bracket with a wrench.
5. Pull the bottom end of each battery stay out of the hole on the battery base, and remove the combination of the battery bracket and the stays.

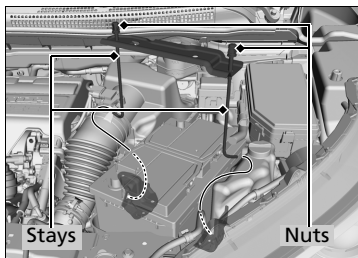

* 1: Models with the keyless access system have an **ENGINE START/STOP** button instead of an ignition switch.

➤ Battery

Emergency Procedures

Eyes: Flush with water from a cup or other container for at least 15 minutes. (Water under pressure can damage the eye.) Call a physician immediately.

Skin: Remove contaminated clothing. Flush the skin with large quantities of water. Call a physician immediately.

Swallowing: Drink water or milk. Call a physician immediately.

When you find corrosion, clean the battery terminals by applying a baking powder and water solution. Rinse the terminals with water. Cloth/towel dry the battery. Coat the terminals with grease to help prevent future corrosion.

➤ Replacing the Battery

NOTICE

An improperly disposed of battery can be harmful to the environment and human health. Always confirm local regulations for battery disposal.

This symbol on the battery means that this product must not be treated as household waste.



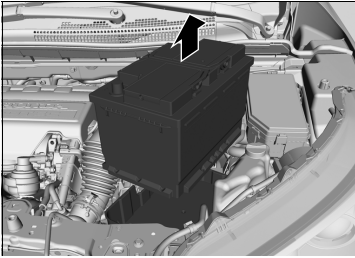

6. Take out the battery carefully.

▶ Replacing the Battery

Always disconnect the negative (–) cable first, and reconnect it last.

▶ Models with Auto Idle Stop

The battery installed in this vehicle is specifically designed for a model with Auto Idle Stop. Using a battery other than this specified type may shorten the battery life, and prevent Auto Idle Stop from activating. If you need to replace the battery, make sure to select the specified type. Ask a dealer for more details.

▶ **Specifications** P. 652, 655

Battery Label

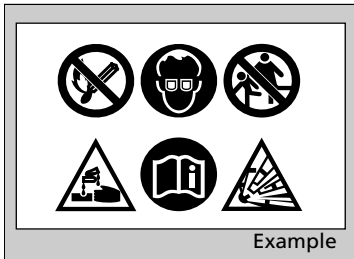

▶▶ Battery Label

DANGER

- Keep flames and sparks away from the battery. The battery produces explosive gas that can cause an explosion.
- Wear eye protection and rubber gloves when handling the battery to avoid risk of burns or loss of eyesight if exposed to battery electrolyte.
- Do not allow children to handle the battery, under any circumstance. Ensure that anyone handling the battery has a proper understanding of the hazards and correct handling procedures involved.
- Handle battery electrolyte with extreme care, as it contains dilute sulfuric acid. Exposure to eyes or skin can cause burns or loss of eyesight.
- Read this manual carefully, and understand it before handling the battery. Failure to do so can cause personal injury and damage to the vehicle.
- Do not use the battery if the level of electrolyte is at or below the recommended level. Using the battery with low electrolyte can cause it to explode, causing serious injury.

Replacing the Button Battery

If the indicator does not come on when the button is pressed, replace the battery.

Retractable Key*

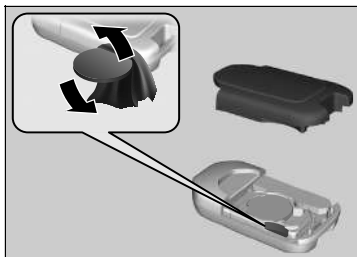

Battery type: CR2032

1. Remove the upper half of the cover by carefully prying on the edge with a coin.
▶ Wrap a coin with a cloth to prevent scratching the retractable key.

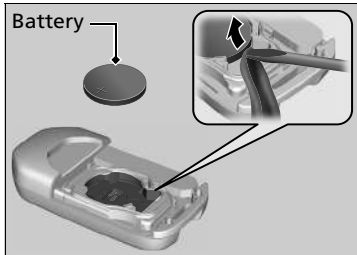

2. Remove the button battery with the small flat-tip screwdriver.
3. Make sure to replace the battery with the correct polarity.

Replacing the Button Battery

NOTICE

An improperly disposed of battery can damage the environment. Always confirm local regulations for battery disposal.

This symbol on the battery means that this product must not be treated as household waste.



Replacement batteries are commercially available or at a dealer.

* Not available on all models

■ Keyless Remote *



Battery type: CR2032

1. Remove the built-in key.

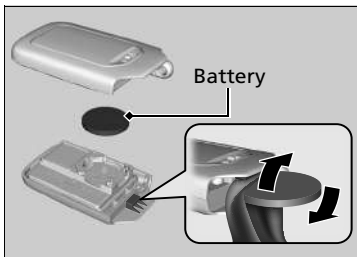

2. Remove the upper half by carefully prying on the edge with a coin.

▶ Remove carefully to avoid losing the buttons.

▶ Wrap a coin with a cloth to prevent scratching the keyless remote.

3. Make sure to replace the battery with the correct polarity.

Models with HFO-1234yf (R-1234yf)

Air Conditioning

For proper and safe operation of the climate control system, the refrigerant system should only be served by a qualified technician.

Never repair or replace the air conditioning evaporator (cooling coil) with one removed from a used or salvaged vehicle.

* Not available on all models

» Air Conditioning

NOTICE

Vented refrigerant is harmful to the environment. To avoid refrigerant from venting, never replace the evaporator with one removed from a used or salvaged vehicle.

Refrigerant in your vehicle's air conditioning system is flammable and can be ignited during servicing if proper procedures are not followed.

Air Conditioner label is found under the bonnet:



-  : Caution
-  : Flammable Refrigerant
-  : Requires a qualified technician to service
-  : Air Conditioning System

Dust and Pollen Filter

■ When to Replace the Dust and Pollen Filter

Replace the dust and pollen filter according to your vehicle's recommended maintenance schedule. It is recommended to replace the filter even sooner if the vehicle has been driven in a dusty environment.

➤ **Maintenance Schedule*** P. 536

■ How to Replace the Dust and Pollen Filter

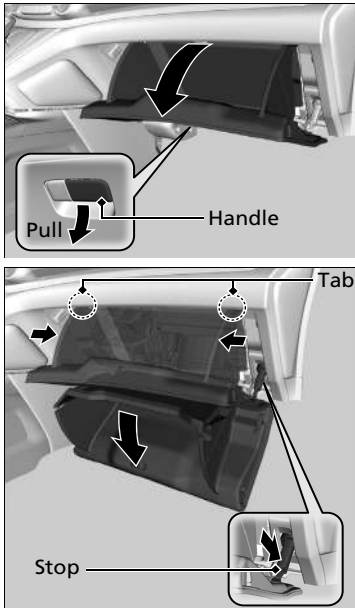

1. Open the glove box.

2. Disengage the two tabs by pushing on each side panel, then push down the stop.

3. Pivot the glove box out of the way.

➤ Dust and Pollen Filter

Using an air freshener may reduce the deodorizing effect of the dust and pollen filter, and may reduce its life.

If the airflow from the climate control system* deteriorates noticeably, and the windows fog up easily, the filter may need to be replaced.

The dust and pollen filter collects pollen, dust, and other debris in the air.

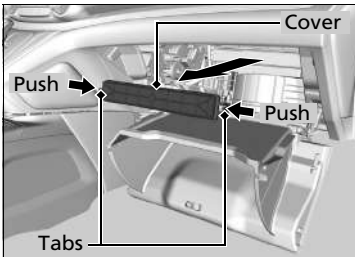

4. Push in the tabs on the corners of the filter case cover, and remove it.

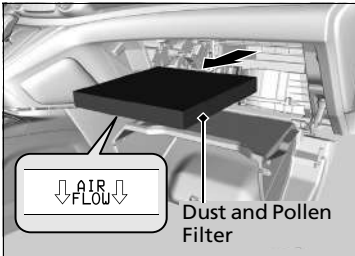

5. Remove the filter from the case.

6. Install a new filter in the case.

- Put the **AIR FLOW** arrow directed side down.

▣ Dust and Pollen Filter

If you are not sure how to replace the dust and pollen filter, have it replaced by a dealer.

Interior Care

Use a vacuum cleaner to remove dust before using a cloth.

Use a damp cloth with a mixture of mild detergent and warm water to remove dirt.

Use a clean cloth to remove detergent residue.

Cleaning Seat Belts

Use a soft brush with a mixture of mild soap and warm water to clean the seat belts.

Let the belts air dry. Wipe the openings of the seat belt anchors using a clean cloth.

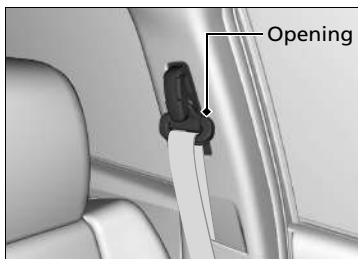

Cleaning the Window

Wipe using a glass cleaner.

Interior Care

Do not spill liquids inside the vehicle.

Electrical devices and systems may malfunction if liquids are splashed on them.

Do not use silicone based sprays on electrical devices such as audio devices and switches.

Doing so may cause the items to malfunction or a fire inside the vehicle.

If a silicone based spray is inadvertently used on electrical devices, consult a dealer.

Depending on their composition, chemicals and liquid aromatics may cause discoloration, wrinkles, and cracking to resin-based parts and textiles. Do not use alkali solvents or organic solvents such as benzene or petrol.

After using chemicals, make sure to gently wipe them off using a dry cloth.

Do not place used cloths on top of resin based parts or textiles for long periods of time without washing.

Be careful not to spill a liquid type air freshener.

Cleaning the Window

Wires are mounted to the inside of the rear window.

Wipe along the same direction as the wires with a soft cloth so as not to damage them.

■ Floor Mats (Optional)

The front floor mats hook over the floor anchors, which keep the mats from sliding forward. To remove a mat for cleaning, turn the anchor knobs to the unlock position. When reinstalling the mat after cleaning, turn the knobs to the lock position.

Do not put additional floor mats on top of the anchored mats.

■ Maintaining Genuine Leather*

Vacuum dirt and dust from the leather frequently. Pay close attention to the pleats and seams. Clean the leather with a soft cloth dampened with a 90% water and 10% neutral soap solution. Then buff it with a clean, dry cloth. Remove any dust or dirt on leather surfaces immediately.

* Not available on all models

▣ Floor Mats (Optional)

If you use any floor mats that were not originally provided with your vehicle, make sure they are designed for your specific vehicle, fit correctly, and are securely anchored by the floor anchors. Position the rear seat floor mats properly. If they are not properly positioned, the floor mats can interfere with the front seat functions.

Exterior Care

Dust off the vehicle body after you drive.

Regularly inspect your vehicle for scratches on painted surfaces. A scratch on a painted surface can result in body rust. If you find a scratch, promptly repair it.

■ Washing the Vehicle

Wash the vehicle frequently. Further, make sure to wash the vehicle in the following circumstances:

- If driving on roads with road salt.
- If driving in coastal areas.
- If tar, soot, bird droppings, insects, or tree sap are stuck to painted surfaces.

■ Using an Automated Car Wash

Fold in the door mirrors. Make sure to follow the instructions indicated on the automated car wash.

■ Using High Pressure Cleaners

- Keep sufficient distance between the cleaning nozzle and the vehicle body.
- Take particular care around the windows. Standing too close may cause water to enter the vehicle interior.
- Do not spray high pressure water directly into the engine compartment. Instead, use low pressure water and a mild detergent.

⌘ Washing the Vehicle

Do not spray water into the air intake vents or engine compartment. It can cause a malfunction.

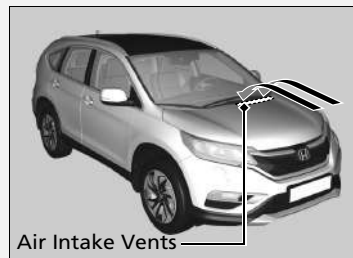

■ Applying Wax

A good coat of automotive body wax helps protect your vehicle's paint from the elements. Wax will wear off over time and expose your vehicle's paint to the elements, so reapply as necessary.

■ Maintaining the Bumpers and Other Resin Coated Parts

If you get petrol, oil, engine coolant, or battery fluid on resin coated parts, they may be stained or the coating may peel. Promptly wipe it away using a soft cloth and water.

■ Cleaning the Windows

Wipe using a glass cleaner.

■ Maintaining Aluminium Wheels

Aluminium is susceptible to deterioration caused by salt and other road contaminants. Use a sponge and mild detergent to wipe away promptly. Be careful not to use harsh chemicals (including some commercial wheel cleaners) or a stiff brush. They can damage the clear coat of the aluminium alloy wheels that helps keep the aluminium from corroding and tarnishing.

▶▶ Applying Wax

NOTICE

Chemical solvents and strong cleaners can damage the paint, metal, and plastic on your vehicle. Wipe up spills immediately.

▶▶ Maintaining the Bumpers and Other Resin Coated Parts

Ask a dealer about the correct coating material when you want to repair the painted surface of the parts made of resin.

■ Fogged Exterior Light Lenses

The inside lenses of exterior lights (headlights, brake lights, etc.) may fog temporarily if you have driven in the rain, or after the vehicle has been run through a car wash. Dew condensation also may build up inside the lenses when there is a significant enough difference between the ambient and inside lens temperatures (similar to vehicle windows fogging up in rainy conditions). These conditions are natural processes, not structural design problems in the exterior lights.

Lens design characteristics may result in moisture developing on the light lens frame surfaces. This also is not a malfunction.

However, if you see large amounts water accumulation, or large water drops building up inside the lenses, have your vehicle inspected by a dealer.

Accessories

When installing accessories, check the following:

- Do not install accessories on the windshield. They can obstruct your view and delay your reaction to driving conditions.
- Do not install any accessories over areas marked SRS Airbag, on the sides or backs of the front seats, on front or side pillars, or near the side windows. Accessories installed in these areas may interfere with proper operation of the vehicle's airbags or may be propelled into you or another occupant if the airbags deploy.
- Be sure electronic accessories do not overload electrical circuits or interfere with proper operation of your vehicle.
➤ **Fuses** P. 639
- Before installing any electronic accessory, have the installer contact a dealer for assistance. If possible, have a dealer inspect the final installation.

Modifications

Do not modify your vehicle in a manner that may affect its handling, stability, or reliability, or install non-genuine Honda parts or accessories that may have a similar effect.

Even minor modifications to vehicle systems can affect overall vehicle performance. Always make sure all equipment is properly installed and maintained, and do not make any modification to your vehicle or its systems that might cause your vehicle to no longer meet your country's and local regulations.

Do not modify or attempt to repair any of the electrical components.

Accessories and Modifications

⚠ WARNING

Improper accessories or modifications can affect your vehicle's handling, stability, and performance, and cause a crash in which you can be seriously hurt or killed.

Follow all instructions in this owner's manual regarding accessories and modifications.

When properly installed, mobile phones, alarms, two-way radios, radio antennas, and low-powered audio systems should not interfere with your vehicle's computer controlled systems, such as your airbags and anti-lock brakes.

Honda Genuine accessories are recommended to ensure proper operation on your vehicle.

Handling the Unexpected

This chapter explains how to handle unexpected troubles.

Tools	
Types of Tools.....	602
If a Tyre Goes Flat	
Changing a Flat Tyre *	603
Temporarily Repairing a Flat Tyre.....	611
Engine Does Not Start	
Checking the Engine.....	621
If the Keyless Remote Battery is Weak ...	623
Emergency Engine Stop	624
Jump Starting	625
Shift Lever Does Not Move	628
Emergency Parking Release	629

Overheating	
How to Handle Overheating.....	631
Indicator, Coming On/Blinking	
If the Low Oil Pressure Indicator Comes On....	633
If the Charging System Indicator Comes On... ..	633
If the Malfunction Indicator Lamp Comes On or Blinks	634
If the Brake System Indicator (Red) Comes On.....	634
If the Electric Power Steering (EPS) System Indicator Comes On	635
If the Low Tyre Pressure/Deflation Warning System Indicator Comes On or Blinks ...	636

If the Low Oil Level Indicator Comes On... ..	637
If the PGM-FI Symbol Appears	637
If the Transmission Indicator Blinks along with the Warning Message	638
Fuses	
Fuse Locations	639
Inspecting and Changing Fuses	646
Emergency Towing	647
When You Cannot Open the Tailgate	649
Refueling	
Refueling From a Portable Fuel Container ...	650

* Not available on all models

Types of Tools

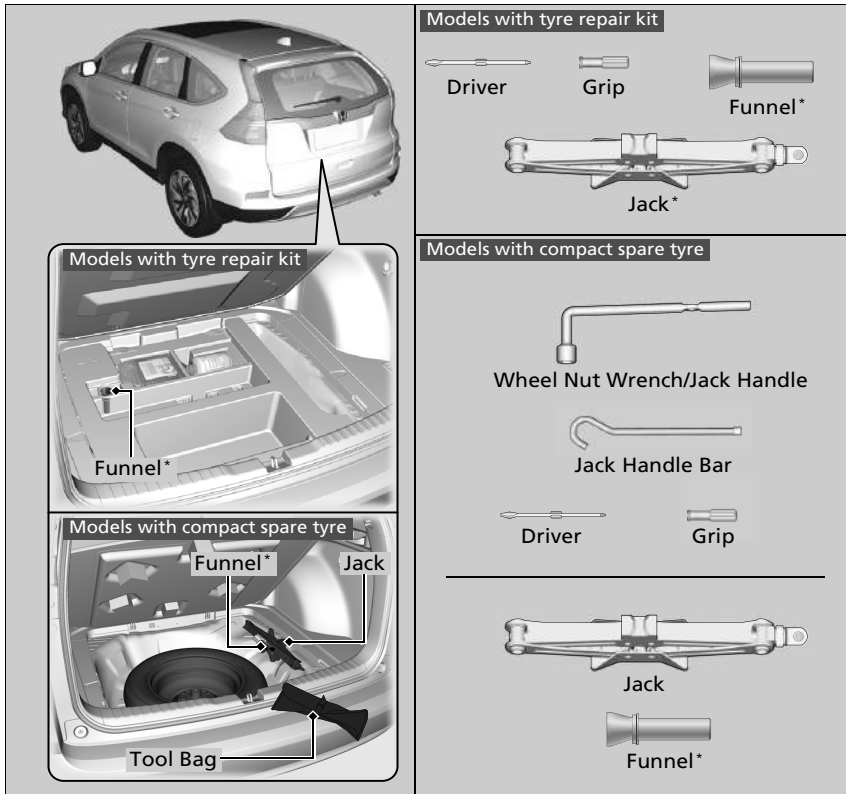

Types of Tools

The tools are stored in the luggage area.

Changing a Flat Tyre*

If a tyre goes flat while driving, grasp the steering wheel firmly, and brake gradually to reduce speed. Then, stop in a safe place. Replace the flat tyre with a compact spare tyre. Go to a dealer as soon as possible to have the full-size tyre repaired or replaced.

1. Park the vehicle on firm, level, and non-slippery surface and apply the parking brake.

Automatic transmission models

2. Change the gear position to **P**.

Manual transmission models

2. Move the shift lever to **R**.

All models

3. Turn on the hazard warning lights and turn the ignition switch to LOCK **0***1.

*1: Models with the keyless access system have an **ENGINE START/STOP** button instead of an ignition switch.

* Not available on all models

Changing a Flat Tyre*

Follow compact spare precautions:
Periodically check the tyre pressure of the compact spare*. It should be set to the specified pressure.
Specified Pressure: 420 kPa (4.2 bar, 60 psi)

When driving with the compact spare tyre, keep the vehicle speed under 80 km/h (50 mph). Replace with a full-size tyre as soon as possible.

The compact spare tyre and wheel in your vehicle are specifically for this model. Do not use them with another vehicle. Do not use another type of compact spare tyre or wheel with your vehicle.

Do not mount tyre chains on a compact spare tyre. If a chain-mounted front tyre goes flat, remove one of the full-size rear tyres and replace it with the compact spare tyre. Remove the flat front tyre and replace it with the full-size tyre that was removed from the rear. Mount the tyre chains on the front tyre.

A compact spare tyre gives a harsher ride and less traction on some road surfaces. Use greater caution while driving.

Do not use more than one compact spare tyre at the same time.

The compact spare tyre is smaller than the regular tyre. Your vehicle's ground clearance reduces when the compact spare tyre is installed. Driving over road debris or bumps could possibly damage the underside of your vehicle.

Continued

Getting Ready to Replace the Flat Tyre

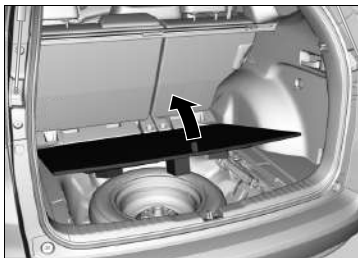

1. Open the luggage area floor lid.

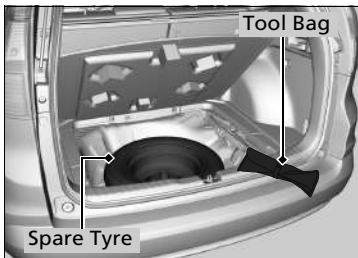

2. Take the tool bag out of the luggage area. Take the wheel nut wrench and jack-handle bar out of the tool bag.

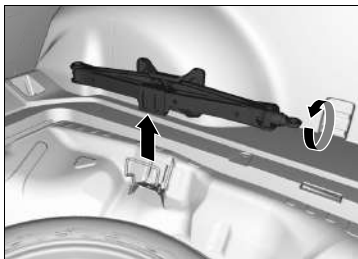

3. Take the jack out of the spare tyre area.
4. Unscrew the wing bolt, and remove the spacer cone. Then, remove the spare tyre.

Changing a Flat Tyre*

WARNING: The jack can only be used for helping an emergency vehicle breakdown, not for changing the regular seasonal tyre or any other normal maintenance or repair operation.

NOTICE

Do not use the jack if it doesn't work properly. Call your dealer or a professional towing service.

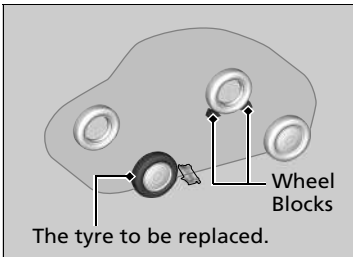

5. Place a wheel block or rock in front and rear of the wheel diagonal to the flat tyre.

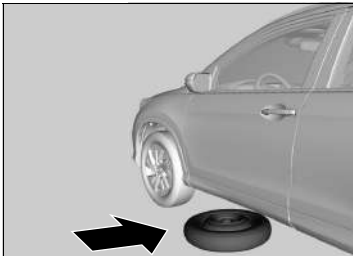

6. Place the spare tyre wheel side up under the vehicle body, near the tyre that needs to be replaced.



7. Loosen each wheel nut about one turn using the wheel nut wrench.

How to Set Up the Jack

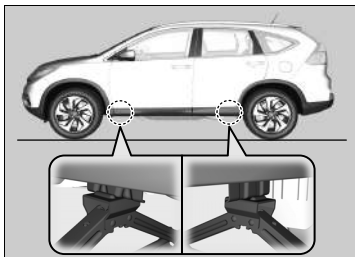

1. Place the jack under the jacking point closest to the tyre to be changed.
2. Turn the end bracket clockwise as shown in the image until the top of the jack contacts the jacking point.
 - ▶ Make sure that the jacking point tab is resting in the jack notch.

How to Set Up the Jack

WARNING

The vehicle can easily roll off the jack, seriously injuring anyone underneath.

Follow the directions for changing a tyre exactly, and no person should place any portion of their body under a vehicle that is supported by a jack.

WARNING: The jack shall be placed on a flat and stable surface on the same level as the vehicle is parked.

The jack that came with your vehicle has the following label.

1.	2.	3.

1. See Owner's Manual.
2. Never get under vehicle when supported by jack.
3. Place jack underneath reinforced area.

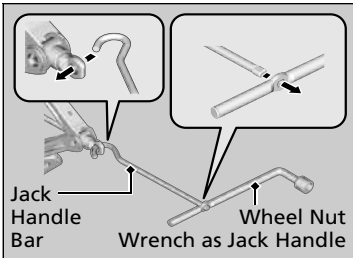

3. Raise the vehicle, using the jack handle bar and the jack handle, until the tyre is off the ground.

How to Set Up the Jack

Do not use the jack with people or luggage in the vehicle.

Use the jack provided in your vehicle. Other jacks may not support the weight ("load") or may not fit in the jacking point.

The following instructions must be followed to use the jack safely:

- Do not use while the engine is running.
- Use only where the ground is firm and level.
- Use only at the jacking points.
- Do not get in the vehicle while using the jack.
- Do not put anything on top of or underneath the jack.

Continued

■ Replacing the Flat Tyre

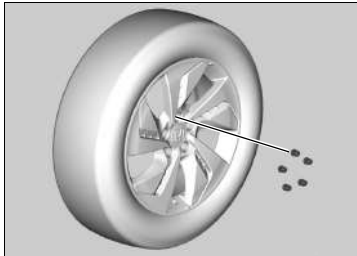

1. Remove the wheel nuts and flat tyre.

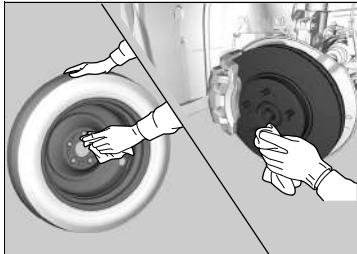

2. Wipe the mounting surfaces of the wheel with a clean cloth.

3. Mount the spare tyre.

4. Screw the wheel nuts until they touch the lips around the mounting holes, then stop rotating.

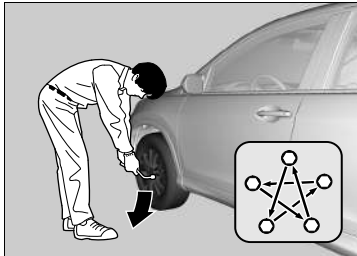

5. Lower the vehicle and remove the jack.

Tighten the wheel nuts in the order indicated in the image. Go around, tightening the nuts, two to three times in this order.

Wheel nut torque:

108 N·m (11 kgf·m, 80 lbf·ft)

▣ Replacing the Flat Tyre

Do not over tighten the wheel nuts by applying extra torque using your foot or a pipe.

Storing the Flat Tyre

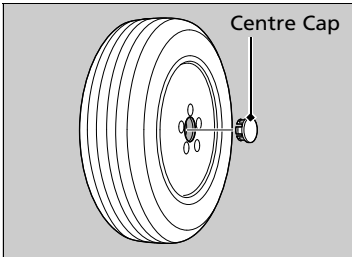

1. Remove the centre cap.

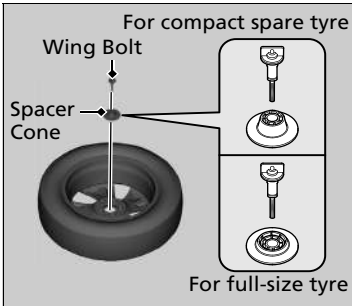

2. Place the flat tyre face down in the spare tyre well.
3. Remove the spacer cone from the wing bolt, flip it over, and insert it back on the bolt. Secure the flat tyre with the wing bolt.
4. Securely store the wheel nut wrench and jack handle bar back in the tool bag. Store the bag in the luggage area.
5. Store the jack in its holder. Turn the jack's end bracket to lock it in place.

Storing the Flat Tyre

⚠ WARNING

Loose items can fly around the interior in a crash and can seriously injure the occupants.
Store the wheel, jack, and tools securely before driving.

Continued

■ Deflation Warning System and the Spare Tyre

If you replace a flat tyre with the spare tyre,  indicator comes on while you are driving. After driving for a few kilometres (miles), the indicator will start blinking for a short time and then stay on, but this is normal.

Calibrate the deflation warning system when you replace the tyre with a specified regular tyre.

➤ **Deflation Warning System Calibration** P. 484

Temporarily Repairing a Flat Tyre

If the tyre has a large cut or is otherwise severely damaged, you will need to have the vehicle towed. If the tyre only has a small puncture, from a nail for instance, you can use the temporary tyre repair kit so that you can drive to the nearest service station for a more permanent repair.

If a tyre goes flat while driving, grasp the steering wheel firmly, and brake gradually to reduce speed. Then stop in a safe place.

1. Park the vehicle on firm, level, and non-slippery surface and apply the parking brake.

Automatic transmission models

2. Change the gear position to **P**.

Manual transmission models

2. Move the shift lever to **R**.

All models

3. Turn on the hazard warning lights and turn the ignition switch to LOCK **0***1.
 - When towing a trailer, unhitch the trailer.

*1: Models with the keyless access system have an **ENGINE START/STOP** button instead of an ignition switch.

Temporarily Repairing a Flat Tyre

The kit should not be used in the following situations. Instead, contact a dealer or roadside assistant to have the vehicle towed.

- The tyre sealant has expired.
- More than one tyre is punctured.
- The puncture or cut is larger than 4 mm (3/16 inch).
- The tyre side wall is damaged or the puncture is outside the contact area.

	When the puncture is:	Kit Use
	Smaller than 4 mm (3/16 inch)	Yes
	Larger than 4 mm (3/16 inch)	No

- Damage has been caused by driving with the tyres extremely under inflated.
- The tyre bead is no longer seated.
- A rim is damaged.

Do not remove a nail or screw that punctured the tyre. If you remove it from the tyre, you may not be able to repair the puncture using the kit.

Continued

Getting Ready to Temporarily Repair the Flat Tyre

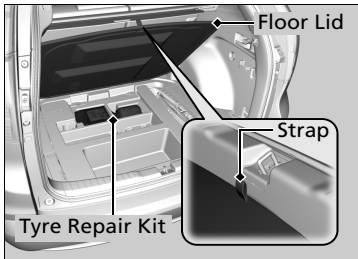
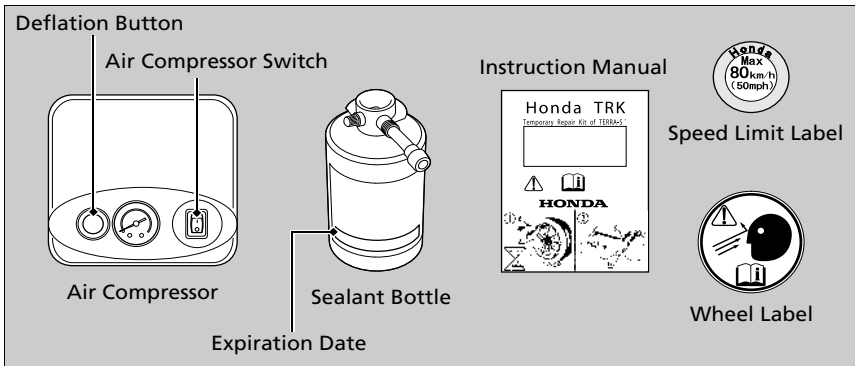

1. Pull up the strap and open the luggage area floor lid.
2. Take the kit out of the case.
3. Place the kit, face up, on flat ground near the flat tyre, away from traffic. Do not place the kit on its side.

Getting Ready to Temporarily Repair the Flat Tyre

When making a temporary repair, carefully read the instruction manual provided with the kit.

■ Injecting Sealant and Air

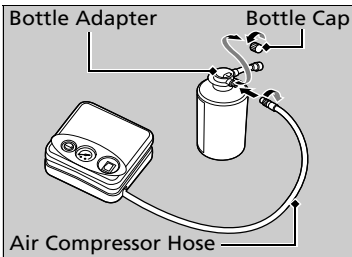
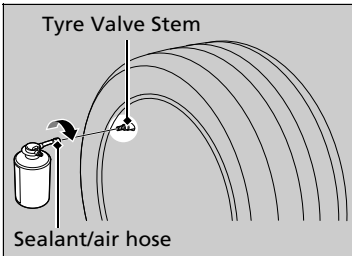
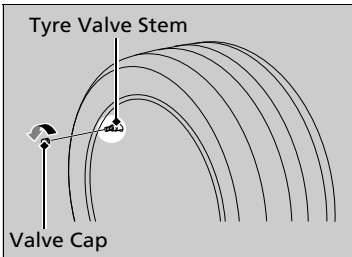

1. Remove the valve cap from the tyre valve stem.
2. Shake the sealant bottle.
3. Attach the sealant/air hose onto the tyre valve stem. Screw it until it is tight.
 - Make sure the bottle remains upright to ensure all the sealant flows into the tyre.
4. Remove the bottle cap from the bottle adapter.
5. Attach the air compressor hose onto the bottle adapter. Screw it until it is tight.

■ Injecting Sealant and Air

⚠ WARNING

Tyre sealant contains substances that are harmful and can be fatal if swallowed.

If accidentally swallowed, do not induce vomiting. Drink plenty of water and get medical attention immediately.

For skin or eye contact, flush with cool water and get medical attention if necessary.

Keep the sealant bottle out of the reach of children. Do not shake the bottle after the bottle cap removed. If you shake the bottle after the cap removed, it may spill sealant.

In cold temperatures, the sealant may not flow easily. In this situation, warm it up for five minutes before using.

The sealant is latex based and can permanently stain clothing and other materials. Be careful during handling and wipe up any spills immediately.

Continued

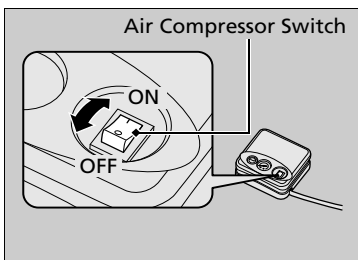
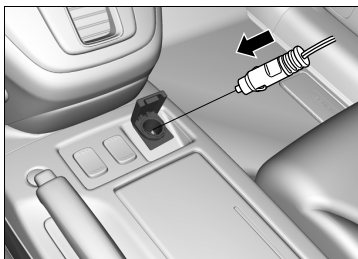

6. Plug in the compressor to the accessory power socket.

▶ Be careful not to pinch the cord in a door or window.

➤ **Accessory Power Sockets** P. 225

7. Turn the ignition switch to ACCESSORY *1.

▶ In freezing temperatures, start the engine and leave it running while the flat tyre is being serviced.

➤ **Carbon Monoxide Gas** P. 81

8. Turn the air compressor on to inflate the tyre.

▶ The compressor starts injecting sealant and air into the tyre.

9. After the air pressure reaches to specified pressure, turn off the kit.

▶ Check the air pressure gauge on the air compressor.

▶ Refer to the driver's doorjamb label for the specified pressure.

➤ Injecting Sealant and Air

⚠ WARNING

Running the engine with the vehicle in an enclosed or even partly enclosed area can cause a rapid build-up of toxic carbon monoxide.

Breathing this colourless, odourless gas can cause unconsciousness and even death. Only run the engine to power the air compressor with the vehicle outdoors.

NOTICE

Do not operate the temporary tyre repair kit compressor for more than 15 minutes. The compressor can overheat and become permanently damaged.

Until the sealant injection is complete, the pressure shown on the pressure gauge will appear higher than actual. After the sealant injection is complete the pressure will drop and then begin to rise again as the tyre is inflated with air. This is normal. To accurately measure the air pressure using the gauge, turn the air compressor off only after the sealant injection is complete.

If the required air pressure is not reached within 10 minutes, the tyre may be too severely damaged for the kit to provide the necessary seal and your vehicle will need to be towed.

See a Honda dealer for a replacement sealant bottle and proper disposal of an empty bottle.

*1: Models with the keyless access system have an **ENGINE START/STOP** button instead of an ignition switch.

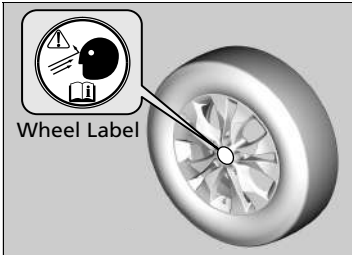
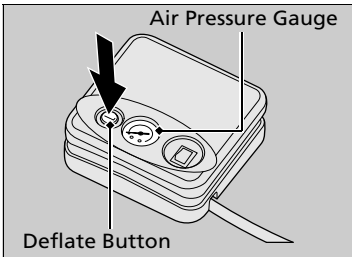

10. Unplug the kit from the accessory power socket.
11. Unscrew the sealant/air hose from the tyre valve stem. Reinstall the valve cap.
12. Push the deflate button until the gauge returns 0 kPa (0 psi).
13. Apply the wheel label to the flat surface of the wheel.
 - The wheel surface must be clean to ensure the label adheres properly.

■ Distributing the Sealant in the Tyre

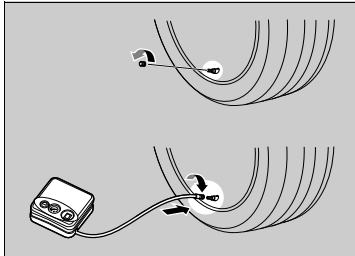
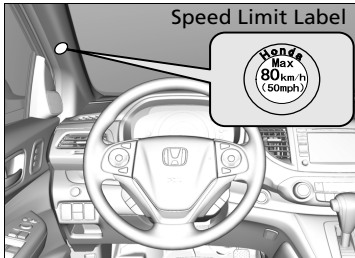

1. Apply the speed limit label to the location as shown.
2. Drive the vehicle for about 10 minutes.
 - ▶ Do not exceed 80 km/h (50 mph).
3. Stop the vehicle in a safe place.
4. Recheck the air pressure using the gauge on the air compressor.
 - ▶ Do not turn the air compressor on to check the pressure.
5. If the air pressure is:
 - Less than 130 kPa (19 psi):
Do not add air or continue driving. The leak is too severe. Call for help and have your vehicle towed.
 - Specified pressure more:
Continue driving for another 10 minutes or until you reach the nearest service station. Do not exceed 80 km/h (50 mph).
 - ▶ If the air pressure does not go down after the 10 minute driving, you do not need to check the pressure any more.

🚚 **Emergency Towing** P. 647

▣ Distributing the Sealant in the Tyre

Stop and recheck the air pressure after every 10 minutes of driving as necessary until you reach the nearest service station where you should have the tyre permanently repaired or replaced.

Refer to the driver's doorjamb label for the specified pressure.

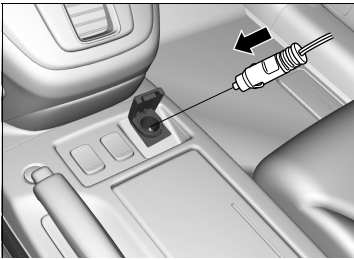

- Greater than 130 kPa (19 psi), but less than specified pressure:
Turn the air compressor switch on to inflate the tyre until the tyre pressure reaches specified pressure.

► **Injecting Sealant and Air** P. 613

Then drive carefully for 10 more minutes or until you reach the nearest service station. Do not exceed 50 mph (80 km/h).

► You should repeat this procedure as long as the air pressure is within this range.

6. Press the pressure deflate button until the gauge returns to 0 kPa (0 psi).
7. Repackage and properly stow the kit.

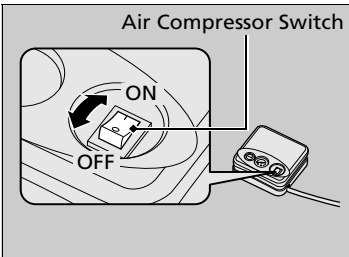

Air Compressor Switch

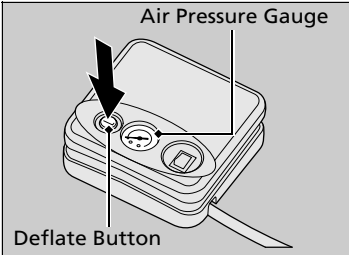

Air Pressure Gauge

Deflate Button

► **Distributing the Sealant in the Tyre**

Refer to the driver's doorjamb label for the specified pressure.

Continued

■ Inflating An Under-inflated Tyre

You can use the kit to inflate a non-punctured under-inflated tyre.

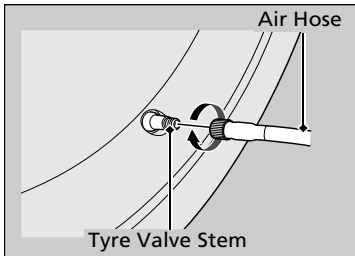
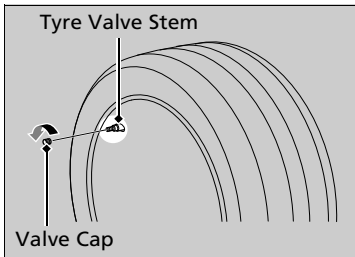
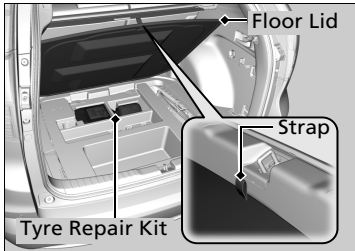

1. Pull up the strap and open the luggage area floor lid.
2. Take the kit out of the case.
3. Place the kit, face up, on flat ground near the flat tyre, away from traffic. Do not place the kit on its side.

4. Remove the valve cap.

5. Attach the air hose onto the tyre valve stem. Screw it until it is tight.

▶▶ Inflating An Under-inflated Tyre

NOTICE

Do not operate the temporary tyre repair kit compressor for more than 15 minutes. The compressor can overheat and become permanently damaged.

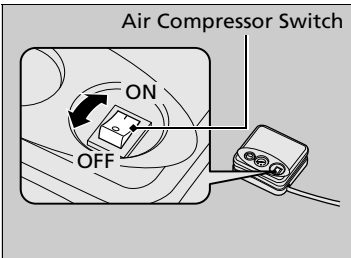
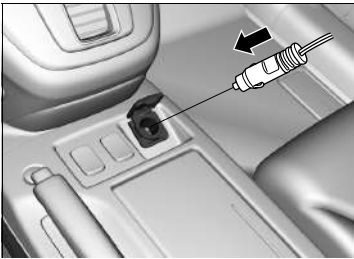

6. Plug in the compressor to the accessory power socket.
 - ▶ Be careful not to pinch the cord in a door or window.
 - **Accessory Power Sockets** P. 225
7. Turn the ignition switch to ACCESSORY ^{*1}.
 - ▶ In freezing temperatures, start the engine.
 - **Carbon Monoxide Gas** P. 81
8. Turn the air compressor switch on to inflate the tyre.
 - ▶ The compressor starts to inject air into the tyre.
 - ▶ If you have started the engine, leave it running while injecting air.
9. Inflate the tyre to the specified air pressure.
10. Turn off the kit.
 - ▶ Check the pressure gauge on the air compressor.
 - ▶ If overinflated, press the deflate button.

▶▶ Inflating An Under-inflated Tyre

⚠ WARNING

Running the engine with the vehicle in an enclosed or even partly enclosed area can cause a rapid build-up of toxic carbon monoxide. Breathing this colourless, odourless gas can cause unconsciousness and even death. Only run the engine to power the air compressor with the vehicle outdoors.

*1: Models with the keyless access system have an **ENGINE START/STOP** button instead of an ignition switch.

Continued

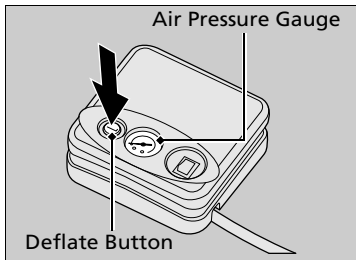

- 11.** Unplug the kit from the accessory power socket.
- 12.** Unscrew the air hose from the tyre valve stem. Reinstall the valve cap.
- 13.** Press the deflate button until the gauge returns 0 kPa (0 psi).
- 14.** Repackage and properly stow the kit.

Checking the Engine

If the engine does not start, check the starter.

▶ Checking the Engine

If you must start the vehicle immediately, use an assisting vehicle to jump start it.

▶ **Jump Starting** P. 625

Starter condition

Checklist

Starter doesn't turn or turns over slowly.

The battery may be dead. Check each of the items on the right and respond accordingly.

The starter turns over normally but the engine doesn't start.

There may be a problem with the fuses. Check each of the items on the right and respond accordingly.

Models with keyless access system

Check for a message on the multi-information display.

- If  appears
 - ▶ **If the Keyless Remote Battery is Weak** P. 623
 - ▶ Make sure the keyless remote is in its operating range.
 - ▶ **ENGINE START/STOP Button Operating Range** P. 185

Check the brightness of the interior lights.

Turn on the interior lights and check the brightness.

- If the interior lights are dim or do not come on at all
 - ▶ **Battery** P. 585
- If the interior lights come on normally ▶ **Fuses** P. 639

Review the engine start procedure.

Follow its instructions, and try to start the engine again. ▶ **Starting the Engine** P. 397, 400

Check the immobilizer system indicator.

When the immobilizer system indicator is blinking, the engine cannot be started.

▶ **Immobilizer System** P. 176

Check the fuel level.

There should be enough fuel in the tank. ▶ **Fuel Gauge** P. 128

Check the fuses.

Check all fuses, or have the vehicle checked by a dealer. ▶ **Inspecting and Changing Fuses** P. 646

If the problem continues:

▶ **Emergency Towing** P. 647

Starter condition

Checklist

The starter turns over normally but the engine doesn't start.

There may be a problem with the fuses. Check each of the items on the right and respond accordingly.

Diesel models

Have your vehicle checked by a dealer. If the malfunction indicator lamp comes on, or PGM-FI appears on the multi-information display under the following circumstances:

- The fuel tank has been run dry.
 - **Display Warning and Information Messages** P. 122
-

Diesel models

Have the fuel filter checked to drain off water.

-  appears on the multi-information display.
 - **Draining Water** P. 121
 - **Display Warning and Information Messages** P. 121
-

Models with keyless access system

If the Keyless Remote Battery is Weak

If the beeper sounds,  appears on the multi-information display, the indicator on the **ENGINE START/STOP** button flashes, and the engine won't start. Start the engine as follows.

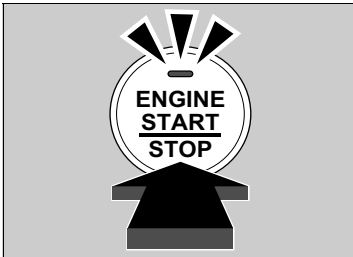
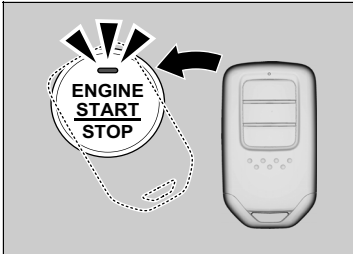

1. Touch the centre of the **ENGINE START/STOP** button with the **H** logo on the keyless remote while the indicator on the **ENGINE START/STOP** button is flashing. The buttons on the keyless remote should be facing you.
 - ▶ The indicator flashes for about 30 seconds.
2. Depress the brake pedal (automatic transmission) or clutch pedal (manual transmission) and press the **ENGINE START/STOP** button within 10 seconds after the beeper sounds and the indicator stays on.
 - ▶ If you don't depress the pedal, the mode will change to ACCESSORY.

Models with keyless access system

Emergency Engine Stop

If you cannot stop the engine by pressing the **ENGINE START/STOP** button, do either of the following operations:

- Press and hold the **ENGINE START/STOP** button for about two seconds.
- Firmly press the **ENGINE START/STOP** button twice.

The steering wheel will not lock.

9-speed automatic transmission models

The gear position automatically changes to **P** after the vehicle comes to a complete stop. Then, the power mode changes to VEHICLE OFF.

5-speed automatic transmission models

The power mode is in ACCESSORY when the engine is stopped.

To change the mode to VEHICLE OFF, move the shift lever to **P** after the vehicle comes to a complete stop. Then press the **ENGINE START/STOP** button twice without depressing the brake pedal.

Manual transmission models

The vehicle comes to a complete stop. After press the **ENGINE START/STOP** button three times without depressing the clutch pedal.

- ▶ The steering wheel will lock.

Emergency Engine Stop

Do not press the button while driving unless it is absolutely necessary for the engine to be switched off.

Jump Starting Procedure

Turn off the power to electric devices, such as audio and lights. Turn off the engine, then open the bonnet.

Petrol models

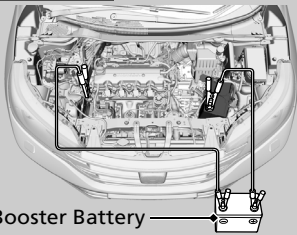

Diesel models

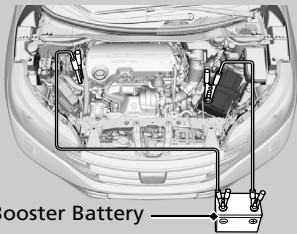

1. Connect the first jumper cable to your vehicle's battery \oplus terminal.
2. Connect the other end of the first jumper cable to the booster battery \oplus terminal.
 - ▶ Use a 12-volt booster battery only.
 - ▶ When using an automotive battery charger to boost your 12-volt battery, select a lower charging voltage than 15 volts. Check the charger manual for the proper setting.
3. Connect the second jumper cable to the booster battery \ominus terminal.

Jump Starting

⚠ WARNING

A battery can explode if you do not follow the correct procedure, seriously injuring anyone nearby.

Keep all sparks, open flames, and smoking materials away from the battery.

NOTICE

If a battery sits in extreme cold, the electrolyte inside can freeze. Attempting to jump start with a frozen battery can cause it to rupture.

Securely attach the jumper cables clips so that they do not come off when the engine vibrates. Also be careful not to tangle the jumper cables or allow the cable ends to touch each other while attaching or detaching the jumper cables.

Battery performance degrades in cold conditions and may prevent the engine from starting.

Continued

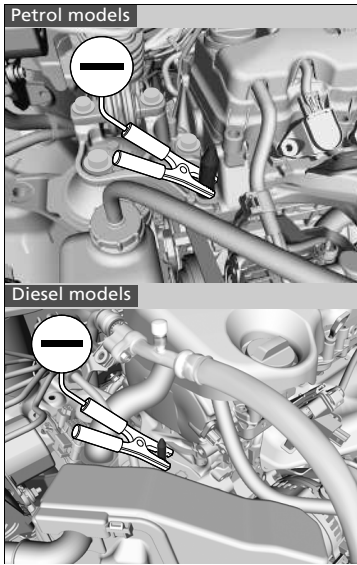

4. Connect the other end of the second jumper cable to the engine mounting bolt as shown. Do not connect this jumper cable to any other part.
5. If your vehicle is connected to another vehicle, start the assisting vehicle's engine and increase its rpm slightly.
6. Attempt to start your vehicle's engine. If it turns over slowly, check that the jumper cables have good metal-to-metal contact.

■ What to Do After the Engine Starts

Once your vehicle's engine has started, remove the jumper cables in the following order.

1. Disconnect the jumper cable from your vehicle's ground.
2. Disconnect the other end of the jumper cable from the booster battery \ominus terminal.
3. Disconnect the jumper cable from your vehicle's battery \oplus terminal.
4. Disconnect the other end of the jumper cable from the booster battery \oplus terminal.

Have your vehicle inspected by a nearby service station or a dealer.

Shift Lever Does Not Move

5-speed automatic transmission models

Follow the procedure below if you cannot move the shift lever out of the **P** position.

Releasing the Lock

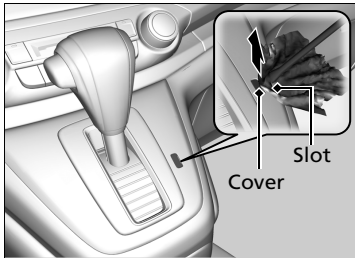

1. Set the parking brake.

Models without keyless access system

2. Remove the key from the ignition switch.

Models with keyless access system

2. Remove the built-in key from the keyless remote.

All models

3. Wrap a cloth around the tip of a small flat-tip screwdriver. Put it into the shift lock release slot as shown in the image, and remove the cover.

4. Insert the key into the shift lock release slot.

5. While pushing the key down, press the shift lever release button and place the shift lever into **N**.

▶ The lock is now released. Have the shift lever checked by a dealer as soon as possible.

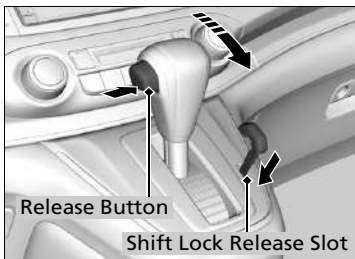

Emergency Parking Release

9-speed automatic transmission models

When the engine cannot be started due to dead battery, transmission failure, or engine trouble, transmission will be locked in **P** and immobilized.

In the case of dead battery, recharging the battery and restarting the engine to change the gear position.

If you cannot change the gear position even after recharging the battery, contact a dealer.

When you need to move your vehicle immediately in an emergency, you can disengage the parking lock in the transmission following the procedure below.

1. Make sure the vehicle is on a firm, level, and non-slippery surface and apply the parking brake completely.
2. Leave the ignition switch in ACCESSORY **I***1, and make sure steering lock is not on by turning steering wheel.
3. Open the bonnet.

➤ Opening the Bonnet P. 546



4. Insert a screwdriver into the hole in the shaft of the parking release bolt. Swing the screwdriver anticlockwise to loosen the parking release bolt.
▶ The parking release bolt is now loosened.

*1: Models with the keyless access system have an **ENGINE START/STOP** button instead of an ignition switch.

➤ Emergency Parking Release

⚠ WARNING

Never let the screwdriver come into contact with the battery terminals when loosening the parking release bolt.

The battery can explode if the screwdriver comes into contact with the battery terminals, seriously hurt or kill anyone nearby.

Always make sure whether the battery terminals are covered before loosening it.

When the ignition switch to LOCK **0***1, the gear position automatically changes to **P**.

➤ When turning off the engine P. 414

Do not attempt to perform any service while the steering wheel is locked; it may cause the steering inability.

Call a professional towing service and take your vehicle to a dealer.

Continued

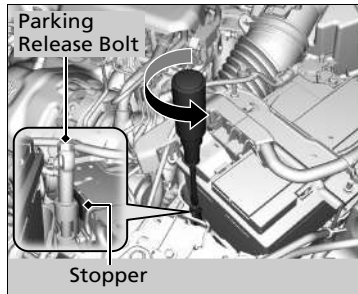

5. Insert the screwdriver in the screw head of the parking release bolt.

Rotate the bolt until it contacts stopper.

▶ The lock is now released.

The gear has been shifted from **P** to

N.

6. Park in a safe location.

7. When done, be sure to rotate the parking release bolt clockwise to return it back to the original position. And then, swing the screwdriver inserted in the hole in the shaft of the bolt clockwise to firmly tighten the bolt so that it may not be loosened.

▶ Tightening torque: 7 – 11 N·m (0.7 – 1.1 kgf·m, 5.2 – 8.1 lbf·ft)

Emergency Parking Release

If the parking release bolt is not returned to the original position and the ignition switch*1 is turned on, the transmission indicator flashes and the ignition switch cannot be turned to OFF.

➤ **Indicators** P. 84

After taking these steps, contact a dealer to have your vehicle checked.

*1: Models with the keyless access system have an **ENGINE START/STOP** button instead of an ignition switch.

How to Handle Overheating

Overheating symptoms are as follows:

- The temperature gauge needle is at the red (Hot) mark or the engine suddenly loses power.
- Steam or spray comes out of the engine compartment.

■ First thing to do

1. Immediately park the vehicle in a safe place.
2. Turn off all accessories and turn on the hazard warning lights.

▶ **No steam or spray present:**

Keep the engine running and open the bonnet.

▶ **Steam or spray present:**

Turn off the engine and wait until it subsides. Then, open the bonnet.

☒ How to Handle Overheating

⚠ WARNING

Steam and spray from an overheated engine can seriously scald you.

Do not open the bonnet if steam is coming out.

NOTICE

Continuing to drive with the temperature gauge needle at the red (Hot) mark on may damage the engine.

Continued

■ Next thing to do

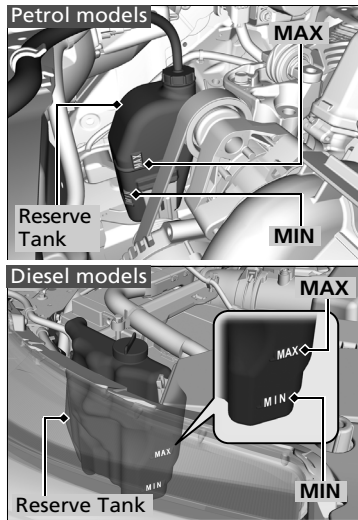

1. Check that the cooling fan is operating and stop the engine once the temperature gauge needle goes down.
 - If the cooling fan is not operating, immediately stop the engine.
2. Once the engine has cooled down, inspect the coolant level and check the cooling system components for leaks.
 - If the coolant level in the reserve tank is low, add coolant until it reaches the **MAX** mark.
 - If there is no coolant in the reserve tank, check that the radiator is cool. Cover the radiator cap with a heavy cloth and open the cap. If necessary, add coolant up to the base of the filler neck, and put the cap back on.

■ Last thing to do

Once the engine has cooled sufficiently, restart it and check the temperature gauge. If the temperature gauge needle has gone down, resume driving. If it has not gone down, contact a dealer for repairs.

► How to Handle Overheating

⚠ WARNING

Removing the radiator cap while the engine is hot can cause the coolant to spray out, seriously scalding you.

Always let the engine and radiator cool down before removing the radiator cap.

If the coolant is leaking, contact a dealer for repairs.

Use water as an emergency/temporary measure only. Have a dealer flush the system with proper antifreeze as soon as possible.

If the Low Oil Pressure Indicator Comes On



■ Reasons for the indicator to come on

Comes on when the engine oil pressure is low.

■ What to do as soon as the indicator comes on

1. Immediately park the vehicle on level ground in a safe place.
2. If necessary, turn the hazard warning lights on.

■ What to do after parking the vehicle

1. Stop the engine and let it sit for about three minutes.
2. Open the bonnet and check the oil level.
 - ▶ Add oil as necessary.
 - ▶ **Oil Check** P. 550
3. Start the engine and check the low oil pressure indicator.
 - ▶ The indicator goes off: Start driving again.
 - ▶ The indicator does not go off within 10 seconds: Stop the engine and contact a dealer for repairs immediately.

If the Charging System Indicator Comes On



■ Reasons for the indicator to come on

Comes on when the battery is not being charged.

■ What to do when the indicator comes on

Turn off the climate control system, rear demister, and other electrical systems, and immediately contact a dealer for repairs.

☒ If the Low Oil Pressure Indicator Comes On

NOTICE

Running the engine with low oil pressure can cause serious mechanical damage almost immediately.

☒ If the Charging System Indicator Comes On

If you need to stop temporarily, do not turn off the engine. Restarting the engine may rapidly discharge the battery.

If the Malfunction Indicator Lamp Comes On or Blinks



■ Reasons for the indicator lamp to come on or blink

- Comes on when there is a problem with the engine emissions control system.
- Blinks when engine misfiring is detected.

Diesel models

- Comes on when air may have entered the fuel system.

■ What to do when the indicator lamp comes on

Avoid high speeds and immediately get your vehicle inspected at a dealer.

■ What to do when the indicator lamp blinks

Park the vehicle in a safe place with no flammable items and wait at least ten minutes or more with the engine stopped until it cools.

If the Brake System Indicator (Red) Comes On



■ Reasons for the indicator to come on

- The brake fluid is low.
- There is a malfunction in the brake system.

■ What to do when the indicator comes on while driving

Press the brake pedal lightly to check pedal pressure.

- If normal, check the brake fluid level the next time you stop.
- If abnormal, take immediate action. If necessary, downshift the transmission to slow the vehicle using engine braking.

▶▶ If the Malfunction Indicator Lamp Comes On or Blinks

NOTICE

If you drive with the malfunction indicator lamp on, the emissions control system and the engine could be damaged.

If the malfunction indicator lamp blinks again when restarting the engine, drive to the nearest dealer at 50 km/h (30 mph) or less. Have your vehicle inspected.

▶▶ If the Brake System Indicator (Red) Comes On

Have your vehicle repaired immediately.

It is dangerous to drive with low brake fluid. If there is no resistance from the brake pedal, stop immediately in a safe place. If necessary downshift the gears.

If the brake system indicator and **ABS** indicator come on simultaneously, the electronic brake distribution system is not working. This can result in vehicle instability under sudden braking.

Have your vehicle inspected by a dealer immediately.

If the Electric Power Steering (EPS) System Indicator Comes On



■ Reasons for the indicator to come on

- Comes on when there is a problem with the EPS system.
- If you depress the accelerator pedal repeatedly to increase the engine speed while the engine is idling, the indicator comes on, and sometimes the steering wheel becomes harder to operate.

■ What to do when the indicator comes on

Stop the vehicle in a safe place and restart the engine.

If the indicator comes on and stays on, immediately have your vehicle inspected by a dealer.

If the Low Tyre Pressure/Deflation Warning System Indicator Comes On or Blinks



■ Reasons for the indicator to come on/blink

A tyre pressure is significantly low, or the deflation warning system has not been calibrated. If there is a problem with the deflation warning system is installed, the indicator blinks for about one minute, and then stays on.

■ What to do when the indicator comes on

Drive carefully and avoid abrupt cornering and hard braking. Stop your vehicle in a safe place. Check the tyre pressure and adjust the pressure to the specified level. The specified tyre pressure is on a label on the driver side doorjamb.

- ▶ Calibrate the deflation warning system after the tyre pressure is adjusted.

📖 **Deflation Warning System Calibration** P. 484

■ What to do when the indicator blinks, then remains on

Have the tyre inspected by a dealer as soon as possible. The indicator goes off after driving for a few kilometres (miles).

- ▶ Calibrate the deflation warning system after a full-size tyre is reinstalled.

📖 **Deflation Warning System Calibration** P. 484

📖 If the Low Tyre Pressure/Deflation Warning System Indicator Comes On or Blinks

NOTICE

Driving on an extremely underinflated tyre can cause it to overheat. An overheated tyre can fail. Always inflate your tyres to the prescribed level.

If the Low Oil Level Indicator Comes On



■ Reasons for the indicator to come on

Appears when the engine oil level is low.

■ What to do as soon as the indicator comes on

1. Immediately park the vehicle on level ground in a safe place.
2. If necessary, turn the hazard warning lights on.

■ What to do after parking the vehicle

1. Stop the engine and let it sit for about three minutes.
2. Open the bonnet and check the oil level.

▶ Add oil as necessary.

✉ **Oil Check** P. 550

Diesel models

If the PGM-FI Symbol Appears



■ Reasons for the symbol to appear while the engine is running

- There is a problem with the engine control system.

■ What to do when the symbol appears repeatedly

Avoid full-throttle acceleration and high speed driving. Have the vehicle checked by a dealer.

✉ If the Low Oil Level Indicator Comes On

NOTICE

Running the engine with low oil level can cause serious mechanical damage almost immediately.

This system activates after the engine warms up. If the outside temperature is extremely low, you may have to drive for a long time until the system senses the engine oil level.

If the indicator appears again, stop the engine and contact a dealer for repairs immediately.

✉ If the PGM-FI Symbol Appears

NOTICE

Continuously driving with this symbol on can damage the emissions controls and engine. Those repairs may not be covered by your vehicle's warranties.

9-speed automatic transmission models

If the Transmission Indicator Blinks along with the Warning Message



■ Reasons for the indicator to blink

There is a problem with the transmission.

■ What to do when the indicator blinks

- Immediately have your vehicle inspected by a dealer.
- Shift to **[N]** after starting the engine.
 - ▶ Check if the **[N]** position in the instrument panel.
 - ▶ The engine cannot be turned on unless the parking brake is set.
 - **Starting the Engine** P. 400

➤ If the Transmission Indicator Blinks along with the Warning Message

You may not be able to start the engine.

Make sure to set the parking brake when parking your vehicle.

Call a professional towing service if you need to tow your vehicle.

➤ **Emergency Towing** P. 647

Fuse Locations

If any electrical devices are not working, turn the ignition switch to LOCK [0]*1 and check to see if any applicable fuse is blown.

■ Engine Compartment Fuse Box Type A

Located near the battery. Push the tabs to open the box.

Fuse locations are shown on the image below.

Locate the fuse in question by the fuse number in the image and chart.

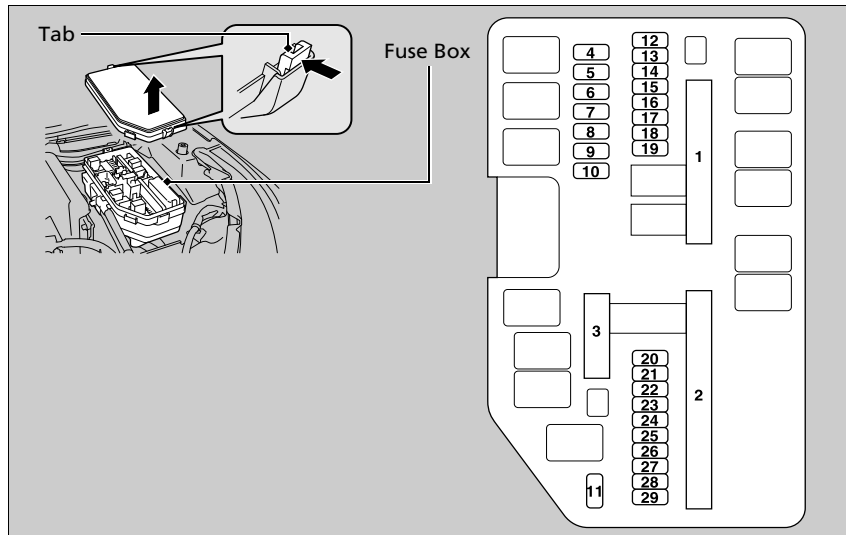

*1: Models with the keyless access system have an **ENGINE START/STOP** button instead of an ignition switch.

Continued

■ **Circuit protected and fuse rating**

	Circuit Protected	Amps
1	EPS	70 A
	Left e-pretensioner ^{*, *1}	(30 A)
	Glow ^{*2, *3}	(70 A)
	ABS/VSA Motor	40 A
	ABS/VSA FSR ^{*1}	(20 A)
	DC/DC 1 ^{*2, *3}	(30 A)
	E-DPS ^{*1}	30 A
	Main Fuse	100 A ^{*1} 150 A ^{*2, *3}

	Circuit Protected	Amps
2	IG Main	50 A
	Fuse Box Main	60 A
	Fuse Box Main 2	60 A
	Headlight High Main ^{*1}	30 A
	Headlight Main ^{*2, *3}	30 A
	ST Magnetic Switch ^{*1}	(30 A)
	Rear Demister ^{*1}	(30 A)
	Right e-pretensioner ^{*, *1}	(30 A)
	DC/DC 2 ^{*2, *3}	(30 A)
	Heater Motor	40 A
3	Front Wiper Main ^{*1}	30 A
	Rear Demister ^{*2, *3}	30 A
	Sub Fan Motor	20 A ^{*1} 30 A ^{*2, *3}
	Main Fan Motor	20 A ^{*1} 30 A ^{*2, *3}

	Circuit Protected	Amps
3	A/C PTC 1 ^{*2, *3}	(40 A)
	A/C PTC 2 ^{*2, *3}	(40 A)
	A/C PTC 3 ^{*2, *3}	(40 A)
	A/C PTC 4 ^{*2, *3}	(40 A)
4	–	–
5	–	–
6	UB ECU (R/B) ^{*3}	(7.5 A)
	Interior Lights ^{*2}	(7.5 A)
7	Buck Up ^{*2, *3}	(10 A)
8	Sub Fan RLY CL ^{*1}	(7.5 A)

*1: Petrol models

*2: Diesel models with Auto Idle Stop

*3: Diesel models without Auto Idle Stop

	Circuit Protected	Amps
9	IGPS* ^{2, *3}	(7.5 A)
	Heated Door Mirror* ¹	7.5 A
10	Interior Lights* ³	7.5 A
	Buck Up 2* ²	7.5 A
11	ST MG DIODE/STRLD* ¹	7.5 A
	STRLD* ^{2, *3}	7.5 A
12	Front Fog Lights*	20 A
	Audio Amp* ^{1, *3}	(20 A)
13	Left e-pretensioner (Min)* ²	(30 A)
14	Horn	10 A
15	Hazard	10 A
		(10 A)* ¹
16	Stop	(15 A)* ^{2, *3}

	Circuit Protected	Amps
17	IG Coil* ¹	(15 A)
	Laf* ^{2, *3}	(10 A)
18	IGP 2	15 A
19	ABS/VSR FSR (Min)* ^{2, *3}	(20 A)
	Passenger's Power Seat (Reclining)* ¹	(20 A)
20	AT TCU* ³	(20 A)
	Right e-pretensioner (Min)*, * ²	(30 A)
21	Headlight Washer*	(30 A)
	Drive By Wire* ¹	(15 A)
22	Back Up FI ECU* ^{2, *3}	(7.5 A)
23	IGP	(15 A)* ¹ (20 A)* ^{2, *3}
24	Left Headlight Low Beam	10 A* ⁴ 15 A* ⁵
25	Right Headlight Low Beam	10 A* ⁴ 15 A* ⁵

	Circuit Protected	Amps
26	Position Lights Main	20 A
27	MG Clutch	7.5 A
28	Interior Lights* ¹	(7.5 A)
	Back Up Interior Main* ^{2, *3}	(20 A)
29	Buck Up* ¹	(10 A)
	Rear ACC* ^{2, *3}	(20 A)

*1: Petrol models

*2: Diesel models with Auto Idle Stop

*3: Diesel models without Auto Idle Stop

*4: Models with halogen headlights

*5: Models with high voltage discharge headlights

* Not available on all models

Diesel models

Engine Compartment Fuse Box Type B

Located near the battery. Push the tabs to open the box.

Fuse locations are shown on the image below.

Locate the fuse in question by the fuse number in the image and chart.

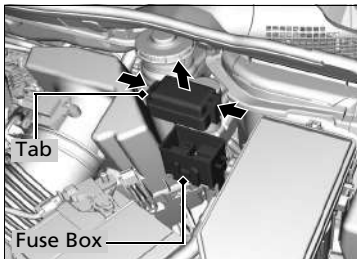

■ Circuit protected and fuse rating

	Circuit Protected	Amps
1	Shift By Wire	7.5 A

Driver Side Interior Fuse Box

Located under the dashboard.

Fuse locations are shown on the image below.

Locate the fuse in question by the fuse number in the image and chart.

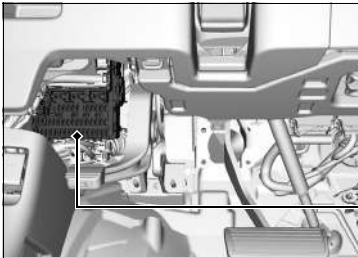

Fuse Box

Left-hand drive type

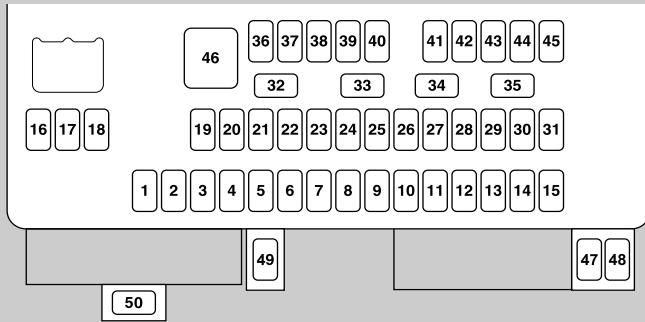

Right-hand drive type

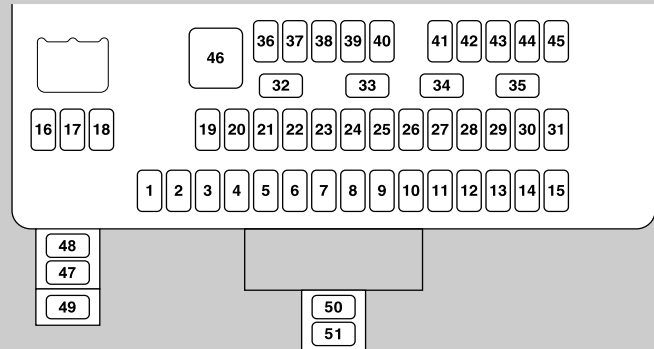

■ Circuit protected and fuse rating

	Circuit Protected	Amps
1	–	–
2	ACG	10 A
3	SRS	10 A
4	Fuel Pump	15 A
5	Meter * ¹ Relay * ²	10 A
6	Power Window	7.5 A
7	VB SOL *	(7.5 A)
8	Passenger's Side Door Lock Motor (Unlock)	15 A
9	Rear Driver's Side Door Lock Motor (Unlock)	10 A
10	Daytime Running Lights	10 A
11	Sunshade *	(20 A)
12	Accessory Power Socket (Console Compartment)	20 A
13	Washer *	(15 A)
14	Seat Heaters *	(20 A)
15	Driver's Door Lock Motor (Unlock)	10 A
16	Driver's Power Seat Sliding *	(20 A)
17	Driver's Power Seat Reclining *	(20 A)

	Circuit Protected	Amps
18	Power Tailgate Closer *	(20 A)
19	ACC	7.5 A
20	ACC Key Lock	7.5 A
21	Daytime Running Lights	7.5 A
22	A/C	7.5 A
23	Wiper/Washer RLY	10 A
24	ABS/VSA * ¹ Relay 2 * ²	7.5 A
25	Backup FI ECU I/S APD* ² Audio* ¹	(7.5 A) (10 A)
26	Super Locking *	(20 A)
27	Accessory Power Socket (Front Console)	20 A
28	Washer *	(15 A)
29	SRS2	7.5 A
30	Driver's Door Lock Motor (Lock)	10 A
31	Smart *	(10 A)
32	Passenger's Side Door Lock Motor (Lock)	15 A
33	Driver's Door Lock Motor (Lock)	15 A
34	Position Lights	10 A

	Circuit Protected	Amps
35	Illumination	7.5 A
36	Rear Wiper Main *	(10 A)
37	Corner Light *	(15 A)
38	Left Headlight High Beam	10 A
39	Right Headlight High Beam	10 A
40	Rear Fog Light	7.5 A
41	Door Lock	20 A
42	Driver's Power Window	20 A
43	Rear Right Side Power Window	20 A
44	Front Passenger's Side Power Window	20 A
45	Rear Left Side Power Window	20 A
46	Starter* Front Wiper*	20 A 30 A
47	Starter Cut RLY*	7.5 A
48	VSA UB ECU Back Up*	7.5 A
49	Front Sensor Camera*	7.5 A
50	Starter Cut*	7.5 A
51	MG Diode*	7.5 A

*1: Models without Auto Idle Stop

*2: Models with Auto Idle Stop

Passenger Side Interior Fuse Box*

Fuse locations are shown on the image below.

Locate the fuse in question by the fuse number in the image and chart.

Left Handle Models

Located near the lower side panel.

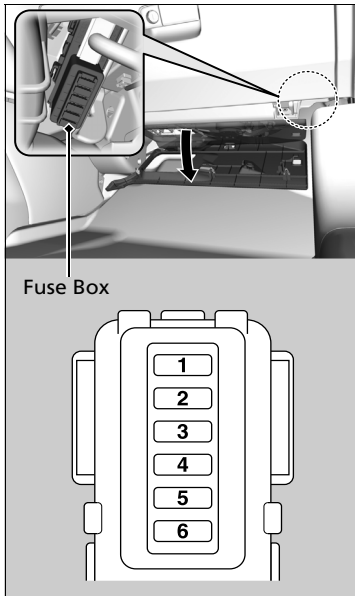

* Not available on all models

Right Handle Models

Located the back side of the dashboard.

► How to pivot the glove box P. 592

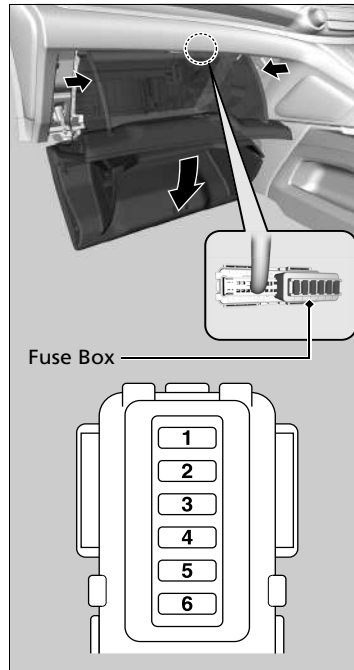

■ Circuit protected and fuse rating

	Circuit Protected	Amps
1	Meter	7.5 A
2	VSA/ABS	7.5 A
3	MICU	7.5 A
4	Audio Amp	20 A
5	ACC Radio	7.5 A
6	Back Up 2 Main	20 A

Inspecting and Changing Fuses

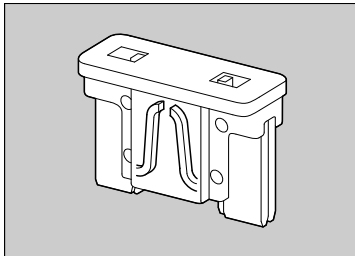
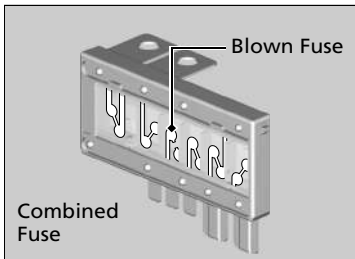

1. Turn the ignition switch to LOCK [0]^{*1}. Turn headlights and all accessories off.
2. Remove the fuse box cover.
3. Check the large fuse in the engine compartment.
 - If the fuse is blown, use a Phillips-head screwdriver to remove the screw and replace it with a new one.
4. Inspect the small fuses in the engine compartment and the vehicle interior.
 - If there is a burned out fuse, remove it and replace it with a new one.

► Inspecting and Changing Fuses

NOTICE

Replacing a fuse with one that has a higher rating greatly increases the chances of damaging the electrical system.

Replace fuse with a new one of the same specified amperage.

Use the charts to locate the fuse in question and confirm the specified amperage.

► **Fuse Locations** P. 639

*1: Models with the keyless access system have an **ENGINE START/STOP** button instead of an ignition switch.

Emergency Towing

Call a professional towing service if you need to tow your vehicle.

All Models

■ Flat bed equipment

The operator loads your vehicle on the back of a truck.

This is the best way to transport your vehicle.

2WD Models

■ Wheel lift equipment

The tow truck uses two pivoting arms that go under the front tyres and lift them off the ground. The rear tyres remain on the ground. **This is an acceptable way to tow your vehicle.**

Emergency Towing

NOTICE

Trying to lift or tow your vehicle by the bumpers will cause serious damage. The bumpers are not designed to support the vehicle's weight.

NOTICE

Improper towing such as towing behind a motorhome or other motor vehicle can damage the transmission.

Never tow your vehicle with just a rope or chain. It is very dangerous since ropes or chains may shift from side to side or break.

Continued

Models without AWD system

Models without 9-speed automatic transmission

■ If your vehicle must be towed with the front wheels on the ground:



1. Check the transmission fluid level.
 - ▶ **Transmission Fluid** P. 558
2. Hook the towing device to the towing hook.
3. Start the engine.
 - ▶ If it is difficult to turn on the engine, put the ignition switch in ACCESSORY **I** or ON **II***1.

Automatic transmission models

4. Shift to **D** and hold for five seconds, then to **N**.

Manual transmission models

4. Shift to **N**.

All models

5. Release the parking brake.

▶▶ If your vehicle must be towed with the front wheels on the ground:

Towing a vehicle is prohibited by law in some countries. Check and follow the legal requirements of the country you are driving before towing your vehicle.

If you cannot follow the exact procedure, do not tow your vehicle with the front wheels on the ground.

If you cannot turn on the engine, you may experience the following while your vehicle is being towed.

- Braking may become difficult since the brake system's power assist is disabled.
- Steering wheel becomes heavy as the power steering system is disabled.

Manual transmission models

- Turning the ignition switch to LOCK **0***1 locks the steering wheel.

Going down a long slope heats up the brakes. This may prevent the brakes from working properly. If your vehicle needs to be towed on an incline, call a professional towing service.

With the front wheels on the ground, it is best to tow the vehicle no farther than 80 km (50 miles), and keep the speed below 55 km/h (34 mph).

*1: Models with the keyless access system have an **ENGINE START/STOP** button instead of an ignition switch.

When You Cannot Open the Tailgate

When You Cannot Open the Tailgate

If you cannot open the tailgate, use the following procedure.

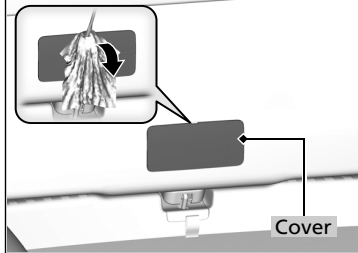

1. Use a flat-tip screwdriver and remove the cover on the back of the tailgate.
 - ▶ Wrap the flat-tip screwdriver with a cloth to prevent scratches.

Models with power tailgate

2. To open the tailgate, push the tailgate while pushing the lever to the right.

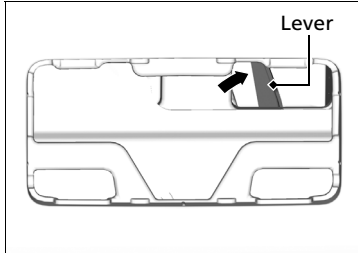

Models without power tailgate

2. To open the tailgate, push the tailgate while pushing down the lever with the flat-tip screw driver.

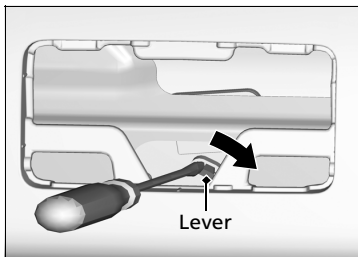

When You Cannot Open the Tailgate

After taking these steps, contact a dealer to have the vehicle checked.

When you open the tailgate from inside, make sure there is enough space around the tailgate, and it does not hit anyone or any object.

Diesel models

Refueling From a Portable Fuel Container

If you have run out of fuel and need to refuel your vehicle from a portable fuel container, use the funnel provided with your vehicle.

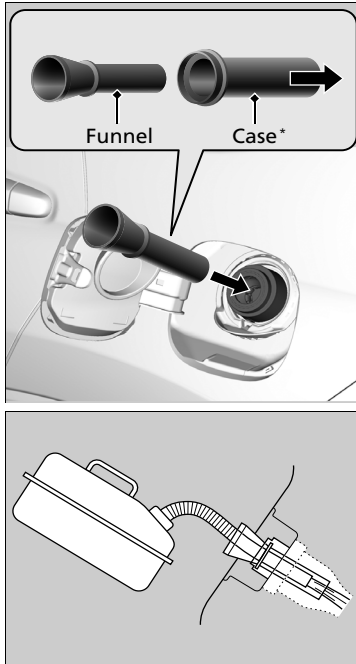

1. Turn off the engine.
2. Pull on the fuel fill door release handle under the lower left/right corner of the dashboard.
 - ▶ The fuel fill door opens.
3. Take the funnel out of the tool case in the luggage area.
 - ▶ **Types of Tools** P. 602
4. Remove the funnel from the case.
5. Insert the funnel into the filler neck fully and slowly.
6. Fill the tank with fuel from the portable fuel container.
 - ▶ Pour fuel carefully so you do not spill any.
7. Remove the funnel from the filler neck.
 - ▶ Wipe up any fuel from the funnel before storing it.
8. Shut the fuel fill door by hand.

▶ Refueling From a Portable Fuel Container

WARNING

Fuel is highly flammable and explosive. You can be burned or seriously injured when handling fuel.

- Stop the engine, and keep heat, sparks, and flame away.
- Handle fuel only outdoors.
- Wipe up spills immediately.

NOTICE

Do not insert the nozzle of a portable fuel container or any funnel other than the one provided with your vehicle. Doing so can damage the fuel system.

Do not try to pry open or push open the sealed fuel tank with foreign objects. This can damage the fuel system and its seal.

Make sure the fuel in the portable fuel container is diesel fuel before you refuel.

Information

This chapter includes your vehicle's specifications, locations of identification numbers, and other information required by regulation.

Specifications	652
Identification Numbers	
Vehicle Identification Number (VIN), Engine Number and Transmission Number	658
Devices that Emit Radio Waves*	659
EC Declaration of Conformity Content Outline*	661

* Not available on all models

Petrol models

Vehicle Specifications

Model	CR-V		
Curb Weight	MT	1,460-1,519 kg (3,219-3,349 lbs) ^{*1} 1,521-1,619 kg (3,353-3,569 lbs) ^{*2}	
	AT	1,543-1,645 kg (3,402-3,627 lbs)	
Maximum Permissible Weight	MT	1,965 kg (4,332 lbs) ^{*1} 2,075 kg (4,575 lbs) ^{*2}	
	AT	2,100 kg (4,630 lbs)	
Maximum Permissible Axle Weight	MT	Front	1,005 kg (2,216 lbs) ^{*1} 1,040 kg (2,293 lbs) ^{*2}
		Rear	980 kg (2,161 lbs) ^{*1} 1,055 kg (2,326 lbs) ^{*2}
	AT	Front	1,065 kg (2,348 lbs)
		Rear	1,055 kg (2,326 lbs)

*1: 2WD models

*2: AWD models

Engine Specifications

Type	Water cooled 4-stroke SOHC i-VTEC in line, 4-cylinder petrol engine
Bore x Stroke	81 x 96.9 mm (3.19 x 3.81 in)
Displacement	1,997 cm ³ (122 cu-in)
Compression Ratio	10.6 : 1
Spark Plugs	NGK DILZKR7B11GS
	DENSO DXU22HCR-D11S

Fuel

Fuel:	Unleaded premium petrol, Research octane number of 95 or higher
Type	
Fuel Tank Capacity	58 ℓ

Battery

Capacity/Type	48AH(5)/60AH(20)
---------------	------------------

Washer Fluid

Tank Capacity	4.5 ℓ ^{*1}
	4.8 ℓ ^{*2}

*1: Vehicle with 18 inch wheel

*2: Vehicle with 17 inch wheel

Light Bulbs

Headlights (Low Beam)	35 W (D4S) ^{*1}
	55 W (H11) ^{*2}
Headlights (High Beam)	60 W (HB3)
Front Fog Lights ^{*3}	35 W (H8)
Front Turn Signal Lights	21 W (Amber)
Active Cornering Lights ^{*1}	LED
Daytime Running Lights	LED
Position Lights	LED
Side Turn Signal Lights (on Door Mirrors)	LED
Brake/Tail-lights	LED
Taillights	LED
Rear Turn Signal Lights	21 W (Amber)
Back-Up Lights	21 W
Rear Fog Light	21 W
High-Mount Brake Light	LED
Rear Licence Plate Lights	5 W
Interior Lights	
Map Lights	8 W
Ceiling Light	8 W
Door Courtesy Lights ^{*1}	LED
Foot Light ^{*1}	LED
Vanity Mirror Lights ^{*3}	2 W
Luggage Area Light	8 W
Glove Box Light ^{*3}	3.4 W

*1: Vehicle with 18 inch wheel

*2: Vehicle with 17 inch wheel

*3: Vehicle with front fog light

■ Brake/Clutch Fluid*

Specified	Brake Fluid with DOT 3 or DOT 4
-----------	---------------------------------

■ Automatic Transmission Fluid*

Specified	Honda ATF DW-1 (automatic transmission fluid)
Capacity	Change 2.6 ℓ

■ Manual Transmission Fluid*

Specified	Honda Manual Transmission Fluid
Capacity	Change 1.9 ℓ ^{*1} 2.2 ℓ ^{*2}

*1: 2WD models

*2: AWD models

■ Engine Oil

Recommended	European models with service reminder system
	Honda Green Oil ACEA A3/B3, A5/B5 or higher grade 0W-20
	European models without service reminder system
	Honda Genuine Motor Oil ACEA A1/B1, A3/B3, A5/B5 or higher grade 0W-20
Capacity	Except European models
	Honda Genuine Motor Oil API service SM or higher grade 0W-20, 0W-30, 0W-40, 5W-30, 5W-40, 10W-30, 10W-40
	Change 3.5 ℓ Change including filter 3.7 ℓ

■ Rear Differential Fluid*

Specified	Honda Dual Pump Fluid II
Capacity	Total 1.488 ℓ
	Change 1.247 ℓ

■ Engine Coolant

Specified	Honda All Season Antifreeze/Coolant Type2
Ratio	50/50 with distilled water
Capacity	6.03 ℓ (change including the remaining 0.62 ℓ in the reserve tank) ^{*1, *3}
	5.93 ℓ (change including the remaining 0.62 ℓ in the reserve tank) ^{*1, *4}
	6.04 ℓ (change including the remaining 0.62 ℓ in the reserve tank) ^{*2, *3}
	5.94 ℓ (change including the remaining 0.62 ℓ in the reserve tank) ^{*2, *4}

*1: Right-hand drive type

*2: Left-hand drive type

*3: Automatic transmission models

*4: Manual transmission models

■ Tyre

Regular	Size	225/65R17 102H 225/60R18 100H
	Pressure	See the label on driver's doorjamb
Compact Spare ^{*1}	Size	T155/90D17 101M
	Pressure kPa (bar [psii])	420 (4.2 [60])
Wheel Size	Regular	17 x 7J 18 x 7J
	Compact Spare ^{*1}	17 x 4T

*1: Vehicle with compact spare tyre

■ Honda TRK Air Compressor

A weighted emission sound pressure level	80 ± 5 dB (A)
A weighted sound power level	91.5 ± 5 dB (A)

■ Brake

Type	Power assisted
Front	Ventilated disc
Rear	Disc
Parking	Mechanical

■ Air Conditioning*

Refrigerant Type	HFC-134a (R-134a) ^{*1, *3}
	HFO-1234yf (R-1234yf) ^{*2, *4}
Charge Quantity	415 – 465 g ^{*1, *2}
	385 – 435 g ^{*3}
	395 – 445 g ^{*4}

*1: Right-hand drive type with HFC-134a (R-134a)

*2: Right-hand drive type with HFO-1234yf (R-1234yf)

*3: Left-hand drive type with HFC-134a (R-134a)

*4: Left-hand drive type with HFO-1234yf (R-1234yf)

* Not available on all models

■ Vehicle Dimensions

Length	4,605 mm (181.2 in)
Width	1,820 mm (71.6 in)
Height	1,670 mm (65.7 in) ^{*1}
	1,680 mm (66.1 in) ^{*2}
Wheelbase	2,630 mm (103.5 in)
Track	Front 1,585 mm (62.4 in)
	Rear 1,595 mm (62.7 in) ^{*1}
	1,590 mm (62.5 in) ^{*2}

*1: 2WD models
*2: AWD models

■ The mounting point/rear over hang of coupling device

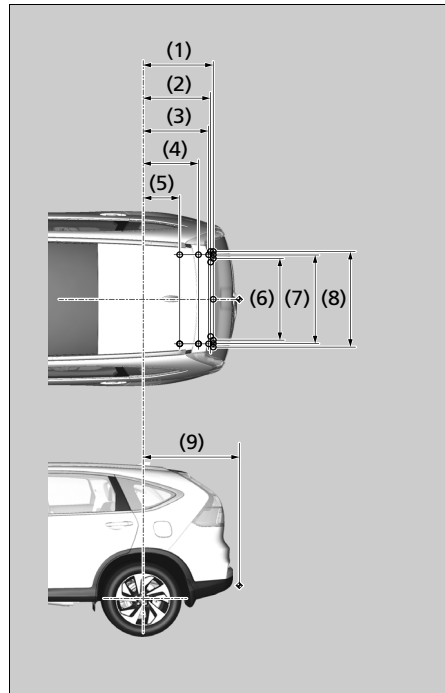

NOTE:

- marks show towbar fixing points.
- ↔ mark shows towbar coupling point.

No.	Dimensions
(1)	787 mm (30.9 in)
(2)	758 mm (29.8 in)
(3)	736 mm (28.9 in)
(4)	621 mm (24.4 in)
(5)	408 mm (16.1 in)
(6)	956 mm (37.6 in)
(7)	1,037 mm (40.8 in)
(8)	1,120 mm (44.1 in)
(9)	1,080 mm (42.5 in)

■ Max. Towing Weight

Trailer with brakes	Manual Transmission Models	1,700 kg (3,748 lbs)
	Automatic Transmission Models	1,500 kg (3,307 lbs)
Trailer without brakes	Manual Transmission Models	600 kg (1,323 lbs)
	Automatic Transmission Models	600 kg (1,323 lbs)
The maximum permissible vertical load on the coupling device		100 kg (220 lbs)

Diesel models

Vehicle Specifications

Model	CR-V	
Curb Weight	MT	1,545-1,594 kg (3,406-3,514 lbs) ^{*1} 1,630-1,718 kg (3,593-3,788 lbs) ^{*2}
	AT	1,658-1,724 kg (3,655-3,801 lbs)
Maximum Permissible Weight	MT	2,100 kg (4,630 lbs) ^{*1}
	AT	2,170 kg (4,784 lbs) ^{*2}
Maximum Permissible Axle Weight	Front	1,100 kg (2,425 lbs) ^{*1} 1,170 kg (2,579 lbs) ^{*2}
	Rear	1,055 kg (2,326 lbs)

*1: 2WD models

*2: AWD models

Engine Specifications

Type	Water cooled 4-stroke DOHC i-DTEC diesel engine with turbo charger, intercooler
Bore x Stroke	76.0 x 88.0 mm (2.99 x 3.46 in)
Displacement	1,597 cm ³ (97 cu-in)
Compression Ratio	16.0 : 1

Fuel

Fuel:	EN 590 standard diesel fuel ^{*1}
Type	Diesel fuel with sulfur less 50ppm only ^{*2}
Fuel Tank Capacity	58 ℓ

*1: Except Ukraine models

*2: Ukraine models

Battery

Capacity/Type	56AH(5)/70AH(20)
---------------	------------------

Washer Fluid

Tank Capacity	4.5 ℓ ^{*1}
	4.8 ℓ ^{*2}

*1: Vehicle with 18 inch wheel

*2: Vehicle with 17 inch wheel

Light Bulbs

Headlights (Low Beam)	35 W (D4S) ^{*1}
	55 W (H11) ^{*2}
Headlights (High Beam)	60 W (HB3)
Front Fog Lights ^{*3}	35 W (H8)
Front Turn Signal Lights	21 W (Amber)
Active Cornering Lights ^{*1}	LED
Daytime Running Lights	LED
Position Lights	LED
Side Turn Signal Lights (on Door Mirrors)	LED
Brake/Tail-lights	LED
Taillights	LED
Rear Turn Signal Lights	21 W (Amber)
Back-Up Lights	21 W
Rear Fog Light	21 W
High-Mount Brake Light	LED
Rear Licence Plate Lights	5 W
Interior Lights	
Map Lights	8 W
Ceiling Light	8 W
Door Courtesy Lights ^{*1}	LED
Foot Light ^{*1}	LED
Vanity Mirror Lights ^{*3}	2 W
Luggage Area Light	8 W
Glove Box Light ^{*3}	3.4 W

*1: Vehicle with 18 inch wheel

*2: Vehicle with 17 inch wheel

*3: Vehicle with front fog light

■ Brake/Clutch Fluid*

Specified	Brake Fluid with DOT 3 or DOT 4
-----------	---------------------------------

■ Automatic Transmission Fluid*

Specified	Honda ATF-TYPE 3.0 (automatic transmission fluid)	
Capacity	Change	3.3 ℓ

■ Manual Transmission Fluid*

Specified	Honda Manual Transmission Fluid	
Capacity	Change	1.8 ℓ ^{*1}
		2.5 ℓ ^{*2}

*1: 2WD models

*2: AWD models

■ Engine Oil

Recommended	European and Ukraine models	
	Honda Diesel Oil #1.0 ACEA C2/C3 0W-30	
	Except European and Ukraine models	
	Honda Diesel Oil #1.0 ACEA C2/C3 0W-30, 5W-30	
Capacity	Change	4.3 ℓ ^{*1}
		4.5 ℓ ^{*2}
Capacity	Change	4.7 ℓ ^{*1}
	including filter	4.9 ℓ ^{*2}

*1: 2WD models

*2: AWD models

■ Rear Differential Fluid*

Specified	Honda Dual Pump Fluid II	
Capacity	Total	1.488 ℓ
	Change	1.247 ℓ

■ Transfer Assembly Fluid*¹

Specified	SAE 75W-85	
Capacity	Change	0.41 ℓ

*1: Automatic transmission models

■ Engine Coolant

Specified	Honda All Season Antifreeze/Coolant Type2	
Ratio	50/50 with distilled water	
Capacity	5.65 ℓ (change including the remaining	
	0.59 ℓ in the reserve tank)	

■ Tyre

Regular	Size	225/65R17 102H
		225/60R18 100H
Compact Spare ^{*1}	Pressure	See the label on driver's doorjamb
	Size	T155/90D17 101M
Wheel Size	Regular	17 x 7J
	Compact Spare ^{*1}	17 x 4T

*1: Vehicle with compact spare tyre

■ Honda TRK Air Compressor

A weighted emission sound pressure level	80 ± 5 dB (A)
A weighted sound power level	91.5 ± 5 dB (A)

■ Brake

Type	Power assisted
Front	Ventilated disc
Rear	Disc
Parking	Mechanical

■ Air Conditioning*

Refrigerant Type	HFC-134a (R-134a) ^{*1, *3}
	HFO-1234yf (R-1234yf) ^{*2, *4}
Charge Quantity	415 – 465 g ^{*1, *2}
	385 – 435 g ^{*3}
	395 – 445 g ^{*4}

*1: Right-hand drive type with HFC-134a (R-134a)

*2: Right-hand drive type with HFO-1234yf (R-1234yf)

*3: Left-hand drive type with HFC-134a (R-134a)

*4: Left-hand drive type with HFO-1234yf (R-1234yf)

■ Vehicle Dimensions

Length	4,605 mm (181.2 in)	
Width	1,820 mm (71.6 in)	
Height	1,670 mm (65.7 in) ^{*1}	
	1,680 mm (66.1 in) ^{*2}	
Wheelbase	2,630 mm (103.5 in)	
Track	Front	1,585 mm (62.4 in)
	Rear	1,595 mm (62.7 in) ^{*1}
		1,590 mm (62.5 in) ^{*2}

*1: 2WD models
*2: AWD models

■ The mounting point/rear over hang of coupling device

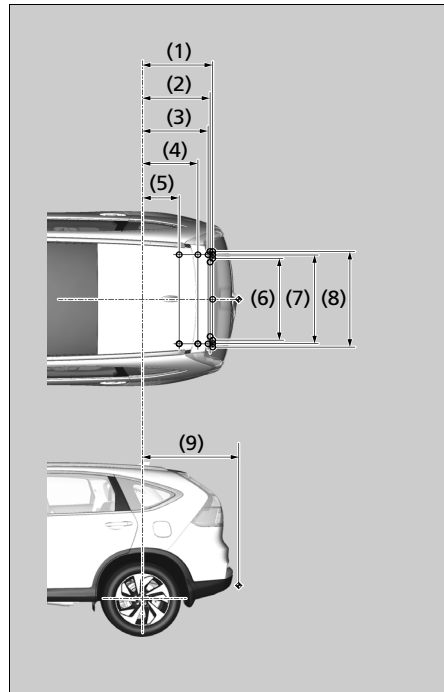

NOTE:

1. ○ marks show towbar fixing points.
2. ➔ mark shows towbar coupling point.

No.	Dimensions
(1)	787 mm (30.9 in)
(2)	758 mm (29.8 in)
(3)	736 mm (28.9 in)
(4)	621 mm (24.4 in)
(5)	408 mm (16.1 in)
(6)	956 mm (37.6 in)
(7)	1,037 mm (40.8 in)
(8)	1,120 mm (44.1 in)
(9)	1,080 mm (42.5 in)

■ Max. Towing Weight

Trailer with brakes	Manual Transmission Models	1,700 kg (3,748 lbs) ^{*1}
	Automatic Transmission Models	2,000 kg (4,409 lbs) ^{*2}
Trailer without brakes	Manual Transmission Models	600 kg (1,323 lbs)
	Automatic Transmission Models	600 kg (1,323 lbs)
The maximum permissible vertical load on the coupling device		100 kg (220 lbs)

*1: 2WD models
*2: AWD models

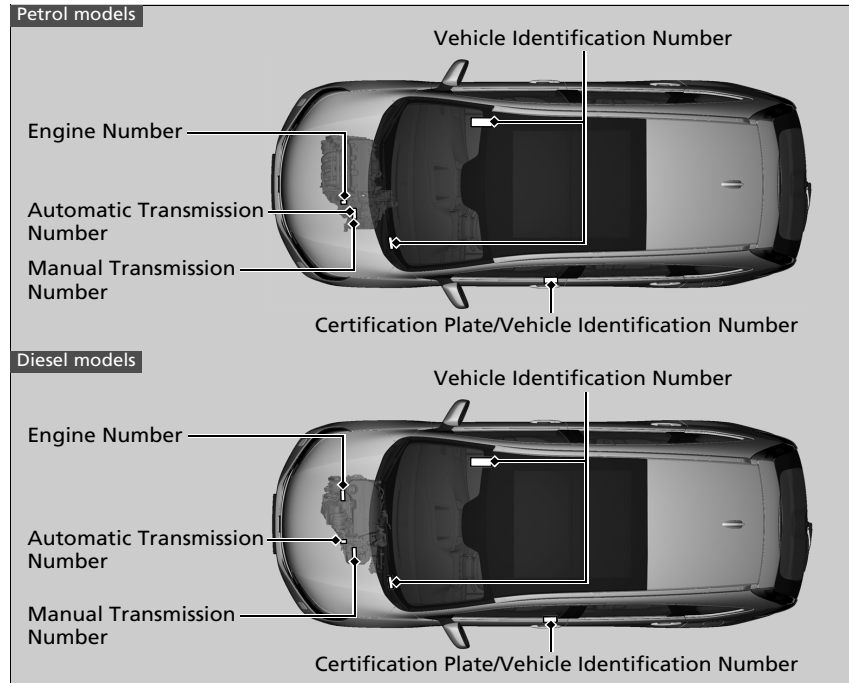

Vehicle Identification Number (VIN), Engine Number and Transmission Number

Your vehicle has a 17-digit vehicle identification number (VIN) used to register your vehicle for warranty purposes, and for licensing and insuring your vehicle. The locations of your vehicle's VIN, engine number and transmission number are shown as follows.



Devices that Emit Radio Waves*

The following products and systems on your vehicle emit radio waves when in operation.

Remote Transmitter*	Immobilizer System	Keyless Access System*
		

* Not available on all models

▶ Devices that Emit Radio Waves*

European models

Models with remote transmitter

Models with keyless access system

EC Directives

Each of the items in the table complies with the essential requirements and other relevant provisions of R & TTE (Radio equipment and Telecommunications Terminal Equipment and the mutual recognition of their conformity) Directive 1999/5/EC.

See the following URLs for Declaration of conformity:
<http://www.techinfo.honda-eu.com>

Continued

Hands-Free Telephone
System*



▶▶ Devices that Emit Radio Waves*

European models

Models with Hands-Free Telephone System

EC Directives

Each of the items in the table complies with the essential requirements and other relevant provisions of R & TTE (Radio equipment and Telecommunications Terminal Equipment and the mutual recognition of their conformity) Directive 1999/5/EC.

See the following URLs for Declaration of conformity:

<http://www.techinfo.honda-eu.com>



DECLARATION OF “CE” CONFORMANCE

EC Declaration of Conformity

1. The undersigned, Mr. Tony Fabiano, representing the manufacturer, herewith declares that the machinery described below fulfils all the relevant provisions of:

- Directive 2006/42/EC, on Machinery

2. Description of the machinery

- a) Part Name: Jack Assembly
 b) Function: lifting motor vehicle

c) Model	d) Type	e) Serial Number
SWW	Honda Type E	Not applicable

3. Manufacturer:

Flex-N-Gate / Ventra, 75 Reagens Industrial Court, RR # 1 Bradford, ON, Canada L4A 2Z4

4. Person authorised to compile the technical file:

Joan Grifoll
 Product Engineer
 FNG - BARCELONA
 Avda de la Riera, 7-9
 Sant Just Desvern, Barcelona
 Spain 08960

5. Applicable Harmonizing Standards:

EN1494:2000+A1:2008

6. Other Standards or Specifications:

None

7. Done at:

Bradford, OntarioCanada

8. Date:

May-13-13

Tony Fabiano
 Director of Engineering
 Flex-N-Gate/Ventra
 Bradford Product Development Centre

- A**
- ABS (Anti-lock Brake System)..... 490
 - ACC (Adaptive Cruise Control)..... 441
 - Accessories and Modifications..... 599
 - Accessory Power Sockets..... 225
 - Active Cornering Lights..... 191
 - Adaptive Cruise Control (ACC)..... 441
 - Adaptive Cruise Control (ACC) Indicator... 98
 - Adding
 - Coolant..... 553, 556
 - Engine Oil..... 552
 - Washer..... 561
 - Additives, Engine Oil..... 547
 - Adjustable Speed Limiter..... 435
 - Adjusting
 - Front Seats..... 210
 - Head Restraints..... 213
 - Headlights..... 193, 564
 - Mirrors..... 206
 - Rear Seats..... 217
 - Steering Wheel..... 205
 - Temperature..... 131
 - Air Conditioning System (Climate Control System)
 - Defrosting the Windscreen and Windows..... 235
 - Dust and Pollen Filter..... 592
 - Recirculation/Fresh Air Mode..... 235
 - Sensors..... 238
 - Air Pressure..... 653, 656
 - Airbags..... 49
 - After a Collision..... 52
 - Airbag Care..... 61
 - Event Data Recorder..... 30
 - Front Airbags (SRS)..... 51
 - Indicator..... 59, 90
 - Passenger Front Airbag Off Indicator..... 60
 - Sensors..... 49
 - Side Airbags..... 56
 - Side Curtain Airbags..... 58
 - All-Wheel Drive (AWD) System..... 486
 - AM/FM Radio..... 249
 - Anti-lock Brake System (ABS)..... 490
 - Indicator..... 90
 - Armrest..... 219
 - Audio Remote Controls..... 245
 - Audio System..... 240
 - Adjusting the Sound..... 248, 287
 - Auxiliary Input Jack..... 243
 - Error Messages..... 315
 - General Information..... 319
 - MP3/WMA/AAC..... 259, 265, 302
 - Reactivating..... 244
 - Recommended CDs..... 319
 - Recommended Devices..... 320
 - Remote Controls..... 245
 - Security Code..... 244
 - Theft Protection..... 244
 - USB Adapter Cable..... 241
 - USB Flash Drives..... 320
 - USB Port(s)..... 242
 - Auto Idle Stop..... 423, 427
 - OFF Button..... 423
 - Auto Idle Stop Indicator..... 107
 - Auto Idle Stop System Indicator..... 107
 - Automatic Transmission..... 405
 - Creeping..... 405
 - Fluid..... 558
 - Kickdown..... 405
 - Operating the Shift Lever..... 19, 406, 407
 - Sequential Shift Mode..... 408
 - Shift Lever Does Not Move..... 628
 - Shifting..... 406
 - Auxiliary Input Jack..... 243
 - Average Fuel Economy..... 131, 144
 - Average Speed..... 132, 144
 - AWD (All-Wheel Drive)..... 486
- B**
- Battery..... 585
 - Charging System Indicator..... 86, 633
 - Jump Starting..... 625
 - Maintenance (Checking the Battery)..... 585
 - Maintenance (Replacing)..... 586
 - Belts (Seat)..... 39
 - Beverage Holders..... 223
 - Blind Spot Information System..... 481
 - Bluetooth® Audio..... 268
 - Booster Seats (For Children)..... 79
 - Brake System..... 487
 - Anti-lock Brake System (ABS)..... 490

Brake Assist System.....	491	Carrying Luggage.....	385, 387	CMBS (Collision Mitigation Braking System).....	493
Emergency Stop Signal.....	492	CD Player.....	259	Coat Hook.....	228
Fluid.....	560	Certification Label.....	658	Collision Mitigation Brake System (CMBS) Indicator.....	98
Foot Brake.....	488	Changing Bulbs.....	564	Collision Mitigation Braking System (CMBS).....	493
Indicator.....	84, 634	Charging System Indicator.....	86, 633	Compact Spare Tyre.....	603, 653, 656
Parking Brake.....	487	Child Restraint System.....	62	Console Compartment.....	222
Brightness Control (Instrument Panel) ...	201	Booster Seats.....	79	Controls	155
Bulb Replacement	564	Child Restraint System for Infants.....	65	Coolant (Engine)	553, 556
Back-Up Light.....	569	Child Restraint System for Small Children...	67	Adding to the Expansion Tank.....	557
Brake/Tail-Light.....	570	Installing a Child Restraint System with a Lap/Shoulder Seat Belt.....	74	Adding to the Radiator.....	555
Ceiling Light.....	574	Larger Children.....	78	Adding to the Reserve Tank.....	554
Daytime Running Lights.....	565	Rearward Facing Child Restraint System....	65	Overheating.....	631
Fog Lights.....	567	Selecting a Child Restraint System.....	68	Creeping (Automatic Transmission).....	405
Front Turn Signal Light.....	566	Using Tether.....	76	Cross Traffic Monitor	513
Glove Box Light.....	575	Child Safety	62	Cruise Control	431
Headlights.....	564	Childproof Door Locks.....	168	Cup Holders	223
High-Mount Brake Light.....	571	City-Brake Active System	502	Customized Features	133, 145, 323
Interior Lights.....	574	Cleaning the Exterior	596		
Luggage Light.....	575	Cleaning the Interior	594		
Map Light.....	574	Climate Control System	234		
Position Light.....	565	Changing the Mode.....	234		
Rear Fog Light.....	572	Defrosting the Windscreen and Windows.....	235		
Rear Licence Plate Light.....	571	Dust and Pollen Filter.....	592		
Rear Turn Signal Light.....	569	Recirculation/Fresh Air Mode.....	235		
Side Turn Signal Light.....	567	Sensors.....	238		
Vanity Mirror.....	574	Using Automatic Climate Control.....	234		
Bulb Specifications	652, 655	Clock	156		
		Clutch Fluid	560		
C				D	
Carbon Monoxide Gas.....	81			Daytime Running Lights.....	196
				Dead Battery.....	625
				Deflation Warning System.....	484
				Calibration.....	484
				Indicator.....	93
				Defrosting the Windscreen and Windows.....	235
				Devices that Emit Radio Waves.....	659

Diesel	24, 523
Diesel Particulate Filter (DPF)	562
Dimming	
Headlights	189
Dipstick (Engine Oil)	550
Directional Signals (Turn Signals)	189
Display Button	143, 272
Door Mirrors	208
Doors	158
Door and Tailgate Open Indicator	94
Keys	158
Locking/Unlocking the Doors from the Inside	167
Locking/Unlocking the Doors from the Outside	161
Lockout prevention system	165
Driving	383
Automatic Transmission	405
Braking	487
Cruise Control	431
Shifting Gear	406, 411, 420
Starting the Engine	397, 400
Dust and Pollen Filter	592

E

Eco Assist System	9
ECON Button	430
Elapsed Time	132, 144
Electric Power Steering (EPS) System	
Indicator	93, 635

Emergency	647
Emergency Parking Release	629
Emergency Stop Signal	492
Engine	658
Coolant	553, 556
Jump Starting	625
Oil	547
Starting	397, 400
Switch Buzzer	184
Engine Coolant	553, 556
Adding to the Expansion Tank	557
Adding to the Radiator	555
Adding to the Reserve Tank	554
Overheating	631
Engine Oil	547
Adding	552
Checking	550
Low Oil Level Indicator	637
Low Oil Pressure Indicator	85, 633
Recommended Engine Oil	547
ENGINE START/STOP Button	185
e-pretensioners	42
EPS (Electric Power Steering)	
System	93, 635
Exhaust Hazard (Carbon Monoxide)	81
Exterior Care (Cleaning)	596
Exterior Mirrors	208

F

Features	239
----------	-----

Filter	
Dust and Pollen	592
Fuel	561
Flat Tyre	603
Floor Mats	595
Fluids	
Automatic Transmission	558
Brake/Clutch	560
Engine Coolant	553, 556
Manual Transmission	559
Windscreen Washer	561
Folding Down the Rear Seats	217
Foot Brake	488
Forward Collision Warning	455
Indicator	100
Front Airbags (SRS)	51
Front Fog Light Indicator	96
Front Seats	
Adjusting	210
Front Sensor Camera	439
Fuel	522
Economy	526
Gauge	128
Instant Fuel Economy	131
Low Fuel Indicator	89
Range	132, 144
Recommendation	522, 523
Refueling	522
Fuel Economy	526
Fuel Fill Cap	23, 524
Fuel Fill Door	23, 24, 524, 525

Fuses	639	Menus	342, 367	Vehicle Identification	658
Inspecting and Changing	646	Options During a Call	363, 381	Ignition Switch	184
Locations	639, 642, 643, 645	Phone Setup	346, 370	Illumination Control	
G		Receiving a Call	362, 381	Knob.....	201
Gauges	128	Ring Tone	374	Immobilizer System	176
Gear Position Indicator	88	Speed Dial	355, 376	Indicator.....	96
Gear Shift Lever Positions		To Clear the System	353	i-Multi-Information Display	143
5-speed automatic Transmission	406	To Create a Security PIN	351		
9-speed automatic transmission	411	Hazard Warning Button	2, 3		
Manual Transmission	420	HDMI™ Port	243		
Glass (care)	597	Head Restraints	213		
Glove Box	222	Headlights	189		
Glow Plugs Indicator	89	Active Cornering Lights	191		
		Adjuster	193		
		Aiming	564		
		Automatic Operation	190		
		Dimming	189		
		High Beam Support	194		
		Operating.....	189		
		Heated Door Mirrors	202		
		Heaters (Seat)	231		
		HFT (Hands-Free Telephone)	340, 364		
		High Beam Indicator	95		
		High Beam Support System	194		
		High Beam Support System Indicator	103		
		Honda TRK	611		
		I			
		Identification Numbers			
		Engine and Transmission	658		

Indicators	84	Parking Brake and Brake System.....	84	Types and Functions.....	158
Adaptive Cruise Control (ACC)	98	Passenger Front Airbag On/Off	91	Won't turn.....	27
All-Wheel Drive (AWD) System.....	94	Rear Fog Light	96	Kickdown (Automatic Transmission)	405
Anti-lock Brake System (ABS).....	90	Seat Belt Reminder.....	88		
Auto Idle Stop	107	Security System Alarm	97	L	
Auto Idle Stop System.....	107	Shift Lever Position	86	Lane Departure Warning	459
Blind Spot Information.....	483	Shift Up/Down	97	Button	460
Charging System	86	Supplemental Restraint System.....	90	Lane Keeping Assist System (LKAS)	470
Collision Mitigation Brake System		System Message.....	95	Indicator	103
(CMBS).....	98	Transmission	86	Language (HFT).....	341, 366
Cruise Main.....	431, 432	Turn Signal.....	95	Light Switches	189
Door and Tailgate Open.....	94	Vehicle Stability Assist (VSA)	92	Lights	189, 564
ECON Mode	97	VSA OFF.....	92, 479	Automatic.....	190
Electric Power Steering (EPS).....	93	Information Button.....	129	Bulb Replacement	564
Front Fog Light	96	Instrument Panel.....	83	Daytime Running Lights	196
Gear Position	88	Brightness Control.....	201	Fog Lights	192
Glow Plugs	89	Interior Lights	220	High Beam Indicator Light.....	95
Hazard Warning	95	Interior Rearview Mirror.....	206	High Beam Support System Indicator	103
High Beam.....	95			Interior.....	220
High Beam Support System.....	103	J		Lights On Indicator.....	96
Hill Descent Control System	92	Jump Starting	625	Turn Signals.....	189
Immobilizer System.....	96			LKAS (Lane Keeping Assist System)	470
Keyless Access System	97	K		Load Limit.....	387
Lane Keeping Assist System (LKAS) ..	103, 472	Key Number Tag.....	160	Locking/Unlocking	158
Lights On.....	96	Keys.....	158	Childproof Door Locks	168
Low Fuel.....	89	Lockout prevention	165	From Inside	167
Low Oil Pressure	85	Number Tag	160	From Outside	161
Low Tyre Pressure/Deflation Warning		Rear Door Won't Open.....	168	Keys.....	158
System.....	93	Remote Transmitter.....	161	Using a Key.....	165
M (Sequential Shift Mode).....	88			Lockout prevention system	165
Malfunction Indicator Lamp.....	85				

Low Battery Charge	633
Low Fuel Indicator	89
Low Oil Level	110
Low Oil Pressure Indicator	633
Lower Anchorages	71
Lubricant Specifications Chart	653, 656
Luggage	
Light Bulb	575
Luggage (Load Limit)	387
Luggage Hooks	229

M

M (Sequential Shift Mode) Indicator	88
Maintenance	527
Battery	585
Brake/Clutch Fluid	560
Cleaning	594
Climate Control	591
Coolant	553, 556
Oil	550
Precautions	528
Radiator	555
Remote Transmitter	589, 590
Replacing Light Bulbs	564
Safety	529
Transmission Fluid	558
Tyres	580
Under the Bonnet	544
Malfunction Indicator Lamp	85, 634
Manual Transmission	420

Map Lights	221
Maximum Permissible Weight	387
Meters, Gauges	128
Mirrors	206
Adjusting	206
Door	208
Exterior	208
Interior Rear View	206
Modifications (and Accessories)	599
MP3	259, 265, 302
Multi-Information Display	129
Multi-View Rear Camera	519

N

Numbers (Identification)	658
--------------------------------	-----

O

Odometer	130
Off-road Guidelines	395
Oil (Engine)	547
Adding	552
Checking	550
Low Oil Level Indicator	110, 637
Low Oil Pressure Indicator	85, 633
Recommended Engine Oil	547
Viscosity	547
Opening/Closing	
Bonnet	546
Power Windows	180

Sunshade	183
Tailgate	169
Outside Temperature Display	131
Overheating	631

P

Paddle Shifters (Sequential Shift Mode)	19, 408
Parking Brake	487
Parking Brake and Brake System Indicator	84, 634
Parking Sensor System	509
Passenger Front Airbag Off Indicator	60
Passing Indicators	189
Petrol	23, 522
Economy	526
Gauge	128
Information	522
Instant Fuel Economy	131
Low Fuel Indicator	89
Refueling	522
PGM-FI Symbol	122, 637
Playing Bluetooth® Audio	305
Precautions While Driving	
Rain	404
Pregnant Women	46
Puncture (Tyre)	603

- R**
- Radiator..... 555
 - Radio (AM/FM)..... 249
 - Radio (DAB)..... 255
 - Radio Data System (RDS)..... 250, 292
 - RDS (Radio Data System)..... 292
 - REAL TIME AWD with Intelligent Control System..... 486
 - Rear Demister/Heated Door Mirror Button..... 202
 - Rear Fog Light Indicator..... 96
 - Rear Seats (Folding Down)..... 217
 - Rearview Camera..... 518
 - Rearview Mirror..... 206
 - Refueling..... 522
 - Diesel..... 523, 655
 - Fuel Gauge..... 128
 - Low Fuel Indicator..... 89
 - Petrol..... 522, 652
 - Regulations..... 659
 - Remote Transmitter..... 161
 - Replacement
 - Battery..... 586
 - Bulbs..... 564
 - Fuses..... 639, 642, 643, 645
 - Tyres..... 603
 - Wiper Blade Rubber..... 576, 578
 - Resetting a Trip Meter..... 130
- S**
- Safe Driving..... 33
 - Safety Labels..... 82
 - Safety Message..... 31
 - Seat Belts..... 39
 - Adjusting the Shoulder Anchor..... 44
 - Checking..... 47
 - e-pretensioners..... 42
 - Fastening..... 43
 - Installing a Child Restraint System with a Lap/Shoulder Seat Belt..... 74
 - Pregnant Women..... 46
 - Reminder..... 41
 - Warning Indicator..... 41, 88
 - Seat Heaters..... 231
 - Seats..... 210
 - Adjusting..... 210
 - Front Seats..... 210
 - Rear Seats..... 217
 - Seat Heaters..... 231
 - Security System..... 176
 - Immobilizer System Indicator..... 96
 - Security System Alarm Indicator..... 97
 - SEL/RESET Button..... 129
 - Select Lever..... 406, 411, 420
 - Operation..... 406, 411, 420
 - Releasing..... 628
 - Won't Move..... 628
 - Selecting a Child Restraint System..... 68
 - Selector Knob (Audio)..... 247
 - Sequential Shift Mode..... 408
 - Setting the Clock..... 156
 - Shift Lever..... 406, 411, 420
 - Shift Lever Position Indicator..... 86, 407
 - Shift Up/Down Indicator..... 97
 - Shifting (Transmission)..... 406, 411, 420
 - Shoulder Anchor..... 44
 - Side Airbags..... 56
 - Side Curtain Airbags..... 58
 - Spare Tyre..... 603, 653, 656
 - Spark Plugs..... 652
 - Specifications..... 652
 - Specified Fuel..... 522, 523
 - Speed Limiter, Adjustable..... 435
 - Speedometer..... 128
 - SRS Airbags (Airbags)..... 51
 - START/STOP Button..... 185
 - Starting the Engine..... 397, 400
 - Does Not Start..... 621
 - Engine Switch Buzzer..... 186
 - Jump Starting..... 625
 - Steering Wheel
 - Adjusting..... 205
 - Stopping..... 507
 - Sunglasses Holder..... 230
 - Super Locking..... 179
 - Supplemental Restraint System (SRS)..... 51
 - Switches (Around the Steering Wheel)..... 2, 3, 4, 184
 - System Message Indicator..... 95

T

Tachometer	128
Tailgate	
Opening/Closing	169
Unable to Open	649
Temperature	
Outside Temperature Display	131
Temperature Sensor	238
Temporary Repair Kit (TRK)	611
Tie-down Anchors	229
Time (Setting).....	156
Tools	602
Towing a Trailer	388
Equipment and Accessories.....	390
Load Limits	388
Trailer Stability Assist.....	391
Towing Your Vehicle	
Emergency.....	647
Traffic Sign Recognition System	463
Small Icons On and Off	469
Trailer Stability Assist.....	391
Transmission.....	406, 411, 420
Automatic.....	405, 406, 411
Fluid	558, 559
Gear Position Indicator.....	88, 413
M (Sequential Shift Mode) Indicator	88
Manual	420
Number	658
Sequential Shift Mode.....	408
Shift Lever Position Indicator	86, 407
Trip Meter	130

TRK (Temporary Repair Kit).....	611
Troubleshooting	601
Blown Fuse.....	639, 642, 643, 645
Brake Pedal Vibrates	27
Buzzer Sounds When Opening Door.....	28
Emergency Towing	647
Engine Won't Start	621
Noise When Braking	29
Overheating	631
Puncture/Flat Tyre	611
Rear Door Won't Open	28
Select Lever Won't Move	628
Warning Indicators	84
Turn signals.....	189
Indicators (Instrument Panel).....	95
Tyres	580
Air Pressure	653, 656
Checking and Maintaining.....	580
Inspection.....	580
Rotation	583
Spare Tyre	603, 653, 656
Temporary Repair Kit (TRK)	611
Tyre Chains	584
Wear Indicators	581
Winter	584

U

Ultrasonic Sensors.....	178
Unlocking the Doors	161

Unlocking the Front Doors from the Inside.....	167
USB Adapter	240, 241
USB Flash Drives	320
USB Port(s)	242

V

Vanity Mirrors.....	7
Vehicle Identification Numbers.....	658
Vehicle Stability Assist (VSA)	478
Ventilation.....	234
Viscosity (Oil).....	547, 653, 656
VSA (Vehicle Stability Assist)	478
OFF Indicator.....	92
Off Switch.....	479
System Indicator.....	92

W

Wallpaper	143, 150
Warning and Information Messages.....	108
Warning Indicator On/Blinking	633
Warning Labels.....	82
Watts.....	652, 655
Wear Indicators (Tyre).....	581
Window Washers	
Adding/Refilling Fluid	561
Switch.....	197
Windows (Opening and Closing)	180

Windscreen

Cleaning 597
Defrosting/Defogging 235
Washer Fluid 561
Wiper Blades 576
Wipers and Washers 197

Winter Tyres

Tyre Chains 584

Wipers and Washers 197

Checking and Replacing Wiper Blades 576

WMA 259, 265, 302

Worn Tyres 580